

STANLEY
FATMAX **V20**
LITHIUM ION

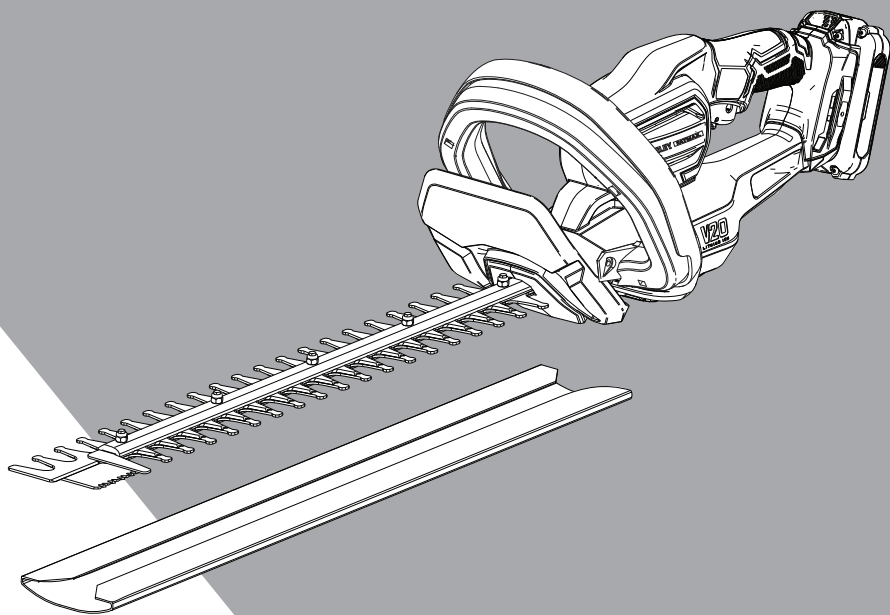

SFMCHT855

Fig. A

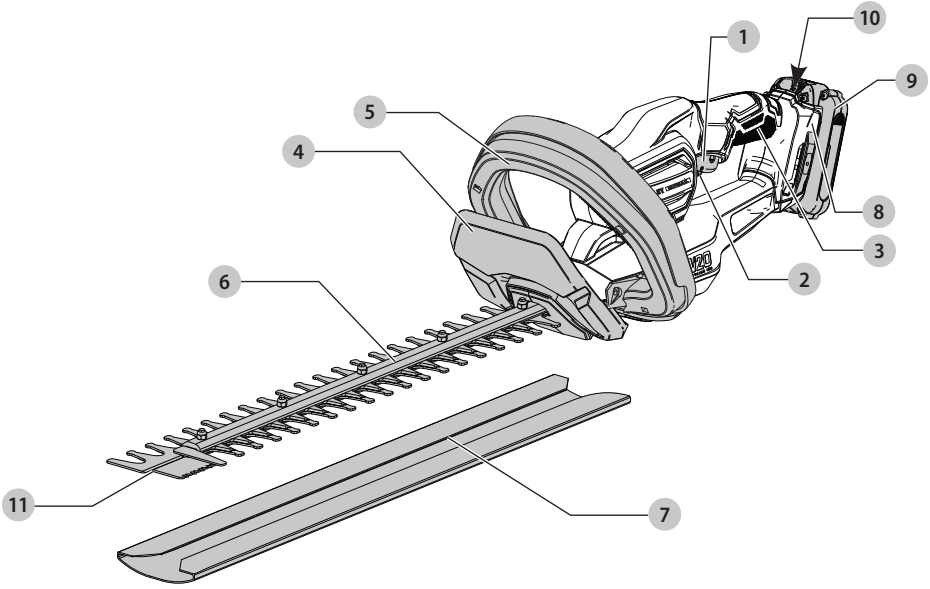

Fig. B

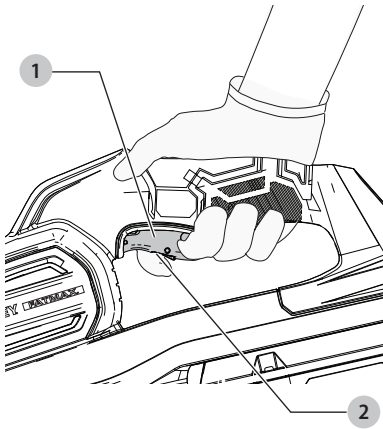

Fig. C

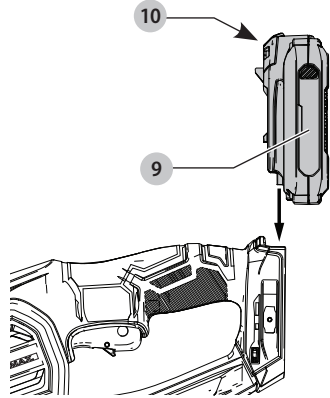

Fig. D

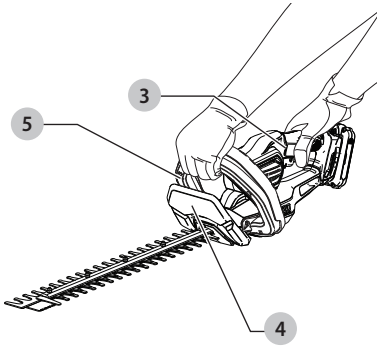

Fig. E

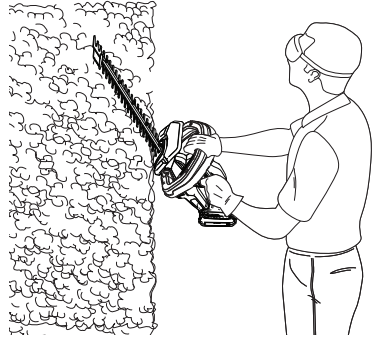

Fig. F

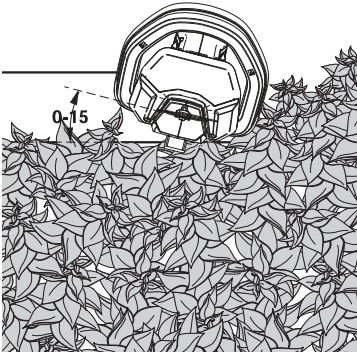

Fig. G

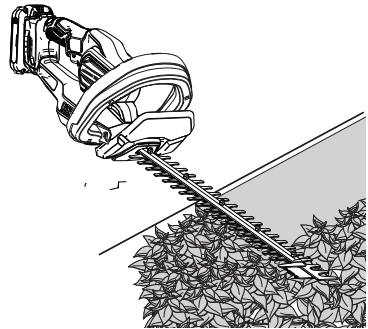

Fig. H

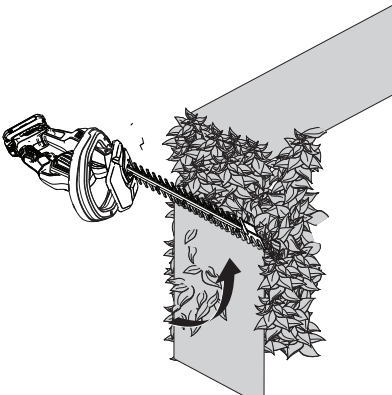

Fig. I

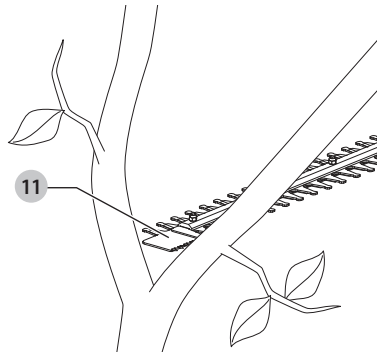

Fig. J

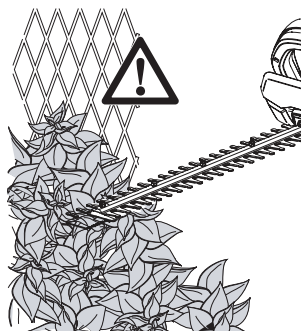
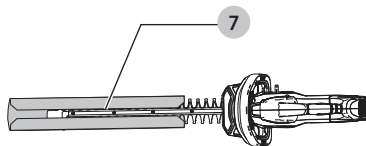

Fig. K



HEDGE TRIMMER

SFMCHT855

Congratulations!

You have chosen a STANLEY FATMAX tool. Years of experience, thorough product development and innovation make STANLEY FATMAX one of the most reliable partners for professional power tool users.

Technical Data

Batteries & Chargers sold separately

SFMCHT855		
Voltage	V _{DC}	18
UK & Ireland	V _{DC}	18
Type		1
RPM		1400
Blade length	mm	550
Cut capacity	mm	19
Weight (without battery pack)	kg	2.9

Noise values and vibration values (triaux vector sum) according to EN60745-2-15:2009 + A1:2010

L _{PA} (emission sound pressure level)	dB(A)	78.5
L _{WA} (sound power level)	dB(A)	90.0
K (uncertainty for the given sound level)	dB(A)	1,8
Vibration emission value a _h =	m/s ²	3.4
Uncertainty K =	m/s ²	1.5

The vibration emission level given in this information sheet has been measured in accordance with a standardised test given in EN60745 and may be used to compare one tool with another. It may be used for a preliminary assessment of exposure.



WARNING: The declared vibration emission level represents the main applications of the tool. However if the tool is used for different applications, with different accessories or poorly maintained, the vibration emission may differ. This may significantly increase the exposure level over the total working period.

An estimation of the level of exposure to vibration should also take into account the times when the tool is switched off or when it is running but not actually doing the job. This may significantly reduce the exposure level over the total working period.

Identify additional safety measures to protect the operator from the effects of vibration such as: maintain the tool and the accessories, keep the hands warm, organisation of work patterns.

Battery Cat #	Output Voltage	Charger SFMCB12
SFMCB202	18	X
SFMCB204	18	X
SFMCB206	18	X

"X" Indicates that the battery pack is compatible with that specific charger. Read the instruction manual for more specific information.

EC-Declaration of Conformity

Machinery Directive



Hedge Trimmer SFMCHT855

STANLEY FATMAX declares that these products described under **Technical Data** are in compliance with: 2006/42/EC, EN60745-1:2009+A11:2010, EN60745-2-15:2009 + A1:2010.

2000/14/EC Hedge Trimmer, Annex V

L_{PA} (measured sound power) 78.5 dB(A)
uncertainty (K) = 2.5 dB (A)

L_{WA} (guaranteed sound power) 92 dB(A)

These products also comply with Directive 2014/30/EU and 2011/65/EU. For more information, please contact STANLEY FATMAX at the following address or refer to the back of the manual.

The undersigned is responsible for compilation of the technical file and makes this declaration on behalf of STANLEY FATMAX.

A. P. Smith

Technical Director

STANLEY FATMAX Europe, Egide Walschaertsstraat14-18,
2800 Mechelen, Belgium
22.08.2019



WARNING: To reduce the risk of injury, read the instruction manual.

Definitions: Safety Guidelines

The definitions below describe the level of severity for each signal word. Please read the manual and pay attention to these symbols.



DANGER: Indicates an imminently hazardous situation which, if not avoided, **will** result in **death or serious injury**.

 **WARNING:** Indicates a potentially hazardous situation which, if not avoided, **could** result in **death or serious injury**.

 **CAUTION:** Indicates a potentially hazardous situation which, if not avoided, **may** result in **minor or moderate injury**.

NOTICE: Indicates a practice **not related to personal injury** which, if not avoided, **may** result in **property damage**.

 Denotes risk of electric shock.

 Denotes risk of fire.

General Power Tool Safety Warnings

 **WARNING:** Read all safety warnings and all instructions. Failure to follow the warnings and instructions may result in electric shock, fire and/or serious injury.

SAVE ALL WARNINGS AND INSTRUCTIONS FOR FUTURE REFERENCE

The term “power tool” in the warnings refers to your mains-operated (corded) power tool or battery-operated (cordless) power tool.

1) Work area safety

- Keep work area clean and well lit.** Cluttered or dark areas invite accidents.
- Do not operate power tools in explosive atmospheres, such as in the presence of flammable liquids, gases or dust.** Power tools create sparks which may ignite the dust or fumes.
- Keep children and bystanders away while operating a power tool.** Distractions can cause you to lose control.

2) Electrical safety

- Power tool plugs must match the outlet. Never modify the plug in any way. Do not use any adapter plugs with earthed (grounded) power tools.** Unmodified plugs and matching outlets will reduce risk of electric shock.
- Avoid body contact with earthed or grounded surfaces such as pipes, radiators, ranges and refrigerators.** There is an increased risk of electric shock if your body is earthed or grounded.
- Do not expose power tools to rain or wet conditions.** Water entering a power tool will increase the risk of electric shock.
- Do not abuse the cord. Never use the cord for carrying, pulling or unplugging the power tool. Keep cord away from heat, oil, sharp edges or moving parts.** Damaged or entangled cords increase the risk of electric shock.

- When operating a power tool outdoors, use an extension cord suitable for outdoor use.** Use of a cord suitable for outdoor use reduces the risk of electric shock.
- If operating a power tool in a damp location is unavoidable, use a residual current device (RCD) protected supply.** Use of an RCD reduces the risk of electric shock.

3) Personal safety

- Stay alert, watch what you are doing and use common sense when operating a power tool. Do not use a power tool while you are tired or under the influence of drugs, alcohol or medication.** A moment of inattention while operating power tools may result in serious personal injury.
- Use personal protective equipment. Always wear eye protection.** Protective equipment such as dust mask, non-skid safety shoes, hard hat, or hearing protection used for appropriate conditions will reduce personal injuries.
- Prevent unintentional starting. Ensure the switch is in the off position before connecting to power source and/or battery pack, picking up or carrying the tool.** Carrying power tools with your finger on the switch or energising power tools that have the switch on invites accidents.
- Remove any adjusting key or wrench before turning the power tool on.** A wrench or a key left attached to a rotating part of the power tool may result in personal injury.
- Do not overreach. Keep proper footing and balance at all times.** This enables better control of the power tool in unexpected situations.
- Dress properly. Do not wear loose clothing or jewellery. Keep your hair, clothing and gloves away from moving parts.** Loose clothes, jewellery or long hair can be caught in moving parts.
- If devices are provided for the connection of dust extraction and collection facilities, ensure these are connected and properly used.** Use of dust collection can reduce dust-related hazards.

4) Power tool use and care

- Do not force the power tool. Use the correct power tool for your application.** The correct power tool will do the job better and safer at the rate for which it was designed.
- Do not use the power tool if the switch does not turn it on and off.** Any power tool that cannot be controlled with the switch is dangerous and must be repaired.
- Disconnect the plug from the power source and/or the battery pack from the power tool before making any adjustments, changing accessories, or storing power tools.** Such preventive safety measures reduce the risk of starting the power tool accidentally.
- Store idle power tools out of the reach of children and do not allow persons unfamiliar with the power**

tool or these instructions to operate the power tool.

Power tools are dangerous in the hands of untrained users.

- e) **Maintain power tools. Check for misalignment or binding of moving parts, breakage of parts and any other condition that may affect the power tool's operation. If damaged, have the power tool repaired before use.** Many accidents are caused by poorly maintained power tools.
- f) **Keep cutting tools sharp and clean.** Properly maintained cutting tools with sharp cutting edges are less likely to bind and are easier to control.
- g) **Use the power tool, accessories and tool bits etc., in accordance with these instructions taking into account the working conditions and the work to be performed.** Use of the power tool for operations different from those intended could result in a hazardous situation.

5) Battery tool use and care

- a) **Recharge only with the charger specified by the manufacturer.** A charger that is suitable for one type of battery pack may create a risk of fire when used with another battery pack.
- b) **Use power tools only with specifically designated battery packs.** Use of any other battery packs may create a risk of injury and fire.
- c) **When battery pack is not in use, keep it away from other metal objects like paper clips, coins, keys, nails, screws or other small metal objects that can make a connection from one terminal to another.** Shorting the battery terminals together may cause burns or a fire.
- d) **Under abusive conditions, liquid may be ejected from the battery; avoid contact. If contact accidentally occurs, flush with water. If liquid contacts eyes, additionally seek medical help.** Liquid ejected from the battery may cause irritation or burns.

6) Service

- a) **Have your power tool serviced by a qualified repair person using only identical replacement parts.** This will ensure that the safety of the power tool is maintained.

Additional Safety Instructions for

Hedge Trimmers



WARNING: Cutting elements continue to rotate after the motor is switched off.

- **Keep all parts of the body away from the cutter blade. Do not remove cut material or hold material to be cut when blades are moving. Make sure the switch is off when clearing jammed material.** A moment of inattention while operating the tool can result in serious personal injury.
- **Carry the hedge trimmer by the handle with the cutter blade stopped. When transporting or storing the hedge trimmer always fit the cutting device cover.** Proper handling of the hedge trimmer will reduce possible personal injury from the cutter blades.

- **Hold the power tool by insulated gripping surfaces only, because the cutter blade may contact hidden wiring.** Cutter blades contacting a "live" wire may make exposed metal parts of the power tool "live" and could give the operator an electric shock.
- The intended use is described in this instruction manual. The use of any accessory or attachment or performance of any operation with this tool other than those recommended in this instruction manual can present a risk of personal injury and/or damage to property.
- Do not carry the tool with your hands on the front handle, switch or the trigger switch unless the battery has been removed.
- If you have not used a hedge trimmer before, preferably seek practical instruction by an experienced user in addition to studying this manual.
- Never touch the blades while the tool is running.
- Never attempt to force the blades to come to a standstill. u Do not put the tool down until the blades have come to a complete standstill.
- Regularly check the blades for damage and wear. Do not use the tool when the blades are damaged.
- Take care to avoid hard objects (e.g. metal wire, railings) when trimming. Should you accidentally hit any such object, immediately switch the tool off and check for any damage.
- Should the tool start to vibrate abnormally, immediately switch it off and remove the battery then check for any damage.
- If the tool stalls, immediately switch it off. Remove the battery before attempting to remove any obstructions.
- After use, place the blade sheath supplied over the blades. Store the tool, making sure that the blade is not exposed.
- Always ensure that all guards are fitted when using the tool. Never attempt to use an incomplete tool or a tool with unauthorised modifications.
- Never allow children to use the tool.
- Be aware of falling debris when cutting the higher sides of a hedge.
- Always hold the tool with both hands and by the handles provided.

Residual Risks

Additional residual risks may arise when using the tool which may not be included in the enclosed safety warnings. These risks can arise from misuse, prolonged use etc.

Even with the application of the relevant safety regulations and the implementation of safety devices, certain residual risks can not be avoided. These include:

- Injuries caused by touching any rotating/moving parts.
- Injuries caused when changing any parts, blades or accessories.
- Injuries caused by prolonged use of a tool. When using any tool for prolonged periods ensure you take regular breaks.
- Impairment of hearing.

- Health hazards caused by breathing dust developed when using your tool (example: working with wood, especially oak, beech and MDF)

Electrical Safety

The electric motor has been designed for one voltage only. Always check that the battery pack voltage corresponds to the voltage on the rating plate. Also make sure that the voltage of your charger corresponds to that of your mains.



Your STANLEY FATMAX charger is double insulated in accordance with EN60335; therefore no earth wire is required.



WARNING: 115 V units have to be operated via a fail-safe isolating transformer with an earth screen between the primary and secondary winding.

If the supply cord is damaged, it must be replaced by a specially prepared cord available through the STANLEY FATMAX service organisation.

Mains Plug Replacement (U.K. & Ireland Only)

If a new mains plug needs to be fitted:

- Safely dispose of the old plug.
- Connect the brown lead to the live terminal in the plug.
- Connect the blue lead to the neutral terminal.



WARNING: No connection is to be made to the earth terminal.

Follow the fitting instructions supplied with good quality plugs. Recommended fuse: 3 A.

Using an Extension Cable

An extension cord should not be used unless absolutely necessary. Use an approved extension cable suitable for the power input of your charger (see **Technical Data**). The minimum conductor size is 1 mm²; the maximum length is 30 m.

When using a cable reel, always unwind the cable completely.

SAVE THESE INSTRUCTIONS

Chargers

STANLEY FATMAX chargers require no adjustment and are designed to be as easy as possible to operate.

Important Safety Instructions for All Battery Chargers

SAVE THESE INSTRUCTIONS: This manual contains important safety and operating instructions for compatible battery chargers (refer to **Technical Data**).

- Before using charger, read all instructions and cautionary markings on charger, battery pack, and product using battery pack.



WARNING: Shock hazard. Do not allow any liquid to get inside charger. Electric shock may result.



WARNING: We recommend the use of a residual current device with a residual current rating of 30mA or less.



CAUTION: Burn hazard. To reduce the risk of injury, charge only STANLEY FATMAX rechargeable batteries. Other types of batteries may burst causing personal injury and damage.



CAUTION: Children should be supervised to ensure that they do not play with the appliance.

NOTICE: Under certain conditions, with the charger plugged into the power supply, the exposed charging contacts inside the charger can be shorted by foreign material. Foreign materials of a conductive nature such as, but not limited to, steel wool, aluminum foil or any buildup of metallic particles should be kept away from charger cavities. Always unplug the charger from the power supply when there is no battery pack in the cavity. Unplug charger before attempting to clean

- **DO NOT attempt to charge the battery pack with any chargers other than the ones in this manual.** The charger and battery pack are specifically designed to work together.
- **These chargers are not intended for any uses other than charging STANLEY FATMAX rechargeable batteries.** Any other uses may result in risk of fire, electric shock or electrocution.
- **Do not expose charger to rain or snow.**
- **Pull by plug rather than cord when disconnecting charger.** This will reduce risk of damage to electric plug and cord.
- **Make sure that cord is located so that it will not be stepped on, tripped over, or otherwise subjected to damage or stress.**
- **Do not use an extension cord unless it is absolutely necessary.** Use of improper extension cord could result in risk of fire, electric shock, or electrocution.
- **Do not place any object on top of charger or place the charger on a soft surface that might block the ventilation slots and result in excessive internal heat.** Place the charger in a position away from any heat source. The charger is ventilated through slots in the top and the bottom of the housing.
- **Do not operate charger with damaged cord or plug—** have them replaced immediately.
- **Do not operate charger if it has received a sharp blow, been dropped, or otherwise damaged in any way.** Take it to an authorised service centre.
- **Do not disassemble charger; take it to an authorised service centre when service or repair is required.** Incorrect reassembly may result in a risk of electric shock, electrocution or fire.
- In case of damaged power supply cord the supply cord must be replaced immediately by the manufacturer, its service agent or similar qualified person to prevent any hazard.
- **Disconnect the charger from the outlet before attempting any cleaning. This will reduce the risk of electric shock.** Removing the battery pack will not reduce this risk.
- **NEVER attempt to connect two chargers together.**

- **The charger is designed to operate on standard 230V household electrical power. Do not attempt to use it on any other voltage. This does not apply to the vehicular charger.**









Charging a Battery (Fig. A)

1. Plug the charger into an appropriate outlet before inserting battery pack.
2. Insert the battery pack **9** into the charger, making sure the battery pack is fully seated in the charger. The red (charging) light will blink repeatedly indicating that the charging process has started.
3. The completion of charge will be indicated by the red light remaining ON continuously. The battery pack is fully charged and may be used at this time or left in the charger. To remove the battery pack from the charger, push the battery release button **10** on the battery pack.

NOTE: To ensure maximum performance and life of lithium-ion battery packs, charge the battery pack fully before first use.

Charger Operation

Refer to the indicators below for the charge status of the battery pack.

Charge Indicators	
 Charging	 
 Fully Charged	 
 Hot/Cold Pack Delay*	 

This charger is designed to detect certain problems that can arise. Problems are indicated by the red light flashing at a fast rate. If this occurs, remove and then reinsert the battery pack into the charger. If the problem persists, try a different battery pack to determine if the charger is working properly. If the new pack charges correctly, then the original pack is defective and should be returned to a service center or other collection site for recycling. If the new battery pack elicits the same trouble indication as the original, have the charger and the battery pack tested at an authorized service center.

The compatible charger(s) will not charge a faulty battery pack. The charger will indicate faulty battery by refusing to light or by displaying problem pack or charger blink pattern.

NOTE: This could also mean a problem with a charger.

If the charger indicates a problem, take the charger and battery pack to be tested at an authorised service centre.

Hot/Cold Pack Delay

When the charger detects a battery pack that is too hot or too cold, it automatically starts a Hot/Cold Pack Delay, suspending charging until the battery pack has reached an appropriate temperature. The charger then automatically switches to the pack charging mode. This feature ensures maximum battery pack life.

A cold battery pack will charge at a slower rate than a warm battery pack. The battery pack will charge at that slower rate throughout the entire charging cycle and will not return to maximum charge rate even if the battery pack warms.

Charger Cleaning Instructions



WARNING: Shock hazard. Disconnect the charger from the AC outlet before cleaning. Dirt and grease may be removed from the exterior of the charger using a cloth or soft non-metallic brush. Do not use water or any cleaning solutions. Never let any liquid get inside the tool; never immerse any part of the tool into a liquid.

Battery Packs

Important Safety Instructions for All Battery Packs

When ordering replacement battery packs, be sure to include catalog number and voltage.

The battery pack is not fully charged out of the carton. Before using the battery pack and charger, read the safety instructions below. Then follow charging procedures outlined.

READ ALL INSTRUCTIONS

- **Do not charge or use battery in explosive atmospheres, such as in the presence of flammable liquids, gases or dust.** Inserting or removing the battery from the charger may ignite the dust or fumes.
- **Never force battery pack into charger. Do not modify battery pack in any way to fit into a non-compatible charger as battery pack may rupture causing serious personal injury.**
- Charge the battery packs only in STANLEY FATMAX chargers.
- **DO NOT splash or immerse in water or other liquids.**
- **Do not store or use the tool and battery pack in locations where the temperature may reach or exceed 40 °C (104 °F) (such as outside sheds or metal buildings in summer).**
- **Do not incinerate the battery pack even if it is severely damaged or is completely worn out.** The battery pack can explode in a fire. Toxic fumes and materials are created when lithium-ion battery packs are burned.
- **If battery contents come into contact with the skin, immediately wash area with mild soap and water.** If battery liquid gets into the eye, rinse water over the open eye for 15 minutes or until irritation ceases. If medical attention is needed, the battery electrolyte is composed of a mixture of liquid organic carbonates and lithium salts.
- **Contents of opened battery cells may cause respiratory irritation.** Provide fresh air. If symptoms persists, seek medical attention.



WARNING: Burn hazard. Battery liquid may be flammable if exposed to spark or flame.



WARNING: Never attempt to open the battery pack for any reason. If battery pack case is cracked or damaged, do not insert into charger. Do not crush, drop or damage battery pack. Do not use a battery pack or charger that has received a sharp blow, been dropped, run over or damaged in any way (i.e., pierced with a nail, hit with a hammer, stepped on). Electric shock or electrocution

may result. Damaged battery packs should be returned to service centre for recycling.



WARNING: Fire hazard. Do not store or carry the battery pack so that metal objects can contact exposed battery terminals. For example, do not place the battery pack in aprons, pockets, tool boxes, product kit boxes, drawers, etc., with loose nails, screws, keys, etc.



CAUTION: When not in use, place tool on its side on a stable surface where it will not cause a tripping or falling hazard. Some tools with large battery packs will stand upright on the battery pack but may be easily knocked over.

Transportation



WARNING: Fire hazard. Transporting batteries can possibly cause fire if the battery terminals inadvertently come in contact with conductive materials. When transporting batteries, make sure that the battery terminals are protected and well insulated from materials that could contact them and cause a short circuit.

NOTE: Lithium-ion batteries should not be put in checked baggage.

STANLEY FATMAX batteries comply with all applicable shipping regulations as prescribed by industry and legal standards which include UN Recommendations on the Transport of Dangerous Goods; International Air Transport Association (IATA) Dangerous Goods Regulations, International Maritime Dangerous Goods (IMDG) Regulations, and the European Agreement Concerning The International Carriage of Dangerous Goods by Road (ADR). Lithium-ion cells and batteries have been tested to section 38.3 of the UN Recommendations on the Transport of Dangerous Goods Manual of Tests and Criteria.

In most instances, shipping a STANLEY FATMAX battery pack will be excepted from being classified as a fully regulated Class 9 Hazardous Material. In general, only shipments containing a lithium-ion battery with an energy rating greater than 100 Watt Hours (Wh) will require being shipped as fully regulated Class 9. All lithium-ion batteries have the Watt Hour rating marked on the pack. Furthermore, due to regulation complexities, STANLEY FATMAX does not recommend air shipping lithium-ion battery packs alone regardless of Watt Hour rating. Shipments of tools with batteries (combo kits) can be air shipped as excepted if the Watt Hour rating of the battery pack is no greater than 100 Whr.

Regardless of whether a shipment is considered excepted or fully regulated, it is the shipper's responsibility to consult the latest regulations for packaging, labeling/markings and documentation requirements.

The information provided in this section of the manual is provided in good faith and believed to be accurate at the time the document was created. However, no warranty, expressed or implied, is given. It is the buyer's responsibility to ensure that its activities comply with the applicable regulations.

Storage Recommendations

1. The best storage place is one that is cool and dry away from direct sunlight and excess heat or cold. For optimum

battery performance and life, store battery packs at room temperature when not in use.

2. For long storage, it is recommended to store a fully charged battery pack in a cool, dry place out of the charger for optimal results.

NOTE: Battery packs should not be stored completely depleted of charge. The battery pack will need to be recharged before use.

Labels on Charger and Battery Pack

In addition to the pictographs used in this manual, the labels on the charger and the battery pack may show the following pictographs:



Read instruction manual before use.



See **Technical Data** for charging time.



Do not probe with conductive objects.



Do not charge damaged battery packs.



Do not expose to water.



Have defective cords replaced immediately.



Charge only between 4 °C and 40 °C.



Only for indoor use.



Discard the battery pack with due care for the environment.

LI-ION



Charge STANLEY FATMAX battery packs only with designated STANLEY FATMAX chargers. Charging battery packs other than the designated STANLEY FATMAX batteries with a STANLEY FATMAX charger may make them burst or lead to other dangerous situations.



Do not incinerate the battery pack.

Battery Type

The SFMCHT855 operates on a 18 volt battery pack.

These battery packs may be used: SFMCB202, SFMCB204, SFMCB206. Refer to **Technical Data** for more information.

Package Contents

The package contains:

- 1 Hedge Trimmer
- 1 Sheath

- 1 Battery
- 1 Charger
- 1 Instruction manual
- Check for damage to the tool, parts or accessories which may have occurred during transport.
- Take the time to thoroughly read and understand this manual prior to operation.

Markings on Tool

The following pictograms are shown on the tool:



Read instruction manual before use.



Wear ear protection.



Wear eye protection.



Do not expose the tool to rain or high humidity or leave outdoors while it is raining.



Switch the tool off. Before performing any maintenance on the tool, remove the battery from the tool.



Keep bystanders away.



Directive 2000/14/EC guaranteed sound power.

Date Code Position

The date code, which also includes the year of manufacture, is printed into the housing.

Example:

2019 XX XX

Year of Manufacture

Description (Fig. A)

WARNING: Never modify the power tool or any part of it. Damage or personal injury could result.

- 1 Trigger switch
- 2 Lock-off switch
- 3 Switch handle
- 4 Blade guard
- 5 Bail handle
- 6 Blade
- 7 Sheath
- 8 Battery housing

- 9 Battery pack
- 10 Battery release button
- 11 Powersaw

Intended Use

Your STANLEY FATMAX, SFMCHT855 hedge trimmer has been designed for trimming hedges and shrubs. This tool is intended for professional use only.

DO NOT use under wet conditions or in the presence of flammable liquids or gases.

DO NOT let children come into contact with the tool. Supervision is required when inexperienced operators use this tool.

- **Young children and the infirm.** This appliance is not intended for use by young children or infirm persons without supervision.
- This product is not intended for use by persons (including children) suffering from diminished physical, sensory or mental abilities; lack of experience, knowledge or skills unless they are supervised by a person responsible for their safety. Children should never be left alone with this product.

ASSEMBLY AND ADJUSTMENTS



WARNING: To reduce the risk of serious personal injury, turn tool off and disconnect battery pack before making any adjustments or removing/ installing attachments or accessories. An accidental start-up can cause injury.



WARNING: Use only STANLEY FATMAX battery packs and chargers.

Installing and Removing the Battery Pack (Fig. C)

NOTE: For best results, make sure your battery pack is fully charged.

To install the battery pack **9** into the tool handle, align the battery pack with the rails inside the tool's handle and slide it into the handle until the battery pack is firmly seated in the tool and ensure that it does not disengage.

To remove the battery pack from the tool, press the release button **10** and firmly pull the battery pack out of the tool handle. Insert it into the charger as described in the charger section of this manual.

OPERATION

Instructions for Use





WARNING: Always observe the safety instructions and applicable regulations.



WARNING: To reduce the risk of serious personal injury, turn tool off and disconnect battery pack before making any adjustments or removing/ installing attachments or accessories. An accidental start-up can cause injury.

Proper Hand Position (Fig. D)

 **WARNING:** To reduce the risk of serious personal injury, **ALWAYS** use proper hand position as shown.

 **WARNING:** To reduce the risk of serious personal injury, **ALWAYS** hold securely in anticipation of a sudden reaction.

Proper hand position requires one hand on the switch handle **3** and one hand on the bail handle **5**. Never hold the unit by the blade guard **4**.

Switch (Fig. A, B)

To turn the unit on, push the lock-off switch **2** forward as shown in Figure B, and squeeze the trigger switch **1**. Once the unit is running, you may release the lock off switch.

In order to keep the unit running you must continue to squeeze the trigger. To turn the unit off, fully release the trigger and allow the lock-off switch to engage.

 **WARNING:** Never attempt to lock a switch in the **ON** position.

 **WARNING:** Do not cut stems greater than 19 mm. Use the trimmer only for cutting normal shrubbery around houses and buildings.

Trimming Instructions

- WORKING POSITION (Fig. E)** – Maintain proper footing and balance and do not overreach. Wear safety goggles, non-skid footwear when trimming. Hold the unit firmly in both hands and turn the unit on. Refer to **Proper Hand Position** for further information.
- TRIMMING NEW GROWTH (Fig. F)** – Using a wide, sweeping motion and feeding the blade teeth through the twigs, is most effective. A slight downward tilt of the blade in the direction of motion gives the best cutting.
- LEVEL HEDGES (Fig. G)** – To obtain exceptionally level hedges a piece of string can be stretched along the length of the hedge as a guide.
- SIDE TRIMMING HEDGES (Fig. H)** – Orient the trimmer as shown and begin at the bottom and sweep up.
- POWERSAW (Fig. I)** – For branches too large for the blade to cut, use the powersaw **11**. Position the powersaw as close to the bottom of the branch as possible. Place the powersaw shoe against the branch. Turn the hedge trimmer on as described above, allowing the tool to work at its own pace until the branch is fully cut.

 **DANGER:** KEEP HANDS AWAY FROM BLADES.

 **WARNING:** To guard against injury, observe the following:

- READ INSTRUCTION MANUAL BEFORE USING. SAVE INSTRUCTION MANUAL.
- Check the hedge for foreign objects such as wires or fences before each use.
- KEEP HANDS ON HANDLES. DON'T OVERREACH.
- DO NOT USE UNDER WET CONDITIONS.

 **CAUTION:** BLADE MAY COAST AFTER TURN OFF.

MAINTENANCE

Your STANLEY FATMAX power tool has been designed to operate over a long period of time with a minimum of maintenance. Continuous satisfactory operation depends upon proper tool care and regular cleaning.

 **WARNING:** To reduce the risk of serious personal injury, turn tool off and disconnect battery pack before making any adjustments or removing/installing attachments or accessories. An accidental start-up can cause injury.

The charger and battery pack are not serviceable.

Blade Maintenance (Fig. J)

The cutting blades are made from high quality, hardened steel and with normal usage, they will not require resharpening. However, if you accidentally hit a wire fence (Fig. J), stones, glass, or other hard objects, you may put a nick in the blade. There is no need to remove this nick as long as it does not interfere with the movement of the blade. If it does interfere, remove the battery and use a fine toothed file or sharpening stone to remove the nick. If you drop the trimmer, carefully inspect it for damage. If the blade is bent, housing cracked, handles broken or if you see any other condition that may affect the trimmer's operation contact your local authorized service center for repairs before putting it back into use.

Blade Lubrication (Fig. K)

- After use, remove the battery.
- Carefully apply a resin solvent to the exposed blades.
- Insert the battery and turn the trimmer vertical with the blades toward the ground and run the trimmer for a few seconds to fully disperse the lubrication.
- Keeping your hands away from the blade, slide the sheath **7** over the blade until it snaps into place as shown in Figure K.

Storage

Fertilizers and other garden chemicals contain agents which greatly accelerate the corrosion of metals. Do not store the unit on or adjacent to fertilizers or chemicals.



Cleaning

 **WARNING:** Blow dirt and dust out of the main housing with dry air as often as dirt is seen collecting in and around the air vents. Wear approved eye protection and approved dust mask when performing this procedure.

 **WARNING:** Never use solvents or other harsh chemicals for cleaning the non-metallic parts of the tool. These chemicals may weaken the materials used in these parts. Use a cloth dampened only with water and mild soap. Never let any liquid get inside the tool; never immerse any part of the tool into a liquid.

Optional Accessories



WARNING: *Since accessories, other than those offered by STANLEY FATMAX, have not been tested with this product, use of such accessories with this tool could be hazardous. To reduce the risk of injury, only STANLEY FATMAX recommended accessories should be used with this product.*

Consult your dealer for further information on the appropriate accessories.

Protecting the Environment



Separate collection. Products and batteries marked with this symbol must not be disposed of with normal household waste.

■ Products and batteries contain materials that can be recovered or recycled reducing the demand for raw materials. Please recycle electrical products and batteries according to local provisions. Further information is available at www.2helpU.com.

Rechargeable Battery Pack

This long life battery pack must be recharged when it fails to produce sufficient power on jobs which were easily done before. At the end of its technical life, discard it with due care for our environment:

- Run the battery pack down completely, then remove it from the tool.
- Li-Ion cells are recyclable. Take them to your dealer or a local recycling station. The collected battery packs will be recycled or disposed of properly.

Australia & New Zealand

Stanley Black & Decker

Stanley Fat Max

www.stanleytools.com.au

Tel.1800 338 002 (Aust) or Tel. 0800 4782 6539 (NZ)

810 Whitehorse Road Box Hill VIC 3128, Australia