

STANLEY

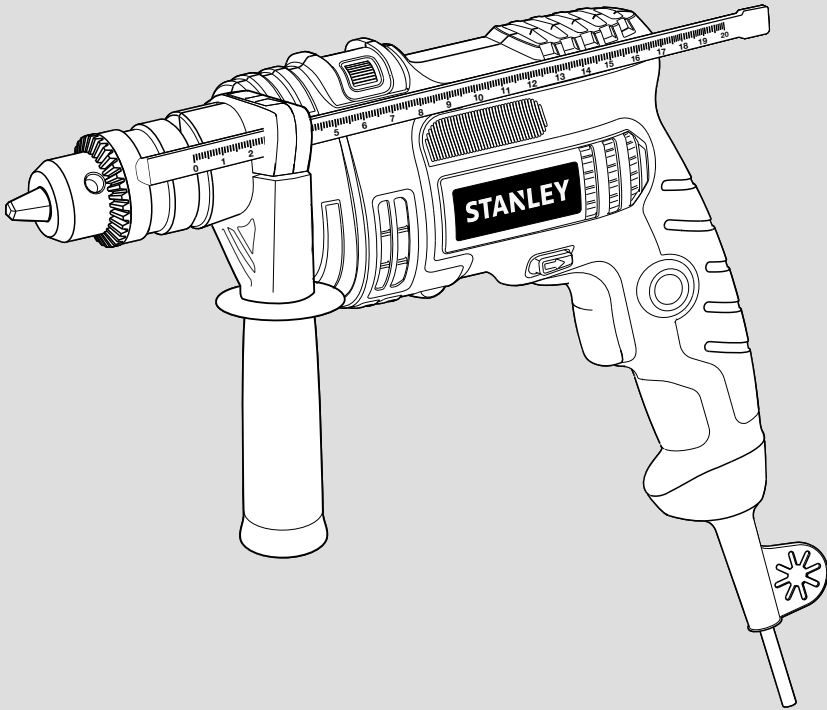

STDH5510
STDH6513

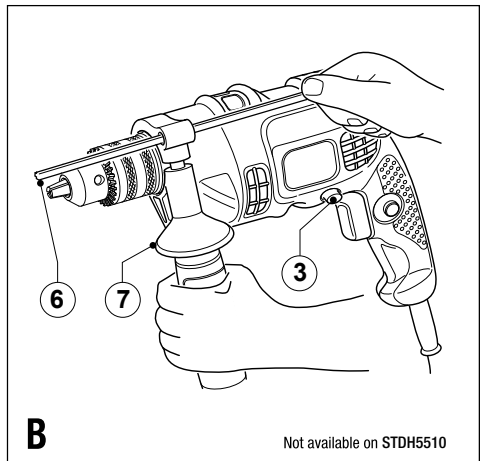

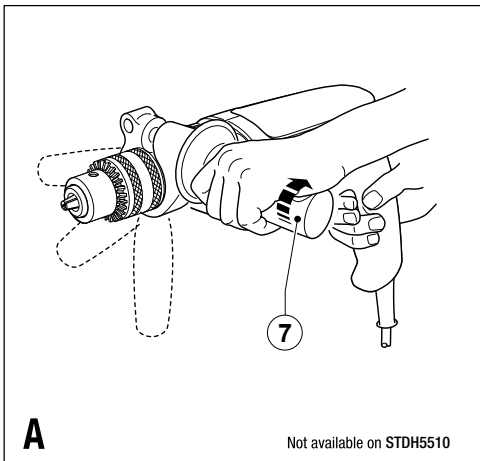
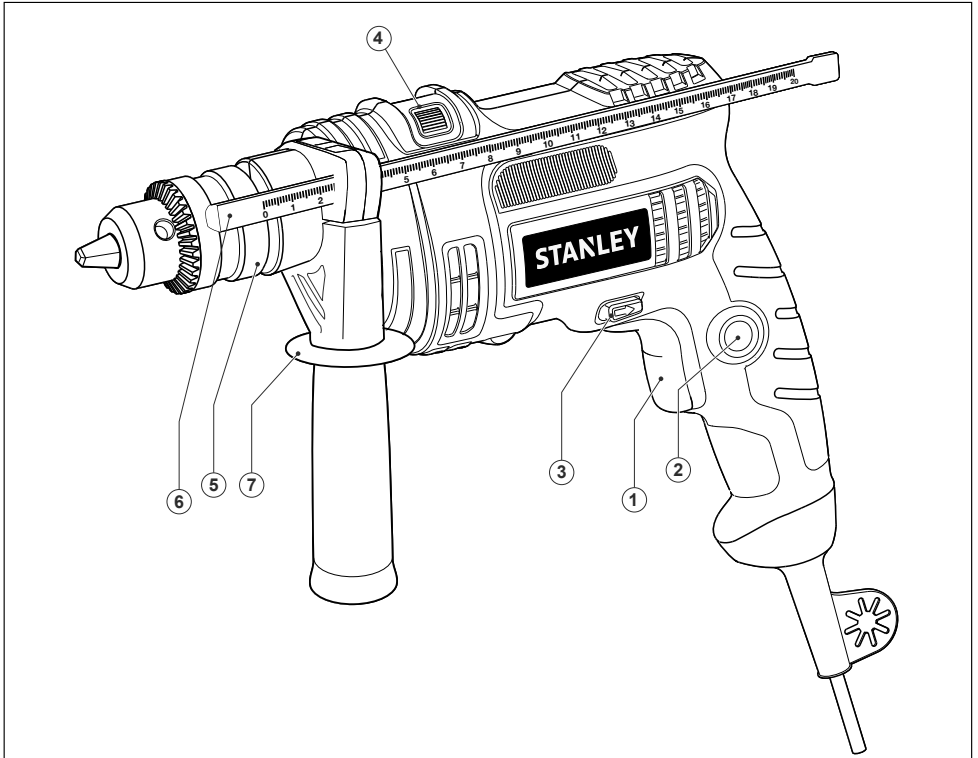
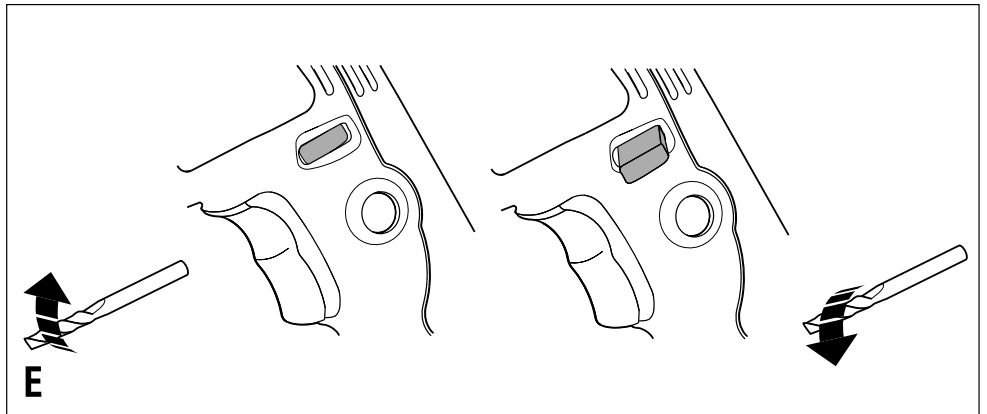
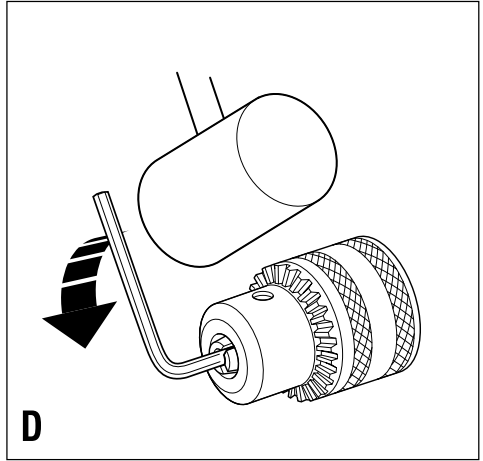
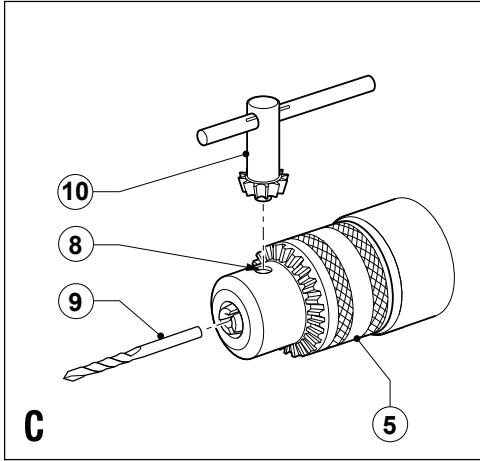

Technical Data

Drill		STDH5510	STDH6513
Power	W	550	650
Voltage	V	220-240	220-240
Fr equency	Hz	50/60	50/60
No Load Speed	/min	0-2800	0-2800
Reverse		Yes	Yes
Max. Drilling Capacity			
Wood/Steel/Masonry	mm	25/10/13	30/13/16
Cable Length	m	2	2

Intended use



Your STANLEY percussion drill has been designed for drilling in wood, metal and plastics and masonry as well as for screwdriving

purposes.

Safety instructions

General power tool safety warnings

WARNING! Read all safety warnings and all instructions. Failure to follow the warnings and instructions listed below may result in electric shock, fire and/or serious injury.

Save all warnings and instructions for future reference.

The term "power tool" in all of the warnings listed below refers to your mains operated (corded) power tool or battery operated (cordless) power tool.

1. Work area safety

- a. **Keep work area clean and well lit.** Cluttered or dark areas invite accidents.
- b. **Do not operate power tools in explosive atmospheres, such as in the presence of flammable liquids, gases or dust.** Power tools create sparks which may ignite the dust or fumes.
- c. **Keep children and bystanders away while operating a power tool.** Distractions can cause you to lose control.

2. Electrical safety

- a. **Power tool plugs must match the outlet. Never modify the plug in any way. Do not use any adapter plugs with earthed (grounded) power tools.** Unmodified plugs and matching outlets will reduce risk of electric shock.

- b. **Avoid body contact with earthed or grounded surfaces such as pipes, radiators, ranges and refrigerators.** There is an increased risk of electric shock if your body is earthed or grounded.
- c. **Do not expose power tools to rain or wet conditions.** Water entering a power tool will increase the risk of electric shock.
- d. **Do not abuse the cord. Never use the cord for carrying, pulling or unplugging the power tool. Keep cord away from heat, oil, sharp edges or moving parts.** Damaged or entangled cords increase the risk of electric shock.
- e. **When operating a power tool outdoors, use an extension cord suitable for outdoor use.** Use of a cord suitable for outdoor use reduces the risk of electric shock.
- f. **If operating a power tool in a damp location is unavoidable, use a residual current device (RCD) protected supply.** Use of an RCD reduces the risk of electric shock.

3. Personal safety







- a. **Stay alert, watch what you are doing and use common sense when operating a power tool. Do not use a power tool while you are tired or under the influence of drugs, alcohol or medication.** A moment of inattention while operating power tools may result in serious personal injury.
- b. **Use personal protective equipment. Always wear eye protection.** Protective equipment such as dust mask, non-skid safety shoes, hard hat, or hearing protection used for appropriate conditions will reduce personal injuries.
- c. **Prevent unintentional starting. Ensure the switch is in the off-position before connecting to power source and/or battery pack, picking up or carrying the tool.** Carrying power tools with your finger on the switch or energising power tools that have the switch on invites accidents.
- d. **Remove any adjusting key or wrench before turning the power tool on.** A wrench or a key left attached to a rotating part of the power tool may result in personal injury.
- e. **Do not overreach. Keep proper footing and balance at all times.** This enables better control of the power tool in unexpected situations.
- f. **Dress properly. Do not wear loose clothing or jewellery. Keep your hair, clothing and gloves away from moving parts.** Loose clothes, jewellery or long hair can be caught in moving parts.

- g. If devices are provided for the connection of dust extraction and collection facilities, ensure these are connected and properly used. Use of dust collection can reduce dust-related hazards.
- 4. Power tool use and care
 - a. Do not force the power tool. Use the correct power tool for your application. The correct power tool will do the job better and safer at the rate for which it was designed.
 - b. Do not use the power tool if the switch does not turn it on and off. Any power tool that cannot be controlled with the switch is dangerous and must be repaired.
 - c. Disconnect the plug from the power source and/or the battery pack from the power tool before making any adjustments, changing accessories, or storing power tools. Such preventive safety measures reduce the risk of starting the power tool accidentally.
 - d. Store idle power tools out of the reach of children and do not allow persons unfamiliar with the power tool or these instructions to operate the power tool. Power tools are dangerous in the hands of untrained users.
 - e. Maintain power tools. Check for misalignment or binding of moving parts, breakage of parts and any other condition that may affect the power tools operation. If damaged, have the power tool repaired before use. Many accidents are caused by poorly maintained power tools.
 - f. Keep cutting tools sharp and clean. Properly maintained cutting tools with sharp cutting edges are less likely to bind and are easier to control.
- g. Use the power tool, accessories and tool bits etc. in accordance with these instructions, taking into account the working conditions and the work to be performed. Use of the power tool for operations different from those intended could result in a hazardous situation.
- 5. Service
 - a. Have your power tool serviced by a qualified repair person using only identical replacement parts. This will ensure that the safety of the power tool is maintained.

- Use auxiliary handles supplied with the tool. Loss of control can cause personal injury.
- Hold power tool by insulated gripping surfaces when performing an operation where the cutting accessory may contact hidden wiring or its own cord. Cutting accessory contacting a "live" wire may make exposed metal parts of the power tool "live" and could give the operator an electric shock.
- Use clamps or another practical way to secure and support the workpiece to a stable platform. Holding the work by hand or against your body leaves it unstable and may lead to loss of control.
- Before drilling into walls, floors or ceilings, check for the location of wiring and pipes.
- Avoid touching the tip of a drill bit just after drilling, as it may be hot.
- This Tool is not intended for use by persons (including children) with reduced physical, sensory or metal capabilities, or lack of experience and knowledge, unless they have been given supervision or instruction concerning use of the appliance by a person responsible for their safety. Children should be supervised to ensure that they do not play with the appliance.
- The intended use is described in this instruction manual. The use of any accessory or attachment or performance of any operation with this tool other than those recommended in this instruction manual may present a risk of personal injury and/or damage to property.

Labels on tool

The label on your tool may include the following symbols:

	Read Instructions Manual	Hz Hertz		Class II Construction
	Use Eye Protection	W Watts		Earthing Terminal
	Use Ear Protection	min minutes		Safety Alert Symbol
		/min..	Revolutions or Reciprocation per minute
		===== Direct Current		
V Volts		n ₀ No-Load Speed		
A Amperes				

Position of date barcode

The Date Code, which also includes the year of manufacture, is printed into the housing. Example:

2014 XX JN
Year of manufacturing

Additional power tool safety warnings



Warning! Additional safety warnings for grinding, sanding, wire brushing, polishing or abrasive cutting/off operations

- **Wear ear protectors.** Exposure to noise can cause hearing loss.

Electrical safety



This tool is double insulated; therefore no earth wire is required. Always check that the power supply corresponds to the voltage on the rating plate.

- If the supply cord is damaged, it must be replaced by the manufacturer or an authorised STANLEY Service Centre in order to avoid a hazard.

Features

This tool includes some or all of the following features.

1. Variable speed switch
2. Lock-on button
3. Forward/reverse button
4. Drilling mode selector
5. Chuck

The following accessories may not be available with your unit

6. Depth stop
7. Side handle (STDH6513 only)

Assembly

Warning! Before assembly, make sure that the tool is switched off and unplugged

Fitting the side handle and depth stop (fig. A, B)

- Turn the grip counter clockwise until you can slide the side handle (7) onto the front of the tool as shown (fig. A).
- Rotate the side handle into the desired position.
- Insert the depth stop (6) into the mounding hole as shown (Fig.B)
- Set the drilling depth as described below.
- Tighten the side handle by turning the grip clockwise.

Fitting a drill bit (Fig.C)

- Open the chuck by turning the sleeve (5) counter clockwise.
- Insert the bit shaft (9) into the chuck (drill bit not included)
- Insert the chuck key (10) into each hole (8) in the side of the chuck and turn clockwise until it is tight.

Removing and refitting the chuck (Fig.D)

- Open the chuck as far as possible.

- Remove the chuck retaining screw, located in the chuck, by turning it clockwise using a screwdriver.
- Tighten an Allen key. Remove the chuck by turning it counter clockwise.
- To refit the chuck, screw it onto the spindle and secure it with the chuck retaining screw.

Residual risks

Additional residual risks may arise when using the tool which may not be included in the enclosed safety warnings. These risks can arise from misuse, prolonged use etc.

Even with the application of the relevant safety regulations and the implementation of safety devices, certain residual risks cannot be avoided. These include:

- Injuries caused by touching any rotating/moving parts.
- Injuries caused when changing any parts, blades or accessories.
- Injuries caused by prolonged use of a tool. When using any tool for prolonged periods make sure you take regular breaks.
- Impairment of hearing.
- Health hazards caused by breathing dust developed when using your tool (example:- working with wood, especially oak, beech and MDF).

USE



Warning! Let the tool work at its own pace. Do not overload.



Warning! Before drilling into walls, floors or ceilings, check for the location of wiring and pipes.

Selecting the direction of rotation (fig.E)

For drilling and for tightening screws, use forward (clockwise) rotation. For loosening screws or removing a jammed drill bit, use reverse (counter clockwise) rotation.

- To select forward rotation, push the forward/ reverse button (3) to the left position.
- To select reverse rotation, push the forward /reverse button to the right. **Warning!** Never change the direction of rotation while the motor is running.

Selecting the drilling mode

- For drilling in masonry, set the drilling mode selector (4) to the **T** position.
- For drilling in other materials and for screwdriving, set the drilling mode selector to the **2** position.

Setting the drilling depth (fig.B)

- Slacken the side handle (7) by turning the grip counter clockwise.
- Set the depth stop (6) to the desired position. The maximum drilling depth is equal to the distance between the tip of the drill bit and the front end of the depth stop.
- Tighten the side handle by turning the grip clockwise.

Switching on and off

- To switch the tool on, press the variable speed switch(1). The tool speed depends on how far you press the switch. As a general rule, use low speeds for large diameter drill bits and high speeds for smaller diameter drill bits.
- For continuous operation, press the lock-on button (2) and release the variable speed switch. This option is available only at full speed in both forward and reverse modes.
- To switch the tool off, release the variable speed switch. To switch the tool off when in continuous operation, press the variable speed switch again and release it.

Maintenance

Your STANLEY power tool has been designed to operate over a long period of time with a minimum of maintenance. Continuous satisfactory operation depends upon proper tool care and regular cleaning.

Important

To ensure product SAFETY and RELIABILITY, repairs, maintenance and adjustment (other than those listed in this manual) should be performed by authorized service centers or other qualified organizations, always –using identical replacement parts inside.

Cleaning



Warning! Blow dirt and dust out the main housing with dry air as often as dirt is seen collecting in and around the air vents. Wear approved eye protection and approved dust mask when performing this procedure.



Warning! Never use solvents or other harsh chemicals for cleaning the non – metallic parts of the tool. These chemicals may weaken the materials used in these parts. Use a cloth dampened only with water and mild soap. Never let any liquid get inside the tool; never immerse any part of the tool into a liquid.

Accessories



The performance of any power tool is dependent upon the accessory used. STANLEY accessories are engineered to high quality standards and are designed to enhance the performance of power tool.

STANLEY offers a large selection of accessories available at our local dealer or authorized service center at extra cost.

Caution: The use of any other accessory not recommended for use with this tool could be hazardous.

Service Information

STANLEY offers a full network of company-owned and authorized service locations throughout Europe. All STANLEY Service Centers are staffed with trained personnel to provide customers with efficient and reliable power tool service. Whether you need technical advice, repair , or genuine factory replacement parts, contact the STANLEY location nearest to you.

Notes

- STANLEY's policy is one of continuous improvement to our products and, as such , we reserve the right to change product specifications without prior notice.
- Standard equipment and accessories may vary by country.
- Product specifications may differ by country.
- Complete product range may not be available in all countries. Contact your local STANLEY dealers for range availability.

Protecting the environment



Separate collection. This product must not be disposed of with normal household waste.

Should you find one day that your STANLEY product needs replacement, or if it is of no further use to you, do not dispose of it with household waste. Make this product available for separate collection.



Separate collection of used products and packaging allows materials to be recycled and used again.

Re-use of recycled materials helps prevent environmental pollution and reduces the demand for raw materials.

Local regulations may provide for separate collection of electrical products from the household, at municipal waste sites or by the retailer when you purchase a new product. STANLEY provides a facility for the collection and recycling of STANLEY products once they have reached the end of their working life. To take advantage of this service please return your product to any authorised repair agent who will collect them on our behalf.

You can check the location of your nearest authorised repair agent by contacting your local STANLEY office at the address indicated in this manual. Alternatively, a list of authorised STANLEY repair agents and full details of our after-sales service and contacts are available on the Internet at: www.2helpU.com

One year warranty

If your STANLEY product becomes defective due to faulty materials or workmanship within 12 months from the date of purchase, STANLEY guarantees to replace all defective parts free of charge or – at our discretion – replace the unit free of charge provided that:

- The product has not been misused and has been used in accordance with the instruction manual.
- The product has been subject to fair wear and tear;
- Repairs have not been attempted by unauthorised persons;
- Proof of purchase is produced.
- The STANLEY product is returned complete with all original components

If you wish to make a claim, contact your seller or check the location of your nearest authorised STANLEY repair agent in the STANLEY catalogue or contact your local STANLEY office at the address indicated in this manual. A list of authorised STANLEY repair agents and full details of our after sales service is available on the internet at: www.stanleytools.com

Names & Addresses for STANLEY Service Concessionaries - MIDDLE EAST & AFRICA

ALGERIA: Sarl Outillage Corporation, 08 Rue Med Boudiaf - Cheraga - Algiers, Algeria. Tel: (213-21) 375130, Fax: (213-21) 369667. **ANGOLA:** Angoferraria, Lda., Rua Robert Shields, No. 61, Luanda, Angola. Tel: 00244-222-395837 / 222-395034, Fax: 00244-222-394790. **AZERBAIJAN:** Royalton Holdings Ltd. 41 Khagani St. Apt. 47 AZ 1001, Baku. Tel: (994-12) 4935544, Fax: (994-12) 5980378. **BAHRAIN:** Kavalani & Sons W.L.L., P.O. Box 71, Sitra, Manama, Tel: (973) 17732888, Fax: (973) 17737379. Alfouz Services Co. W.L.L., P.O. Box 26562, Tubli, Manama. Tel: (973) 17783562, Fax: (973) 17783479. **Egypt:** El Farab S.A.E., 15-Nabil El Wakkad Street, Dokki, Giza, Egypt. Tel: 00202-37603946 / 002-010-2582544, Fax: 00202-33352796. **ETHIOPIA:** Seif Tewfik Sherif, Arada Sub-City, Kebele 01/02, Global Insurance Building, 2nd Floor, Room 43, P.O. Box 2525, Addis Ababa, Ethiopia. Tel: (251-11) 1563968/ 1563969, Fax: (251-11) 1558009. **IRAQ:** Financial Links, Kazzaz Building Ararat Al-Hindia Block No: 629 Street: 31 Building No: 1 Baghdad - Iraq. Tel: 00964 (0)780 195 2223/ 00964 (0)781 3763044. Al Sard Co. for General Trading Ltd. Jbara Bldg. 3Flr, Al Rasheed St. Bagdad. Tel: (964) 18184102. Sakhar Group, Arrasat al-hindya Al Masbah, Baghdad. (964) 7400144446. **JORDAN:** Palestine Bldg. Matl. (Bashiti Hardware), 93 King Abdullah 2nd Street. Opp. ELBA House, P.O. Box 3005, Amman 11953, Tel: (962-6) 5349098, Fax: (962-6) 5330731. **KENYA:** Dextron Tools Ltd., P.O. Box 20121-00200, Shariff House, Kimathi Street, Nairobi. Tel: (254-20) 6905000/ 2358021, Fax: (254-20) 6905111/ 6905112. **KUWAIT:** Al Omar Technical Co., P.O. Box 4062, 13041 Safat, Kuwait. Tel: (965) 24848595/ 24840039, Fax: (965) 24845652. Fawaz Al Zayani Establishment, P.O. Box 42426, Shop No. 18, Al Humaizi Commercial Complex, Khalifa Al Jassim, Shuwaikh, Kuwait. Tel: (965) 24828710, Fax: (965) 24828716. Fawaz Al Zayani Establishment, P.O. Box 42426, Shop No.18, Al Humaizi Commercial Complex, Khalifa Al Jassim, Shuwaikh, Kuwait. Tel: (965) 24828710, Fax: (965) 24828716. Fawaz Al Zayani Establishment, Fahaheel Industrial Area, Main St., Sanaya, Kuwait. Tel: (965) 23925830, Fax: (965) 24828716. **LEBANON:** Est. Shaya & Azar S.A.R.L., Boulevard Jdeideh - Mar Takla - Bouchrieh. P.O. Box 90545 Jdeideh.Beirut - Lebanon. Tel: 00961 1 872305 / 306 , Fax: 00961 1 872303. **LIBYA:** North Africa Trading (El Ghoul Brothers), AlHilal Service Center Tawergha St. Misurata. Tel: 00218-091-3221408. **(Benghazi)** Sniydal st., Amr Ibn El-Aas Rd. Tel: (+218) 92 5771120. **(Tripoli)** Al Barniq Service Center, Mokhazin elskar st., ElFallah. Tel: (+218) 21 4808019. **(Misrata)** Al Hilal Service Center, Tawergha st. Tel: (+218) 51 2626743. **MAURITIUS:** Robert Le Marie Limited, Old Moka Road, Bell Village, P.O. Box 161, Port Louis, Tel: 00230-212 1865/ 212 2847, Fax: 00230-2080843. **MOROCCO:** Ets Louis Guillaud & Cie, 149, Quartier Industriel, Moulay Rachid, Casablanca, Postal Code 20450, Morocco. Tel: 00212-522729233, Fax: 00212-522729096. **NIGERIA:** Meridian Power Tools Ltd., Gr.Floor, #1 Alhaji Masha Rd, Next to Teslim Balogun Stadium, Near National Stadium Surulere, Lagos, Nigeria. Tel: 00234-1-7740431 / 7740410, Fax: 00234-1-7913798. **OMAN:** Al Jizzi Company LLC, P.O. Box 1704, PC 112 Ruwi, Oman. Tel: (968) 24832618/ 24835153, Fax: (968) 24831334/24836460. Al Hassan Technical & Construction Supplies Co. LLC, P.O. Box 1948, P.C. 112, Ruwi, Tel: (968) 24810575 / 24837054, Fax: (968) 24810287/ 24833080. Oman Hardware Co. LLC, P.O. Box 635, Ruwi Postal Code 112, Tel: (968) 24815131, Fax: (968) 24816491. Khimji Ramdas, P.O. Box 19, Post Code 100, Ghala, Muscat, Oman. Tel: (968) 24595906/ 907, Fax: (968) 24852752. Oman Marketing & Service Co. (Omasco), P.O. Box 2734, Behind Honda Showroom, Wattayah, Oman. Tel: (968) 24560232/ 24560255, Fax: (968) 24560993. Oman Marketing & Service Co. (Omasco), Al Ohi, Sohar, Oman. Tel: (968) 26846379, Fax: (968) 26846379. Oman Marketing & Service Co. (Omasco), Sanaya, Salalah, Oman. Tel: (968) 23212290, Fax: (968) 23210936. **PAKISTAN:** ZIT Co - Nasir & Bros., 2nd Floor, Qadri Center, Chokwal Dargan Railway Road, Lahore, Pakistan. Tel: 0092 42 37670839, Fax: 0092 42 37652989. Ammar Service & Spares, 60-Bank Arcade, Serai Road, Karachi, Pakistan. Tel: (92-21) 32426905, Fax: (92-21) 32427214. **QATAR:** Teyseer Industrial Supplies & Services Co. W.L.L, 55, Al Wakalat St. (Between St. 18 & 19) Salwa Industrial Area, P.O. Box 40523 Doha, Qatar. Tel: (974) 44581536, Fax: (974) 44682024. Shaheen Electrical Works & Trading Co. W.L.L, Gate 34, St. 44 Industrial Area P.O. Box 9756, Doha, Qatar. Tel: (974) 44600230 / 44600525, Fax: (974) 44601338. Al Mufah Service Centre, Al Wakrah Road, P.O. Box 875, Doha, Qatar. Tel: (974) 44650880/ 44650110/ 44446868, Fax: (974) 44441415 / 44662599. **SAUDI ARABIA: (Al Bahr)** Mohamed Ahmed Bin Afif Est., P.O. Box 530, Yanbu, Al Bahr. Tel: (966-4) 3222626/ 3228867, Fax: (966-4) 3222210. **(Al Khobar)** Fawaz Ebrahim Al Zayani Trading Est., P.O. Box 76026, Al Khobar # 31952, Tel: (966-3) 8140914, Fax: (966-3) 8140824. MSS (Al-Mojil Supply & Services) P.O. Box 450, Jubail 31951, Opp. Gulf Bridge Library & Riyadh House. Tel: (966-3) 3612850/ 3624487/ 3621729, Fax: (966-3) 3623589/ 3620783. **(Dammam)** MSS (Al-Mojil Supply & Services), P.O. Box 450, Jubail 31951, Opp. Gulf Bridge Library & Riyadh House. Tel: (966-3) 3612850 / 3624487 / 3621729, Fax: (966-3) 3623589 / 3620783. **(Al Bawardi Tools & Hardware)**, P.O. Box 112, Dammam, Tel: (966-3) 8330780 Ext.24 / 8348585 Ext. 24 / +966-3-8335555, Fax: (966-3) 8336303. **(Al Hassa)** Mutawa Trading & Gen. Services, Maliki road Hafuf city, Al Hassa, KSA. Tel: (966) 502866275 **(Jeddah)** Al Bawardi Tools & Hardware, P.O. Box 16905, Jeddah 21474, Tel: (966-2) 6444547 / 6439035 / 6456095, Fax: (966-2) 6439024. EAC (Al Yousef Contg. & Trdg. Est.), P.O. Box 30377, Jeddah -21477, Tel: (966-2) 6519912, Fax: (966-2) 6511153. **(Madina)** Garziz Trading for Bldg Mat & Decoration, P.O. Box 3364, Madina. Tel: (966-4) 826 14 90 / 8227636, Fax: (966-4) 8265741. **(Riyadh)** Industrial Material Organization (IMO), P.O. Box 623, Rial Street, Riyadh, Tel: (966-1) 4028010 Ext 26 / 8001245757, Fax: (966-1) 4037970. Sultan Garment Factory (RSC), P.O. Box 29912, Riyadh 11467, KSA, Tel: (966-1) 4055148 / 4042889, Fax: (966-1) 4055148. Al Bawardi Tools & Hardware, P.O. Box 68, Riyadh 11411, Tel: (966-1) 4484999, Fax: (966-1) 4487877. **(Yanbu)** Fawaz Ebrahim Al Zayani, Opposite to Al Fouzan, Jeddah highway or King Abdul Aziz road, Yanbu. Tel: (966-4) 3960980, Fax: (966-4) 3961980. Mohamed Ahmed Bin Afif Est., P.O. Box 530, Yanbu, Al Bahr, Tel: (966-4) 3222626/ 3228867, Fax: (966-4) 3222210. **SOUTH AFRICA:** Stanley Black & Decker - RSA, 199 Winetree Drive Stormill Exit 9 Rooodepoort. Tel: (2711) 472 0454, Fax: (2711) 472 0482. Trecco Power Tool Service 14 Steenbok Street, Koedoespoort, 0186, Pretoria, South Africa. Tel: (27-86) 1873826, Fax: (27-86) 5001771. **TANZANIA:** General Motors investment Ltd., P.O. Box 16541, 14 Nyerere Road, Vingunguti, Dar-es-Salaam. Tel: (255 22) 2862661/ 2865022, Fax: (255 22) 2862667. **TUNISIA:** Societe Tunisienne De Maintenance (STM), Rue de la Physique. Nouvelle Zone Industrielle Ben Arous., 2013 Ben Arous, Tunisia. Tel: (+216) 79 389687, Fax: (+216) 71 385154. **UAE: (Abu Dhabi)** Light House Electrical, P.O. Box 120, Abu Dhabi. Tel: (971-2) 6726131, Fax: (971-2) 6720667. Galaxy Equipment Trading, Madinat Zayed (Baada Zaid), Abu Dhabi P.C. 58910, Tel: (971-2) 8844279, Fax: (971-2) 8844297 **(Ajman)** Al Sukoon Gen. Trdg. Co. LLC, P.O. Box 2975, Ajman. Tel: (971-6) 7435725/ 7438317, Fax: (971-6) 7437350, Al Sukoon Gen. Trdg. Co. LLC, P.O. Box 2975, Ajman, Tel: (971-6) 7435725 / 7438317, Fax: (971-6) 7437350 **(Al Ain)** Zillion Equipment and Spare Parts Trading LLC, P.O. Box 19740, Opp. Bin Sada/ Trimix Redymy Sanaiya, Al Ain. Tel: (971-3) 7216690, Fax: (971-3) 7216103. **(Dubai)** Black & Decker (Overseas) GmbH, P.O. Box 5420, Dubai. Tel: (971-4) 8127400/ 8127406, Fax: (971-4)2822765. Ideal Star Workshop Eqp't.Trading LLC, P.O. Box 37116, Al Quoz, Dubai. Tel: (971-4) 3474160, Fax: (971-4) 3474157, Fine Tools, P.O.Box 30139, Al Quoz, Dubai, Tel: (971-4) 3385240, Fax: (971-4) 3385239, Albrech Engineering Service, P.O. Box 78954, Al Qusais, Dubai. Tel: (971-4) 2850044, Fax: (971-4) 2848402. **(Musafah)** Light House Electrical, P.O. Box 120, Abu Dhabi. Tel: (971-2) 5548315, Fax: (971-2) 5540461. **(Sharjah)** Mc Coy Middle East LLC, P.O. Box 25793, Sharjah. Tel: (971-6) 5395931, Fax: (971-6) 5395932. Burj Al Madeena, Industrial Area No.1, Opp. Pakistani Masjid, P.O. Box 37635, Sharjah. Tel: (971-6) 5337747, Fax: (971-6) 5337719. Burj Al Madeena, Industrial Area No.1 opp Pakistani Masjid P.O. Box 37635, Sharjah. Tel: (971-6) 5337747, Fax: (971-6) 5337719 **(Ras Al Khaimah)** Mc Coy Middle East LLC, P.O. Box 10584, Ras Al Khaimah. Tel: (971-7) 2277095, Fax: (971-7) 2277096. **UGANDA:** The Building Center (U) Ltd., 52 Station Road, Kitgum House, P.O. Box 7436, Kampala, Uganda. Tel: (256-41) 4234567/ 4259754, Fax: (256-41) 4236413. **YEMEN: (Aden)** Middle East Trad. Co. Ltd. (METCO), Mualla Dakka, Aden, Yemen. Tel: (967-2) 222670, Fax: (967-2) 222670. **(Sana'a)** Middle East Trad. Co. Ltd. (METCO), Hayel St., Sana'a, Yemen. Tel: (967-1) 204201, Fax: (967-1) 204204. **(Taiz)** Middle East Trading Co. (METCO), P.O. Box 12363, 5th Flr, Hayel Saeed Anam Bldg, Al-Mugammah St. Taiz, Yemen. Tel: (967-4) 213455, Fax: (967-4) 219869.