

# SIDCHROME®

## SCMT90001

Operation and Maintenance  
Manual

1/2" SCMT90001



### **WARNING**

To reduce the risk of injury, read and understand these safety warnings and instructions before using the tool. Keep these instructions with the tool for future reference. If you have any questions, contact your **SIDCHROME** representative or distributor.



## 18V CORDLESS IMPACT WRENCH









## **WARNING**



### Definitions: Safety Guidelines

The definitions below describe the level of severity for each signal word. Please read the manual and pay attention to these symbols.

-  **DANGER:** Indicates an imminently hazardous situation which, if not avoided, **will result in death or serious injury.**
-  **WARNING:** Indicates a potentially hazardous situation which, if not avoided, **could result in death or serious injury.**
-  **CAUTION:** Indicates a potentially hazardous situation which, if not avoided, **may result in minor or moderate injury.**
-  **NOTICE:** Indicates a practice **not related to personal injury** which, if not avoided, **may result in property damage.**
-  Denotes risk of electric shock
-  Denotes risk of fire
-  **WARNING:** To reduce the risk of injury, read the instruction manual.

## General Power Tool Safety Warnings

-  **WARNING! Read all safety warnings and all instructions.** Failure to follow the warnings and instructions may result in electric shock, fire and/or serious injury.

### SAVE ALL WARNINGS AND INSTRUCTIONS FOR FUTURE REFERENCE

The term "power tool" in the warnings refers to your mains-operated (corded) power tool or battery-operated (cordless) power tool.

#### 1) Work area safety

- a) **Keep work area clean and well lit.** Cluttered or dark areas invite accidents.
- b) **Do not operate power tools in explosive atmospheres, such as in the presence of flammable liquids, gases or dust.** Power tools create sparks which may ignite the dust or fumes.
- c) **Keep children and bystanders away while operating a power tool.** Distractions can cause you to lose control.

#### 2) Electrical safety

- a) **Power tool plugs must match the outlet. Never modify the plug in any way. Do not use any adapter plugs with earthed (grounded) power tools.** Unmodified plugs and matching outlets will reduce risk of electric shock.
- b) **Avoid body contact with earthed or grounded surfaces such as pipes, radiators, ranges and refrigerators.** There is an increased risk of electric shock if your body is earthed or grounded.
- c) **Do not expose power tools to rain or wet conditions.** Water entering a power tool will increase the risk of electric shock.
- d) **Do not abuse the cord. Never use the cord for carrying, pulling or unplugging the power tool. Keep cord away from heat, oil, sharp edges or moving parts.** Damaged or entangled cords increase the risk of electric shock.
- e) **When operating a power tool outdoors, use an extension cord suitable for outdoor use.** Use of a cord suitable for outdoor use reduces the risk of electric shock.
- f) **If operating a power tool in a damp location is unavoidable, use a residual current device (RCD) protected supply.** Use of an RCD reduces the risk of electric shock.

#### 3) Personal safety

- a) **Stay alert, watch what you are doing and use common sense when operating a power tool. Do not use a power tool while you are tired or under the influence of drugs, alcohol or medication.** A moment of inattention while operating power tools may result in serious personal injury.
- b) **Use personal protective equipment. Always wear eye protection.** Protective equipment such as dust mask, non-skid safety shoes, hard hat, or hearing protection used for appropriate conditions will reduce personal injuries.
- c) **Prevent unintentional starting. Ensure the switch is in the off position before connecting to power source**





**and/or battery pack, picking up or carrying the tool.** Carrying power tools with your finger on the switch or energizing power tools that have the switch on invites accidents.

- d) **Remove any adjusting key or wrench before turning the power tool on.** A wrench or a key left attached to a rotating part of the power tool may result in personal injury.
- e) **Do not overreach. Keep proper footing and balance at all times.** This enables better control of the power tool in unexpected situations.
- f) **Dress properly. Do not wear loose clothing or jewelry. Keep your hair, clothing and gloves away from moving parts.** Loose clothes, jewelry or long hair can be caught in moving parts.
- g) **If devices are provided for the connection of dust extraction and collection facilities, ensure these are connected and properly used.** Use of dust collection can reduce dust-related hazards.

#### 4) Power tool use and care

- a) **Do not force the power tool. Use the correct power tool for your application.** The correct power tool will do the job better and safer at the rate for which it was designed.
- b) **Do not use the power tool if the switch does not turn it on and off.** Any power tool that cannot be controlled with the switch is dangerous and must be repaired.
- c) **Disconnect the plug from the power source and/or the battery pack from the power tool before making any adjustments, changing accessories, or storing power tools.** Such preventive safety measures reduce the risk of starting the power tool accidentally.
- d) **Store idle power tools out of the reach of children and do not allow persons unfamiliar with the power tool or these instructions to operate the power tool.** Power tools are dangerous in the hands of untrained users.
- e) **Maintain power tools. Check for misalignment or binding of moving parts, breakage of parts and any other condition that may affect the power tool's operation. If damaged, have the power tool repaired before use.** Many accidents are caused by poorly maintained power tools.
- f) **Keep cutting tools sharp and clean.** Properly maintained cutting tools with sharp cutting edges are less likely to bind and are easier to control.
- g) **Use the power tool, accessories and tool bits, etc. in accordance with these instructions, taking into account the working conditions and the work to be performed.** Use of the power tool for operations different from those intended could result in a hazardous situation.

#### 5) Battery tool use and care

- a) **Recharge only with the charger specified by the manufacturer.** A charger that is suitable for one type of battery pack may create a risk of fire when used with another battery pack.
- b) **Use power tools only with specifically designated battery packs.** Use of any other battery packs may create a risk of injury and fire.
- c) **When battery pack is not in use, keep it away from other metal objects like paper clips, coins, keys, nails, screws, or other small metal objects that can make a connection from one terminal to another.** Shorting the battery terminals together may cause burns or a fire.
- d) **Under abusive conditions, liquid may be ejected from the battery; avoid contact. If contact accidentally occurs, flush with water. If liquid contacts eyes, additionally seek medical help.** Liquid ejected from the battery may cause irritation or burns.

#### 6) Service

- a) **Have your power tool serviced by a qualified repair person using only identical replacement parts.** This will ensure that the safety of the power tool is maintained.

### Additional Specific Safety Rules

- **Hold power tool by insulated gripping surfaces when performing an operation where the fastener may contact hidden wiring.** Fasteners contacting a "live" wire may make exposed metal parts of the power tool "live" and could give the operator an electric shock.
- **Use clamps or other practical way to secure and support the workpiece to a stable platform.** Holding the work by hand or against your body is unstable and may lead to loss of control.
- **Wear safety goggles or other eye protection.** Hammering and drilling operations cause chips to fly. Flying particles can cause permanent eye damage.





- **Bits, sockets and tools get hot during operation.** Wear gloves when touching them.
- **Air vents often cover moving parts and should be avoided.** Loose clothes, jewelry or long hair can be caught in moving parts.

### Residual Risks

In spite of the application of the relevant safety regulations and the implementation of safety devices, certain residual risks cannot be avoided. These are :

- Impairment of hearing.
- Risk of personal injury due to flying particles;
- Risk of burns due to accessories becoming hot during operation.
- Risk of personal injury due to prolonged use.

**⚠️ WARNING: ALWAYS** use safety glasses. Everyday eyeglasses are NOT safety glasses. Also use face or dust mask if cutting operation is dusty. **ALWAYS WEAR CERTIFIED SAFETY EQUIPMENT.**

**⚠️ WARNING:** Some dust created by power sanding, sawing, grinding, drilling, and other construction activities contains chemicals known to cause cancer, birth defects or other reproductive harm. Some examples of these chemicals are:

- lead from lead-based paints,
- crystalline silica from bricks and cement and other masonry products, and
- arsenic and chromium from chemically-treated lumber (CCA).

Your risk from these exposures varies, depending on how often you do this type of work. To reduce your exposure to these chemicals: work in a well ventilated area, and work with approved safety equipment, such as those dust masks that are specially designed to filter out microscopic particles.

- **Avoid prolonged contact with dust from power sanding, sawing, grinding, drilling, and other construction activities. Wear protective clothing and wash exposed areas with soap and water.** Allowing dust to get into your mouth, eyes, or lay on the skin may promote absorption of harmful chemicals.

**⚠️ CAUTION:** When not in use, place tool on its side on a stable surface where it will not cause a tripping or falling hazard. Some tools with large battery packs will stand upright on the battery pack but may be easily knocked over.

- The label on your tool may include the following symbols. The symbols and their definitions are as follows:

V	volts	W	watts
Hz	hertz		alternating current
min	minutes		alternating or direct current
	direct current	no	no load speed
	Class I Construction (grounded)		earthing terminal
	Class II Construction (double insulated)		safety alert symbol
.../min	per minute	RPM	revolutions per minute
IPM	impacts per minute	BPM	beats per minute
A	amperes		

## Important Safety Instructions for All Battery Packs

When ordering replacement battery packs, be sure to include catalog number and voltage. The battery pack is not fully charged out of the carton. Before using the battery pack and charger, read the safety instructions below. Then follow charging procedures outlined.

### READ ALL INSTRUCTIONS

- **Do not charge or use the battery pack in explosive atmospheres, such as in the presence of flammable liquids, gases or dust.** Inserting or removing the battery pack from the charger may ignite the dust or fumes.
- **NEVER force the battery pack into charger. DO NOT modify battery pack in any way to fit into a non-compatible charger as battery pack may rupture causing serious personal injury.**





- Charge the battery packs only in SIDCHROME chargers.
- **DO NOT** splash or immerse in water or other liquids.
- **Do not store or use the tool and battery pack in locations where the temperature may reach or exceed 40 °C (105 °F) (such as outside sheds or metal buildings in summer).**
- For best results, make sure the battery pack is fully charged before use.

**NOTE:** Do not store the battery packs in a tool with the trigger switch locked on. Never tape the trigger switch in the ON position.

**⚠ WARNING:** Fire hazard. Never attempt to open the battery pack for any reason. If battery pack case is cracked or damaged, do not insert into charger. Do not crush, drop or damage battery pack. Do not use a battery pack or charger that has received a sharp blow, been dropped, run over or damaged in any way (i.e., pierced with a nail, hit with a hammer, stepped on). Damaged battery packs should be returned to service center for recycling.

**⚠ WARNING:** Fire hazard. **Do not store or carry battery so that metal objects can contact exposed battery terminals.** For example, do not place battery in aprons, pockets, tool boxes, product kit boxes, drawers, etc., with loose nails, screws, keys, etc. **Transporting batteries can possibly cause fires if the battery terminals inadvertently come in contact with conductive materials such as keys, coins, hand tools and the like.**

**⚠ CAUTION:** When not in use, place tool on its side on a stable surface where it will not cause a tripping or falling hazard. Some tools with large battery packs will stand upright on the battery pack but may be easily knocked over.

#### **Specific safety instructions for lithium ion (li-ion)**

- **Do not incinerate the battery pack even if it is severely damaged or is completely worn out.** The battery pack can explode in a fire. Toxic fumes and materials are created when lithium ion battery packs are burned.
- **If battery contents come into contact with the skin, immediately wash area with mild soap and water.** If battery liquid gets into the eye, rinse water over the open eye for 15 minutes or until irritation ceases. If medical attention is needed, the battery electrolyte is composed of a mixture of liquid organic carbonates and lithium salts.
- **Contents of opened battery cells may cause respiratory irritation.** Provide fresh air. If symptoms persists, seek medical attention.

**⚠ WARNING:** Burn hazard. Battery liquid may be flammable if exposed to spark or flame.

## **Important Safety Instructions for All Battery Chargers**

**SAVE THESE INSTRUCTIONS:** This manual contains important safety and operating instructions for battery chargers.

- Before using charger, read all instructions and cautionary markings on charger, battery pack, and product using battery pack.

**⚠ WARNING:** Shock hazard. Do not allow any liquid to get inside charger. Electric shock may result.

**⚠ CAUTION:** Burn hazard. To reduce the risk of injury, charge only SIDCHROME rechargeable batteries. Other types of batteries may burst causing personal injury and damage.

**⚠ CAUTION:** Children should be supervised to ensure that they do not play with the appliance.

**NOTICE:** Under certain conditions, with the charger plugged in to the power supply, the charger can be shorted by foreign material. Foreign materials of a conductive nature such as, but not limited to, grinding dust, metal chips, steel wool, aluminum foil, or any buildup of metallic particles should be kept away from charger cavities. Always unplug the charger from the power supply when there is no battery pack in the cavity. Unplug charger before attempting to clean.

- **DO NOT attempt to charge the battery pack with any chargers other than the ones in this manual.** The charger and battery pack are specifically designed to work together.
- **These chargers are not intended for any uses other than charging SIDCHROME rechargeable batteries.** Any other uses may result in risk of fire, electric shock or electrocution.
- **Do not expose charger to rain or snow.**
- **Pull by plug rather than cord when disconnecting charger.** This will reduce risk of damage to electric plug and cord.
- **Make sure that cord is located so that it will not be stepped on, tripped over, or otherwise subjected to damage or stress.**
- **Do not use an extension cord unless it is absolutely necessary.** Use of improper extension cord could result in risk of fire, electric shock, or electrocution.
- **When operating a power tool outdoors, use an extension cord suitable for outdoor use.** Use of a cord suitable for outdoor use reduces the risk of electric shock.
- **Do not block the ventilation slots on the charger. The ventilation slots are located on the top and sides of the charger.** Place the charger in a position away from any heat source.





- **Do not operate charger with damaged cord or plug** - have them replaced immediately.
- **Do not operate charger if it has received a sharp blow, been dropped, or otherwise damaged in any way.** Take it to an authorized service center.
- **Do not disassemble charger; take it to an authorized service center when service or repair is required.** Incorrect reassembly may result in a risk of electric shock, electrocution or fire.
- In case of damaged power supply cord the supply cord must be replaced immediately by the manufacturer, its service agent or similar qualified person to prevent any hazard.
- **Disconnect the charger from the outlet before attempting any cleaning.** This will reduce the risk of electric shock. Removing the battery pack will not reduce this risk.
- **NEVER** attempt to connect 2 chargers together.
- **The charger is designed to operate on standard 230V household electrical power. Do not attempt to use it on any other voltage.** This does not apply to the vehicular charger.

## SAVE THESE INSTRUCTIONS

### Chargers

This charger requires no adjustment and is designed to be as easy as possible to operate.

#### Charging Procedure (Fig.1)

1. Plug the charger into an appropriate outlet before inserting battery pack.
2. Insert the battery pack (D) into the charger, as shown in Figure 1, making sure the pack is fully seated in charger. The red (charging) light will blink continuously indicating that the charging process has started.
3. The completion of charge will be indicated by the red light remaining ON continuously. The pack is fully charged and may be used at this time or left in the charger.

**NOTE :** To ensure maximum performance and life of Li-Ion batteries, fully charge the pack before first use.



#### Indicator Light Operation

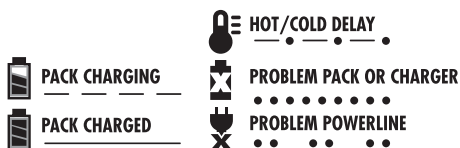

#### Charge Indicators

Some chargers are designed to detect certain problems that can arise with battery packs. Problems are indicated by the red light flashing at a fast rate. If this occurs, re-insert battery pack into the charger. If the problem persists, try a different battery pack to determine if the charger is OK. If the new pack charges correctly, then the original pack is defective and should be returned to a service center or other collection site for recycling. If the new battery pack elicits the same trouble indication as the original, have the charger tested at an authorized service center.





## Hot/Cold pack delay

Some chargers have a Hot/Cold Pack Delay feature: when the charger detects a battery that is hot, it automatically starts a Hot Pack Delay, suspending charging until the battery has cooled. After the battery has cooled, the charger automatically switches to the Pack Charging mode. This feature ensures maximum battery life. The red light flashes long, then short while in the Hot/Cold Pack Delay mode.

## Leaving the battery pack in the charger

The charger and battery pack can be left connected with the charge indicator showing «Pack Charged».

**Weak battery packs:** Weak batteries will continue to function but should not be expected to perform as much work.

**Faulty battery packs:** This charger will not charge a faulty battery pack. The charger will indicate faulty battery pack by refusing to light or by displaying problem pack or charger.

**Note:** This could also mean a problem with a charger.

## Problem Power Line

Some chargers have a «Problem Powerline indicator». When the charger is used with some portable power sources such as generators or sources that convert DC to AC, the charger may temporarily suspend operation, **flashing the red light with two fast blinks followed by a pause**. This indicates the power source is out of limits.

## Important Charging Notes

1. Longest life and best performance can be obtained if the battery pack is charged when the air temperature is between 18–24 °C (65 °F and 75 °F). DO NOT charge the battery pack in an air temperature below +4.5 °C (+40 °F), or above +40.5 °C (+105 °F). This is important and will prevent serious damage to the battery pack.
2. The charger and battery pack may become warm to touch while charging. This is a normal condition, and does not indicate a problem. To facilitate the cooling of the battery pack after use, avoid placing the charger or battery pack in a warm environment such as in a metal shed, or an uninsulated trailer.
3. If the battery pack does not charge properly:
  - a. Check operation of receptacle by plugging in a lamp or other appliance;
  - b. Check to see if receptacle is connected to a light switch which turns power off when you turn out the lights;
  - c. Move charger and battery pack to a location where the surrounding air temperature is approximately 18–24 °C (65 °F–75 °F);
  - d. If charging problems persist, take the tool, battery pack and charger to your local service center.
4. The battery pack should be recharged when it fails to produce sufficient power on jobs which were easily done previously. DO NOT CONTINUE to use under these conditions. Follow the charging procedure. You may also charge a partially used pack whenever you desire with no adverse affect on the battery pack.
5. Foreign materials of a conductive nature such as, but not limited to, grinding dust, metal chips, steel wool, aluminum foil, or any buildup of metallic particles should be kept away from charger cavities. Always unplug the charger from the power supply when there is no battery pack in the cavity. Unplug charger before attempting to clean.
6. Do not freeze or immerse charger in water or any other liquid.

**⚠ WARNING:** Shock hazard. Don't allow any liquid to get inside charger. Electric shock may result.

**⚠ WARNING:** Never attempt to open the battery pack for any reason. If the plastic housing of the battery pack breaks or cracks, return to a service center for recycling.

## Additional Important Safety Instructions for all Battery Packs

### Battery type

The SCMT90001 operates on an 18 volt battery pack.

The SCMT90051 AND SCMT90052 battery packs may be used. Refer to technical data for more information.

### Storage Recommendations

1. The best storage place is one that is cool and dry away from direct sunlight and excess heat or cold. For optimum battery performance and life, store battery packs at room temperature when not in use.
2. For long storage, it is recommended to store a fully charged battery pack in a cool dry place out of the charger for optimal results.

**NOTE:** Battery packs should not be stored completely depleted of charge. The battery pack will need to be recharged before use.





## Labels on Charger and Battery Pack



Read instruction manual before use



Battery charging



Battery charged



HOT/COLD pack delay



Problem pack or charger



Problem powerline



Do not probe with conductive objects



Do not charge damaged battery packs



Use only with Sidchrome battery packs. other may burst causing personal injury and damage.



Do not expose to water.



Have defective cords replaced immediately.



Charger only between 4°C and 40°C.



Discard the battery pack with due care for the environment.



Do not incinerate the battery pack.



Charges li-ion battery packs.



See technical data for charging time.



Only for indoor use.

## SAVE THESE INSTRUCTIONS FOR FUTURE USE

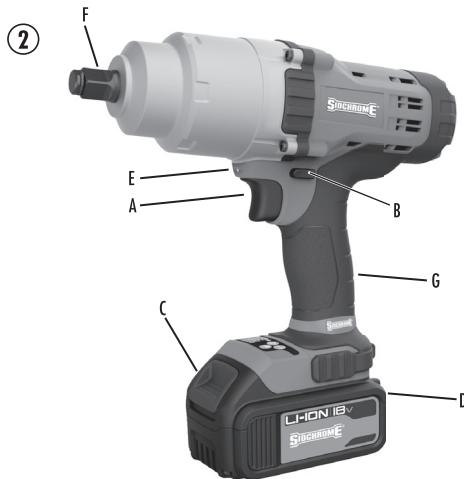

### Description (Fig. 2)

**⚠ WARNING:** Never modify the power tool or any part of it. Damage or personal injury could result.

- |    |                        |    |             |
|----|------------------------|----|-------------|
| A. | Trigger switch         | E. | Worklight   |
| B. | Forward/reverse button | F. | Anvil       |
| C. | Battery release button | G. | Main handle |
| D. | Battery pack           |    |             |





## Intended use

These impact wrenches are designed for professional impact applications. The impact function makes this tool particularly useful for metal fasteners.

**DO NOT** use under wet conditions or in presence of flammable liquids or gases. These heavy-duty impact wrenches are professional power tools.

**DO NOT** let children come into contact with the tool. Supervision is required when inexperienced operators use this tool.

This product is not intended for use by persons (including children) suffering from diminished physical, sensory or mental abilities, or for lack of experience and/or for want of knowledge or skills unless they are supervised by a person responsible for their safety. Children should never be left alone to play with this product.

## Electrical safety

The electric motor has been designed for one voltage only. Always check that the battery pack voltage corresponds to the voltage on the rating plate. Also make sure that the voltage of your charger corresponds to that of your mains.

Your SIDCHROME charger is double insulated in accordance with EN 60335; therefore no earth is required.

If the supply cord is damaged, it must be replaced by a specially prepared cord available through the SIDCHROME service organization.

## Using an extension cable

An extension cord should not be used unless absolutely necessary. Use an approved extension cable suitable for the power input of your charger. The minimum conductor size is 1 mm<sup>2</sup>; the maximum length is 30m.

When using a cable reel, always unwind the cable completely.

## Operation

**⚠ WARNING:** Always observe the safety instructions and applicable regulations.

**⚠ WARNING:** To reduce the risk of serious personal injury, place the forward/reverse button in the lock-off position or turn tool off and disconnect battery pack before making any adjustments or removing/installing attachments or accessories. An accidental start-up can cause injury.

**⚠ WARNING:** Use only SIDCHROME battery pack and chargers.

## Installing and Removing the Battery Pack (Fig. 3)

**NOTE:** Make sure your battery pack is fully charged.

To install the battery pack (D) into the tool handle, align the battery pack with the rails inside the tool's handle and slide it into the handle until the battery pack is firmly seated in the tool and ensure that it does not engage.

To remove the battery pack from the tool, press the release button (C) and firmly pull the battery pack out of the tool handle. Insert it into the charger as described in the charger section of this manual.

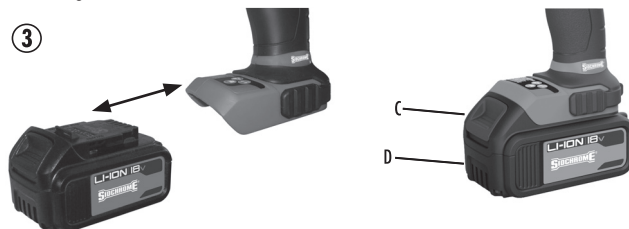

## Variable Speed Trigger Switch (Fig. 2)

To turn the tool on, squeeze the trigger switch (A). To turn the tool off, release the trigger switch. Your tool is equipped with a brake. The anvil will stop when the trigger switch is fully released. The variable speed switch enables you to select the best speed for a particular application. The more you squeeze the trigger, the faster the tool will operate. For maximum tool life, use variable speed only for starting holes or fasteners.

**NOTE:** Continuous use in variable speed range is not recommended. It may damage the switch and should be avoided.





## Forward/Reverse Control Button (Fig. 2)

A forward/reverse control button (B) determines the direction of the tool and also serves as a lock off button. To select forward rotation, release the trigger switch and depress the forward/reverse control button on the right side of the tool. To select reverse, depress the forward/reverse control button on the left side of the tool. The center position of the control button locks the tool in the OFF position. When changing the position of the control button, be sure the trigger is released.

**NOTE:** The first time the tool is run after changing the direction of rotation, you may hear a click on start up. This is normal and does not indicate a problem.

## Proper Hand Position (Fig.2,4)

**WARNING:** To reduce the risk of serious personal injury, **ALWAYS** use proper hand position as shown.

**WARNING:** To reduce the risk of serious personal injury, **ALWAYS** hold securely in anticipation of a sudden reaction.

Proper hand position requires one hand on the main handle (G).



## Worklight (Fig. 2,5)

There is a worklight (E) located above the trigger switch (A). The worklight is activated when the trigger switch is depressed, and will automatically turn off 20 seconds after the trigger switch is pulled. If the trigger switch remains depressed, the worklight will remain on.

**NOTE:** The worklight is for lighting the immediate work surface and is not intended to be used as a flashlight.



## Anvil with Hog Ring (Fig. 2, 6)

**WARNING:** Use only impact sockets. Non-impact sockets may break and cause a hazardous condition. Inspect socket prior to use to ensure that it contains no cracks.

Place the forward/reverse button (B) in the locked off (center) position or remove battery pack before changing accessories.

To install a socket on the hog ring anvil, firmly push socket onto the anvil (F). The hog ring (K) compresses to allow the socket to slide on. After the socket is installed, the hog ring applies pressure to help provide socket retention.

To remove a socket, grasp the socket and firmly pull it off.

**CAUTION:** Inspect anvils and hog rings prior to use. Missing or damaged items should be replaced before use.

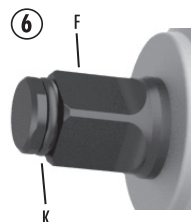

## SPECIFICATIONS

Model	Square drive	Impact rate	Breakaway torque	Noise level						Vibrations level	
				Pressure dB(A)		Power dB(A)		Pressure dB(C)		m/s <sup>2</sup>	
	in	bpm	ft-lbs / N.m		k*		k*		k*		k**
SCMT90001	1/2	2400	725 / 983	92	3	103	3	115	3	11.5	2.3

Model	Free speed	Weight	Dimensions
	rpm	lbs / kg	in
SCMT90001	1800	5.2 / 2.4	9.5 x 3.1 x 8.3

\* k = measurement uncertainty in dB \*\* k = measurement uncertainty in m/s





**⚠ CAUTION:** Ensure fastener and/or system will withstand the level of torque generated by the tool. Excessive torque may cause breakage and possible personal injury.

1. Place the socket on the fastener head. Keep the tool pointed straight at the fastener.
2. Press switch to start operation. Always check torque with a torque wrench, as the fastening torque is affected by many factors including the following:
  - **Voltage:** Low voltage, due to a nearly discharged battery, will reduce fastening torque.
  - **Socket size:** Failure to use the correct socket size will cause a reduction in fastening torque.
  - **Bolt size:** Larger bolt diameters generally require higher fastening torque. Fastening torque will also vary according to length, grade, and torque coefficient.
  - **Bolt:** Ensure that all threads are free of rust and other debris to allow proper fastening torque.
  - **Material:** The type of material and surface finish of the material will affect fastening torque.
  - **Fastening Time:** Longer fastening time results in increased fastening torque. Using a longer fastening time than recommended could cause the fasteners to be overstressed, stripped or damaged.

## Maintenance

Your SIDCHROME power tool has been designed to operate over a long period of time with a minimum of maintenance. Continuous satisfactory operation depends upon proper tool care and regular cleaning.

**⚠ WARNING:** To reduce the risk of serious personal injury, place the forward/reverse button in the lock-off position or turn tool off and disconnect battery pack before making any adjustments or removing/installing attachments or accessories.

## Lubrication

Your power tool requires no additional lubrication.

## Cleaning

**⚠ WARNING:** Never use solvents or other harsh chemicals for cleaning the non-metallic parts of the tool. These chemicals may weaken the plastic materials used in these parts. Use a cloth dampened only with water and mild soap. Never let any liquid get inside the tool; never immerse any part of the tool into a liquid.

## Charger cleaning instructions

**⚠ WARNING:** Shock hazard. Disconnect the charger from the AC outlet before cleaning. Dirt and grease may be removed from the exterior of the charger using a cloth or soft non-metallic brush. Do not use water or any cleaning solutions.

## Accessories

**⚠ WARNING:** Since accessories, other than those offered by SIDCHROME, have not been tested with this product, use of such accessories with this tool could be hazardous. To reduce the risk of injury, only SIDCHROME-recommended accessories should be used with this product. Consult your dealer for further information on the appropriate accessories.

**⚠ WARNING:** Use only impact accessories. Non-impact accessories may break and cause a hazardous condition. Inspect accessories prior to use to ensure that it contains no cracks.

## Repairs

The charger and battery pack are not serviceable. There are no serviceable parts inside the charger or battery pack.

To assure product SAFETY and RELIABILITY, repairs, maintenance and adjustment (including brush inspection and replacement) should be performed by a SIDCHROME authorized service center or other qualified service personnel. Always use identical replacement parts.

## Protecting the environment

### DISPOSAL OF THIS ARTICLE

Dear Customer, If you at some point intend to dispose of this article, then please keep in mind that many of its components consist of valuable materials, which can be recycled.

Please do not discharge it in the garbage bin, but check with your local council for recycling facilities in your area.





Separate collection of used product and packaging allows materials to be recycled and used again.  
Re-use of recycled materials helps prevent environmental pollution and reduces the demand for raw materials.

### **Rechargeable Battery Pack**



This long life battery pack must be recharged when it fails to produce sufficient power on jobs which were easily done before.  
At the end of its technical life, discard it with due care for our environment:

- Run the Battery pack down completely, then remove it from the tool.
- Li-Ion cells are recyclable. Take them to your dealer or a local recycling station. The collected battery packs will be recycled or disposed of properly.

## **After-sales service**

- For any question or intervention in the machine, call your SIDCHROME distributor.





# SIDCHROME®

SCMT90051



SCMT90052



SCMT90061





# SIDCHROME<sup>®</sup>



SIDCHROME  
82 TARYN DRIVE  
EPPING VICTORIA 3076  
AUSTRALIA

Customer Service Phone Number  
1 800 338 002

Copyright © 2014 SIDCHROME

Manual #30L200124