

---

**DEWALT**®

---

***XR LI-ION***

**[www.DEWALT.com](http://www.DEWALT.com)**

**DCG409**

---

|  |    |
|--|----|
| English ( <i>original instructions</i> ) | 4  |
| 简体中文                                     | 20 |
| 繁體中文                                     | 33 |
| 한국어                                      | 45 |
| ภาษาไทย                                  | 59 |
| TIẾNG VIỆT                               | 78 |

---

Fig. A  
图A  
圖A  
그림A  
꺆A  
Hình A

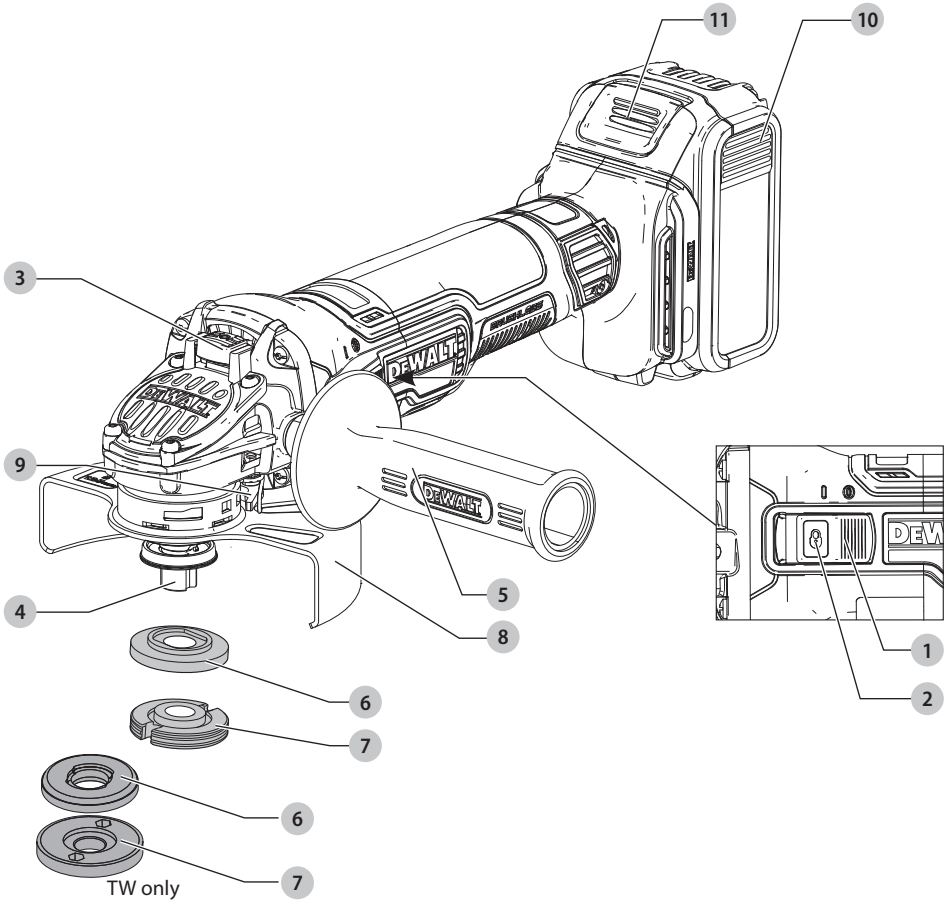

Fig. B  
图B  
圖B  
그림B  
꺆B  
Hình B

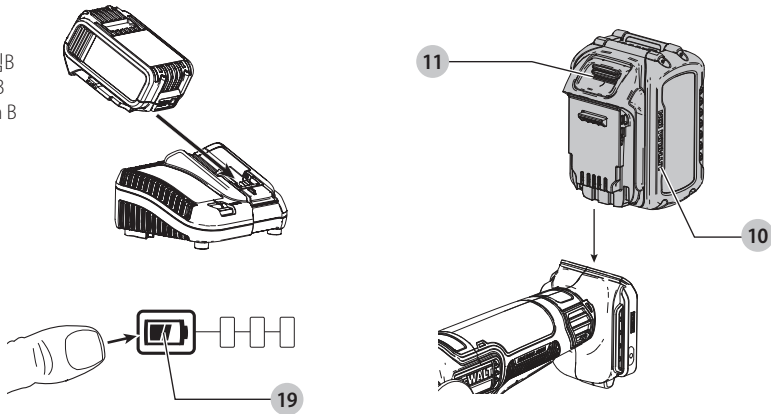

Fig. C  
图C  
圖C  
그림C  
꺠 C  
Hinh C

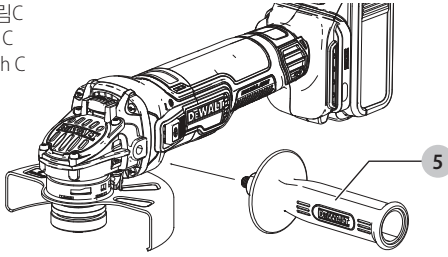

Fig. D  
图D  
圖D  
그림D  
꺠 D  
Hinh D

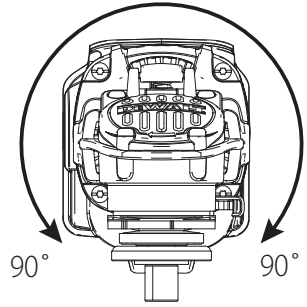

Fig. E  
图E  
圖E  
그림E  
꺠 E  
Hinh E

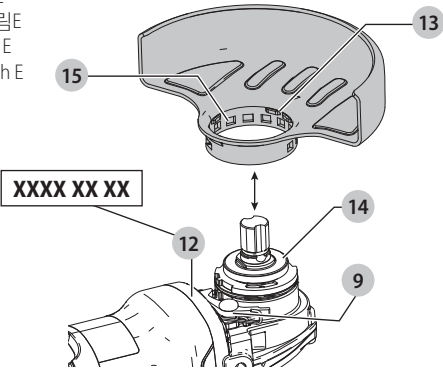

Fig. F  
图F  
圖F  
그림F  
꺠 F  
Hinh F

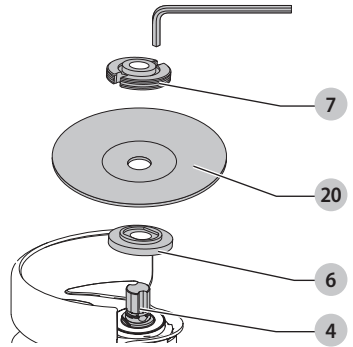

Fig. G  
图G  
圖G  
그림G  
꺠 G  
Hinh G

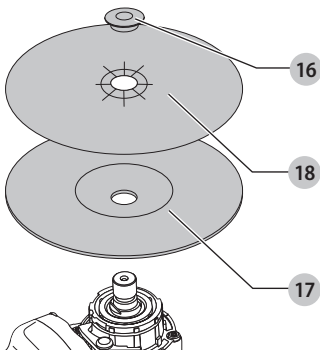

Fig. H  
图H  
圖H  
그림H  
꺠 H  
Hinh H

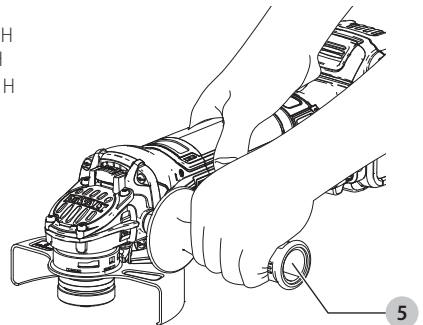
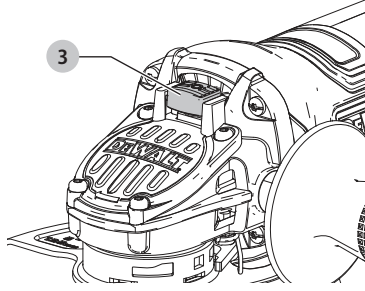

Fig. 1  
图 1  
圖 1  
그림 1  
รูป 1  
Hinh 1



# SLIDE SWITCH GRINDER

## DCG409

### Congratulations!

You have chosen a DEWALT tool. Years of experience, thorough product development and innovation make DEWALT one of the most reliable partners for professional power tool users.

### Technical Data

|                               |                   | DCG409-TW   | DCG409-B1   | DCG409-KR   | DCG409NT-A9 |
|-------------------------------|-------------------|-------------|-------------|-------------|-------------|
| Voltage                       | V <sub>DC</sub>   | 18 (20 Max) | 18 (20 Max) | 18 (20 Max) | 18 (20 Max) |
| Battery type                  |                   | Li-Ion      | Li-Ion      | Li-Ion      | Li-Ion      |
| Max. Power Output             | W                 | 1647        | 1647        | 1647        | 1647        |
| Rated speed                   | min <sup>-1</sup> | 9000        | 9000        | 9000        | 9000        |
| Wheel diameter                | mm                | 125         | 100         | 125         | 125         |
| Wheel thickness (max)         | mm                | 6           | 4           | 6           | 6           |
| Spindle diameter              |                   | M14         | M10         | M10         | M14         |
| Spindle length                | mm                | 21.5        | 16          | 16          | 21.5        |
| Weight (without battery pack) | kg                | 1.81        | 1.62        | 1.73        | 1.81        |

The vibration and/or noise emission level given in this information sheet has been measured in accordance with a standardised test given in EN60745 and may be used to compare one tool with another. It may be used for a preliminary assessment of exposure.

 **WARNING:** The declared vibration and/or noise emission level represents the main applications of the tool. However if the tool is used for different applications, with different accessories or poorly maintained, the vibration and/or noise emission may differ. This may significantly increase the exposure level over the total working period.

An estimation of the level of exposure to vibration and/or noise should also take into account the times when the tool

is switched off or when it is running but not actually doing the job. This may significantly reduce the exposure level over the total working period.

Identify additional safety measures to protect the operator from the effects of vibration and/or noise such as: maintain the tool and the accessories, keep the hands warm (relevant for vibration), organisation of work patterns.



**WARNING:** To reduce the risk of injury, read the instruction manual.

### Definitions: Safety Guidelines

The definitions below describe the level of severity for each signal word. Please read the manual and pay attention to these symbols.



**DANGER:** Indicates an imminently hazardous situation which, if not avoided, **will** result in **death or serious injury**.



**WARNING:** Indicates a potentially hazardous situation which, if not avoided, **could** result in **death or serious injury**.



**CAUTION:** Indicates a potentially hazardous situation which, if not avoided, **may** result in **minor or moderate injury**.

**NOTICE:** Indicates a practice **not related to personal injury** which, if not avoided, **may** result in **property damage**.



Denotes risk of electric shock.



Denotes risk of fire.

| Batteries     |                   |          |            | Chargers / Charge Times (Minutes) |        |        |        |         |         |        |         |
|---------------|-------------------|----------|------------|-----------------------------------|--------|--------|--------|---------|---------|--------|---------|
| Cat#          | V <sub>DC</sub>   | Ah       | Weight(kg) | DCB104                            | DCB107 | DCB112 | DCB115 | DCB117  | DCB118  | DCB132 | DCB1112 |
| DCB546/DCB606 | 18/54 (20/60 Max) | 6.0/2.0  | 1.05       | 60                                | 270    | 170    | 90     | 40      | 60      | 90     | 40      |
| DCB547/DCB609 | 18/54 (20/60 Max) | 9.0/3.0  | 1.46       | 75*                               | 420    | 270    | 135*   | 60      | 75*     | 135*   | 60      |
| DCB548/DCB612 | 18/54 (20/60 Max) | 12.0/4.0 | 1.44       | 120                               | 540    | 350    | 180    | 80      | 120     | 180    | 80      |
| DCB181        | 18 (20 Max)       | 1.5      | 0.35       | 22                                | 70     | 45     | 22     | 22      | 22      | 22     | 22      |
| DCB182/DCB204 | 18 (20 Max)       | 4.0      | 0.61       | 60/40**                           | 185    | 120    | 60     | 60/40** | 60/40** | 60     | 60/40** |
| DCB183/DCB203 | 18 (20 Max)       | 2.0      | 0.40       | 30                                | 90     | 60     | 30     | 30      | 30      | 30     | 30      |
| DCB184/DCB205 | 18 (20 Max)       | 5.0      | 0.62       | 75/50**                           | 240    | 150    | 75     | 75/50** | 75/50** | 75     | 75/50** |
| DCB185        | 18 (20 Max)       | 1.3      | 0.35       | 22                                | 60     | 40     | 22     | 22      | 22      | 22     | 22      |
| DCB187        | 18 (20 Max)       | 3.0      | 0.54       | 45                                | 140    | 90     | 45     | 45      | 45      | 45     | 45      |
| DCB189/DCB240 | 18 (20 Max)       | 4.0      | 0.54       | 60                                | 185    | 120    | 60     | 60      | 60      | 60     | 60      |
| DCB186        | 18 (20 Max)       | 6.0      | 0.95       | 60                                | 270    | 170    | 90     | 60      | 60      | 90     | 60      |

\*Date code 201811475B or later

\*\*Date code 201536 or later

## GENERAL POWER TOOL SAFETY WARNINGS



**WARNING:** Read all safety warnings, instructions, illustrations and specifications provided with this power tool. Failure to follow all instructions listed below may result in electric shock, fire and/or serious injury.

### SAVE ALL WARNINGS AND INSTRUCTIONS FOR FUTURE REFERENCE

The term "power tool" in the warnings refers to your mains-operated (corded) power tool or battery-operated (cordless) power tool.

#### 1) Work Area Safety

- Keep work area clean and well lit.** Cluttered or dark areas invite accidents.
- Do not operate power tools in explosive atmospheres, such as in the presence of flammable liquids, gases or dust.** Power tools create sparks which may ignite the dust or fumes.
- Keep children and bystanders away while operating a power tool.** Distractions can cause you to lose control.

#### 2) Electrical Safety

- Power tool plugs must match the outlet. Never modify the plug in any way. Do not use any adapter plugs with earthed (grounded) power tools.** Unmodified plugs and matching outlets will reduce risk of electric shock.
- Avoid body contact with earthed or grounded surfaces, such as pipes, radiators, ranges and refrigerators.** There is an increased risk of electric shock if your body is earthed or grounded.
- Do not expose power tools to rain or wet conditions.** Water entering a power tool will increase the risk of electric shock.
- Do not abuse the cord. Never use the cord for carrying, pulling or unplugging the power tool. Keep cord away from heat, oil, sharp edges or moving parts.** Damaged or entangled cords increase the risk of electric shock.
- When operating a power tool outdoors, use an extension cord suitable for outdoor use.** Use of a cord suitable for outdoor use reduces the risk of electric shock.
- If operating a power tool in a damp location is unavoidable, use a residual current device (RCD) protected supply.** Use of an RCD reduces the risk of electric shock.

#### 3) Personal Safety

- Stay alert, watch what you are doing and use common sense when operating a power tool. Do not use a power tool while you are tired or under the influence of drugs, alcohol or medication.** A moment of inattention while operating power tools may result in serious personal injury.
- Use personal protective equipment. Always wear eye protection.** Protective equipment such as a dust mask, non-skid safety shoes, hard hat or hearing protection used for appropriate conditions will reduce personal injuries.

- Prevent unintentional starting. Ensure the switch is in the off-position before connecting to power source and/or battery pack, picking up or carrying the tool.** Carrying power tools with your finger on the switch or energising power tools that have the switch on invites accidents.
- Remove any adjusting key or wrench before turning the power tool on.** A wrench or a key left attached to a rotating part of the power tool may result in personal injury.
- Do not overreach. Keep proper footing and balance at all times.** This enables better control of the power tool in unexpected situations.
- Dress properly. Do not wear loose clothing or jewellery. Keep your hair and clothing away from moving parts.** Loose clothes, jewellery or long hair can be caught in moving parts.
- If devices are provided for the connection of dust extraction and collection facilities, ensure these are connected and properly used.** Use of dust collection can reduce dust-related hazards.
- Do not let familiarity gained from frequent use of tools allow you to become complacent and ignore tool safety principles.** A careless action can cause severe injury within a fraction of a second.

#### 4) Power Tool Use and Care

- Do not force the power tool. Use the correct power tool for your application.** The correct power tool will do the job better and safer at the rate for which it was designed.
- Do not use the power tool if the switch does not turn it on and off.** Any power tool that cannot be controlled with the switch is dangerous and must be repaired.
- Disconnect the plug from the power source and/or remove the battery pack, if detachable, from the power tool before making any adjustments, changing accessories, or storing power tools.** Such preventive safety measures reduce the risk of starting the power tool accidentally.
- Store idle power tools out of the reach of children and do not allow persons unfamiliar with the power tool or these instructions to operate the power tool.** Power tools are dangerous in the hands of untrained users.
- Maintain power tools and accessories. Check for misalignment or binding of moving parts, breakage of parts and any other condition that may affect the power tool's operation. If damaged, have the power tool repaired before use.** Many accidents are caused by poorly maintained power tools.
- Keep cutting tools sharp and clean.** Properly maintained cutting tools with sharp cutting edges are less likely to bind and are easier to control.
- Use the power tool, accessories and tool bits etc. in accordance with these instructions, taking into account the working conditions and the work to be performed.** Use of the power tool for operations different from those intended could result in a hazardous situation.

- h) **Keep handles and grasping surfaces dry, clean and free from oil and grease.** Slippery handles and grasping surfaces do not allow for safe handling and control of the tool in unexpected situations.

## 5) Battery Tool Use and Care

- a) **Recharge only with the charger specified by the manufacturer.** A charger that is suitable for one type of battery pack may create a risk of fire when used with another battery pack.
- b) **Use power tools only with specifically designated battery packs.** Use of any other battery packs may create a risk of injury and fire.
- c) **When battery pack is not in use, keep it away from other metal objects, like paper clips, coins, keys, nails, screws or other small metal objects, that can make a connection from one terminal to another.** Shorting the battery terminals together may cause burns or a fire.
- d) **Under abusive conditions, liquid may be ejected from the battery; avoid contact. If contact accidentally occurs, flush with water. If liquid contacts eyes, additionally seek medical help.** Liquid ejected from the battery may cause irritation or burns.
- e) **Do not use a battery pack or tool that is damaged or modified.** Damaged or modified batteries may exhibit unpredictable behaviour resulting in fire, explosion or risk of injury.
- f) **Do not expose a battery pack or tool to fire or excessive temperature.** Exposure to fire or temperature above 130 °C may cause explosion.
- g) **Follow all charging instructions and do not charge the battery pack or tool outside the temperature range specified in the instructions.** Charging improperly or at temperatures outside the specified range may damage the battery and increase the risk of fire.

## 6) Service

- a) **Have your power tool serviced by a qualified repair person using only identical replacement parts.** This will ensure that the safety of the power tool is maintained.
- b) **Never service damaged battery packs.** Service of battery packs should only be performed by the manufacturer or authorized service providers.

## ADDITIONAL SPECIFIC SAFETY RULES

### Safety Instructions for All Operations

- a) **This power tool is intended to function as a grinder, sander, wire brush or cut-off tool. Read all safety warnings, instructions, illustrations and specifications provided with this power tool.** Failure to follow all instructions listed below may result in electric shock, fire and/or serious injury.
- b) **Operations such as polishing are not recommended to be performed with this power tool.** Operations for which the power tool was not designed may create a hazard and cause personal injury.

- c) **Do not use accessories which are not specifically designed and recommended by the tool manufacturer.** Just because the accessory can be attached to your power tool, it does not assure safe operation.
- d) **The rated speed of the accessory must be at least equal to the maximum speed marked on the power tool.** Accessories running faster than their rated speed can break and fly apart.
- e) **The outside diameter and the thickness of your accessory must be within the capacity rating of your power tool.** Incorrectly sized accessories can not be adequately guarded or controlled.
- f) **Threaded mounting of accessories must match the grinder spindle thread. For accessories mounted by flanges, the arbour hole of the accessory must fit the locating diameter of the flange.** Accessories that do not match the mounting hardware of the power tool will run out of balance, vibrate excessively and may cause loss of control.
- g) **Do not use a damaged accessory. Before each use inspect the accessory such as abrasive wheel for chips and cracks, backing pad for cracks, tear or excess wear, wire brush for loose or cracked wires. If power tool or accessory is dropped, inspect for damage or install an undamaged accessory. After inspecting and installing an accessory, position yourself and bystanders away from the plane of the rotating accessory and run the power tool at maximum no-load speed for one minute.** Damaged accessories will normally break apart during this test time.
- h) **Wear personal protective equipment. Depending on application, use face shield, safety goggles or safety glasses. As appropriate, wear dust mask, hearing protectors, gloves and workshop apron capable of stopping small abrasive or workpiece fragments.** The eye protection must be capable of stopping flying debris generated by various operations. The dust mask or respirator must be capable of filtering particles generated by your operation. Prolonged exposure to high intensity noise may cause hearing loss.
- i) **Keep bystanders a safe distance away from work area. Anyone entering the work area must wear personal protective equipment.** Fragments of workpiece or of a broken accessory may fly away and cause injury beyond immediate area of operation.
- j) **Hold the power tool by insulated gripping surfaces only, when performing an operation where the cutting tool may contact hidden wiring.** Contact with a "live" wire will also make exposed metal parts of the power tool "live" and could give the operator an electric shock.
- k) **Never lay the power tool down until the accessory has come to a complete stop.** The spinning accessory may grab the surface and pull the power tool out of your control.



- l) **Do not run the power tool while carrying it at your side.** Accidental contact with the spinning accessory could snag your clothing, pulling the accessory into your body.
- m) **Regularly clean the power tool's air vents.** The motor's fan will draw the dust inside the housing and excessive accumulation of powdered metal may cause electrical hazards.
- n) **Do not operate the power tool near flammable materials.** Sparks could ignite these materials.
- o) **Do not use accessories that require liquid coolants.** Using water or other liquid coolants may result in electrocution or shock.
- p) **Do not use Type 11 (flaring cup) wheels on this tool.** Using inappropriate accessories can result in injury.
- q) **Always use side handle. Tighten the handle securely.** The side handle should always be used to maintain control of the tool at all times.



**WARNING:** We recommend the use of a residual current device with a residual current rating of 30mA or less.

## FURTHER SAFETY INSTRUCTIONS FOR ALL OPERATIONS

### Causes and Operator Prevention of Kickback

Kickback is a sudden reaction to a pinched or snagged rotating wheel, backing pad, brush or any other accessory. Pinching or snagging causes rapid stalling of the rotating accessory which in turn causes the uncontrolled power tool to be forced in the direction opposite of the accessory's rotation at the point of the binding.

For example, if an abrasive wheel is snagged or pinched by the workpiece, the edge of the wheel that is entering into the pinch point can dig into the surface of the material causing the wheel to climb out or kick out. The wheel may either jump toward or away from the operator, depending on direction of the wheel's movement at the point of pinching. Abrasive wheels may also break under these conditions.

Kickback is the result of power tool misuse and/or incorrect operating procedures or conditions and can be avoided by taking proper precautions as given **BELOW:**

- a) **Maintain a firm grip on the power tool and position your body and arm to allow you to resist kickback forces. Always use auxiliary handle, if provided, for maximum control over kickback or torque reaction during start-up.** The operator can control torque reaction or kickback forces, if proper precautions are taken.
- b) **Never place your hand near the rotating accessory.** Accessory may kickback over your hand.
- c) **Do not position your body in the area where power tool will move if kickback occurs.** Kickback will propel the tool in direction opposite to the wheel's movement at the point of snagging.
- d) **Use special care when working corners, sharp edges etc. Avoid bouncing and snagging the accessory.** Corners, sharp edges or bouncing have a tendency to snag the rotating accessory and cause loss of control or kickback.
- e) **Do not attach a saw chain woodcarving blade or toothed saw blade.** Such blades create frequent kickback and loss of control.

### Safety Warnings Specific for Grinding and Abrasive Cutting-Off Operations

- a) **Use only wheel types that are recommended for your power tool and the specific guard designed for the selected wheel.** Wheels for which the power tool was not designed cannot be adequately guarded and are unsafe.
- b) **The grinding surface of centre depressed wheels must be mounted below the plane of the guard lip.** An improperly mounted wheel that projects through the plane of the guard lip cannot be adequately protected.
- c) **The guard must be securely attached to the power tool and positioned for maximum safety, so the least amount of wheel is exposed towards the operator.** The guard helps to protect the operator from broken wheel fragments and accidental contact with wheel and sparks that could ignite clothing.
- d) **Wheels must be used only for recommended applications. For example: do not grind with the side of cut-off wheel.** Abrasive cut-off wheels are intended for peripheral grinding, side forces applied to these wheels may cause them to shatter.
- e) **Always use undamaged wheel flanges that are of correct size and shape for your selected wheel. Proper wheel flanges support the wheel thus reducing the possibility of wheel breakage.** Flanges for cut-off wheels may be different from grinding wheel flanges.
- f) **Do not use worn down wheels from larger power tools.** Wheel intended for larger power tool is not suitable for the higher speed of a smaller tool and may burst.

### Additional Safety Warnings Specific for Abrasive Cutting-Off Operations

- a) **Do not "jam" the cut-off wheel or apply excessive pressure. Do not attempt to make an excessive depth of cut.** Overstressing the wheel increases the loading and susceptibility to twisting or binding of the wheel in the cut and the possibility of kickback or wheel breakage.
- b) **Do not position your body in line with and behind the rotating wheel.** When the wheel, at the point of operations, is moving away from your body, the possible kickback may propel the spinning wheel and the power tool directly at you.
- c) **When wheel is binding or when interrupting a cut for any reason, switch off the power tool and hold the power tool motionless until the wheel comes to a complete stop. Never attempt to remove the cut-off**

wheel from the cut while the wheel is in motion otherwise kickback may occur. Investigate and take corrective action to eliminate the cause of wheel binding.

- d) **Do not restart the cutting operation in the workpiece. Let the wheel reach full speed and carefully re-enter the cut.** The wheel may bind, walk up or kickback if the power tool is restarted in the workpiece.
- e) **Support panels or any oversized workpiece to minimise the risk of wheel pinching and kickback. Large workpieces tend to sag under their own weight.** Supports must be placed under the workpiece near the line of cut and near the edge of the workpiece on both sides of the wheel.
- f) **Use extra caution when making a "pocket cut" into existing walls or other blind areas.** The protruding wheel may cut gas or water pipes, electrical wiring or objects that can cause kickback.

## Safety Warnings Specific for Sanding Operations

- a) **Do not use excessively oversized sanding disc paper. Follow manufacturer's recommendations, when selecting sanding paper.** Larger sanding paper extending beyond the sanding pad presents a laceration hazard and may cause snagging, tearing of the disc or kickback.

## Safety Warnings Specific for Wire Brushing Operations

- a) **Be aware that wire bristles are thrown by the brush even during ordinary operation. Do not overstress the wires by applying excessive load to the brush.** The wire bristles can easily penetrate light clothing and/or skin.
- b) **If the use of a guard is recommended for wire brushing, do not allow any interference of the wire wheel or brush with the guard.** Wire wheel or brush may expand in diameter due to work and centrifugal forces.

## Residual Risks

In spite of the application of the relevant safety regulations and the implementation of safety devices, certain residual risks cannot be avoided. These are:

- Impairment of hearing.
- Risk of personal injury due to flying particles.
- Risk of burns due to accessories becoming hot during operation.
- Risk of personal injury due to prolonged use.
- Risk of dust from hazardous substances.

## Chargers

DEWALT chargers require no adjustment and are designed to be as easy as possible to operate.

## Electrical Safety

The electric motor has been designed for one voltage only. Always check that the battery pack voltage corresponds to the voltage on the rating plate. Also make sure that the voltage of your charger corresponds to that of your mains.



Your DEWALT charger is double insulated in accordance with IEC60335; therefore no earth wire is required.

If the supply cord is damaged, it must be replaced only by DEWALT or an authorised service organisation.

## Using an Extension Cable

An extension cord should not be used unless absolutely necessary. Use an approved extension cable suitable for the power input of your charger (see **Technical Data**). The minimum conductor size is 1 mm<sup>2</sup>; the maximum length is 30 m.

When using a cable reel, always unwind the cable completely.

## Important Safety Instructions for All Battery Chargers

**SAVE THESE INSTRUCTIONS:** This manual contains important safety and operating instructions for compatible battery chargers (refer to **Technical Data**).

- Before using charger, read all instructions and cautionary markings on charger, battery pack, and product using battery pack.



**WARNING:** Shock hazard. Do not allow any liquid to get inside charger. Electric shock may result.



**WARNING:** We recommend the use of a residual current device with a residual current rating of 30mA or less.



**CAUTION:** Burn hazard. To reduce the risk of injury, charge only DEWALT rechargeable batteries. Other types of batteries may burst causing personal injury and damage.



**CAUTION:** Children should be supervised to ensure that they do not play with the appliance.

**NOTICE:** Under certain conditions, with the charger plugged into the power supply, the exposed charging contacts inside the charger can be shorted by foreign material. Foreign materials of a conductive nature such as, but not limited to, steel wool, aluminum foil or any buildup of metallic particles should be kept away from charger cavities. Always unplug the charger from the power supply when there is no battery pack in the cavity. Unplug charger before attempting to clean.

- **DO NOT attempt to charge the battery pack with any chargers other than the ones in this manual.** The charger and battery pack are specifically designed to work together.
- **These chargers are not intended for any uses other than charging DEWALT rechargeable batteries.** Any other uses may result in risk of fire, electric shock or electrocution.
- **Do not expose charger to rain or snow.**
- **Pull by plug rather than cord when disconnecting charger.** This will reduce risk of damage to electric plug and cord.

- **Make sure that cord is located so that it will not be stepped on, tripped over, or otherwise subjected to damage or stress.**
- **Do not use an extension cord unless it is absolutely necessary.** Use of improper extension cord could result in risk of fire, electric shock, or electrocution.
- **Do not place any object on top of charger or place the charger on a soft surface that might block the ventilation slots and result in excessive internal heat.** Place the charger in a position away from any heat source. The charger is ventilated through slots in the top and the bottom of the housing.
- **Do not operate charger with damaged cord or plug—** have them replaced immediately.
- **Do not operate charger if it has received a sharp blow, been dropped, or otherwise damaged in any way.** Take it to an authorised service centre.
- **Do not disassemble charger; take it to an authorised service centre when service or repair is required.** Incorrect reassembly may result in a risk of electric shock, electrocution or fire.
- *In case of damaged power supply cord, the supply cord must be replaced immediately by the manufacturer, its service agent or similar qualified person to prevent any hazard.*
- **Disconnect the charger from the outlet before attempting any cleaning. This will reduce the risk of electric shock.** Removing the battery pack will not reduce this risk.
- **NEVER** attempt to connect two chargers together.
- **The charger is designed to operate on standard 220-240V household electrical power. Do not attempt to use it on any other voltage.** This does not apply to the vehicular charger.

## Charging a Battery (Fig. B)

1. Plug the charger into an appropriate outlet before inserting battery pack.
2. Insert the battery pack **10** into the charger, making sure the battery pack is fully seated in the charger. The red (charging) light will blink repeatedly indicating that the charging process has started.
3. The completion of charge will be indicated by the red light remaining ON continuously. The battery pack is fully charged and may be used at this time or left in the charger. To remove the battery pack from the charger, push the battery release button **11** on the battery pack.

**NOTE:** To ensure maximum performance and life of lithium-ion battery packs, charge the battery pack fully before first use.

## Charger Operation

Refer to the indicators below for the charge status of the battery pack.

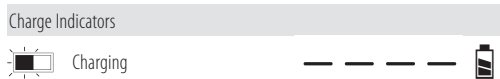

\*The red light will continue to blink, but a yellow indicator light will be illuminated during this operation. Once the battery pack has reached an appropriate temperature, the yellow light will turn off and the charger will resume the charging procedure.

The compatible charger(s) will not charge a faulty battery pack. The charger will indicate faulty battery by refusing to light.

**NOTE:** This could also mean a problem with a charger.

If the charger indicates a problem, take the charger and battery pack to be tested at an authorised service centre.

## Hot/Cold Pack Delay

When the charger detects a battery pack that is too hot or too cold, it automatically starts a Hot/Cold Pack Delay, suspending charging until the battery pack has reached an appropriate temperature. The charger then automatically switches to the pack charging mode. This feature ensures maximum battery pack life.

A cold battery pack will charge at a slower rate than a warm battery pack. The battery pack will charge at that slower rate throughout the entire charging cycle and will not return to maximum charge rate even if the battery pack warms.

The DCB118 charger is equipped with an internal fan designed to cool the battery pack. The fan will turn on automatically when the battery pack needs to be cooled. Never operate the charger if the fan does not operate properly or if ventilation slots are blocked. Do not permit foreign objects to enter the interior of the charger.

## Electronic Protection System

XR Li-Ion tools are designed with an Electronic Protection System that will protect the battery pack against overloading, overheating or deep discharge.

The tool will automatically turn off if the Electronic Protection System engages. If this occurs, place the lithium-ion battery pack on the charger until it is fully charged.

## Wall Mounting

These chargers are designed to be wall mountable or to sit upright on a table or work surface. If wall mounting, locate the charger within reach of an electrical outlet, and away from a corner or other obstructions which may impede air flow. Use the back of the charger as a template for the location of the mounting screws on the wall. Mount the charger securely using drywall screws (purchased separately) at least 25.4 mm long with a screw head diameter of 7–9 mm, screwed into wood to an optimal depth leaving approximately 5.5 mm of the screw exposed. Align the slots on the back of the charger with the exposed screws and fully engage them in the slots.

## Charger Cleaning Instructions

**WARNING: Shock hazard. Disconnect the charger from the AC outlet before cleaning.** Dirt and grease may be removed from the exterior of the charger using a

cloth or soft non-metallic brush. Do not use water or any cleaning solutions. Never let any liquid get inside the tool; never immerse any part of the tool into a liquid.

## Battery Packs

### Important Safety Instructions for All Battery Packs

When ordering replacement battery packs, be sure to include catalogue number and voltage.

The battery pack is not fully charged out of the carton. Before using the battery pack and charger, read the safety instructions below. Then follow charging procedures outlined.

#### READ ALL INSTRUCTIONS

- **Do not charge or use battery in explosive atmospheres, such as in the presence of flammable liquids, gases or dust.** Inserting or removing the battery from the charger may ignite the dust or fumes.
- **Never force battery pack into charger. Do not modify battery pack in any way to fit into a non-compatible charger as battery pack may rupture causing serious personal injury.**
- Charge the battery packs only in DEWALT chargers.
- **DO NOT** splash or immerse in water or other liquids.
- **Do not store or use the tool and battery pack in locations where the temperature may fall below 4 °C (39.2 °F) (such as outside sheds or metal buildings in winter), or reach or exceed 40 °C (104 °F) (such as outside sheds or metal buildings in summer).**
- **Do not incinerate the battery pack even if it is severely damaged or is completely worn out.** The battery pack can explode in a fire. Toxic fumes and materials are created when lithium-ion battery packs are burned.
- **If battery contents come into contact with the skin, immediately wash area with mild soap and water.** If battery liquid gets into the eye, rinse water over the open eye for 15 minutes or until irritation ceases. If medical attention is needed, the battery electrolyte is composed of a mixture of liquid organic carbonates and lithium salts.
- **Contents of opened battery cells may cause respiratory irritation.** Provide fresh air. If symptoms persists, seek medical attention.



**WARNING:** Burn hazard. Battery liquid may be flammable if exposed to spark or flame.



**WARNING:** Never attempt to open the battery pack for any reason. If battery pack case is cracked or damaged, do not insert into charger. Do not crush, drop or damage battery pack. Do not use a battery pack or charger that has received a sharp blow, been dropped, run over or damaged in any way (i.e., pierced with a nail, hit with a hammer, stepped on). Electric shock or electrocution may result. Damaged battery packs should be returned to service centre for recycling.



**WARNING:** Fire hazard. Do not store or carry the battery pack so that metal objects can contact exposed battery terminals. For example, do not place

the battery pack in aprons, pockets, tool boxes, product kit boxes, drawers, etc., with loose nails, screws, keys, etc.



**CAUTION:** When not in use, place tool on its side on a stable surface where it will not cause a tripping or falling hazard. Some tools with large battery packs will stand upright on the battery pack but may be easily knocked over.

### Transportation



**WARNING: Fire hazard.** Transporting batteries can possibly cause fire if the battery terminals inadvertently come in contact with conductive materials. When transporting batteries, make sure that the battery terminals are protected and well insulated from materials that could contact them and cause a short circuit. **NOTE:** Lithium-ion batteries should not be put in checked baggage.

DEWALT batteries comply with all applicable shipping regulations as prescribed by industry and legal standards which include UN Recommendations on the Transport of Dangerous Goods; International Air Transport Association (IATA) Dangerous Goods Regulations, International Maritime Dangerous Goods (IMDG) Regulations, and the European Agreement Concerning The International Carriage of Dangerous Goods by Road (ADR). Lithium-ion cells and batteries have been tested to section 38.3 of the UN Recommendations on the Transport of Dangerous Goods Manual of Tests and Criteria.

In most instances, shipping a DEWALT battery pack will be excepted from being classified as a fully regulated Class 9 Hazardous Material. In general, only shipments containing a lithium-ion battery with an energy rating greater than 100 Watt Hours (Wh) will require being shipped as fully regulated Class 9. All lithium-ion batteries have the Watt Hour rating marked on the pack. Furthermore, due to regulation complexities, DEWALT does not recommend air shipping lithium-ion battery packs alone regardless of Watt Hour rating. Shipments of tools with batteries (combo kits) can be air shipped as excepted if the Watt Hour rating of the battery pack is no greater than 100 Wh. Regardless of whether a shipment is considered excepted or fully regulated, it is the shipper's responsibility to consult the latest regulations for packaging, labeling/marketing and documentation requirements.

The information provided in this section of the manual is provided in good faith and believed to be accurate at the time the document was created. However, no warranty, expressed or implied, is given. It is the buyer's responsibility to ensure that its activities comply with the applicable regulations.

#### Transporting the FLEXVOLT™ Battery

The DEWALT FLEXVOLT™ battery has two modes: **Use** and **Transport**.

**Use Mode:** When the FLEXVOLT™ battery stands alone or is in a DEWALT 18V(20V Max) product, it will operate as an 18V(20V Max) battery. When the FLEXVOLT™ battery is in a 54V(60V Max) or a 108V(120V Max) (two 54V(60V Max) batteries) product, it will operate as a 54V(60V Max) battery.

**Transport Mode:** When the cap is attached to the FLEXVOLT™ battery, the battery is in Transport mode. Keep the cap for shipping.

When in Transport mode, strings of cells are electrically disconnected within the pack resulting in 3 batteries with a lower Watt hour (Wh) rating as compared to 1 battery with a higher Watt hour rating. This increased quantity of 3 batteries with the lower Watt hour rating can exempt the pack from certain shipping regulations that are imposed upon the higher Watt hour batteries.

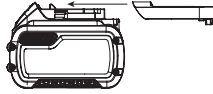

For example, the Transport Wh rating might indicate 3 x 36 Wh, meaning 3 batteries of 36 Wh each. The Use Wh rating might indicate 108 Wh (1 battery implied).

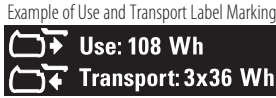

## Storage Recommendations

1. The best storage place is one that is cool and dry away from direct sunlight and excess heat or cold. For optimum battery performance and life, store battery packs at room temperature when not in use.
2. For long storage, it is recommended to store a fully charged battery pack in a cool, dry place out of the charger for optimal results.

**NOTE:** Battery packs should not be stored completely depleted of charge. The battery pack will need to be recharged before use.

## Labels on Charger and Battery Pack

In addition to the pictographs used in this manual, the labels on the charger and the battery pack may show the following pictographs:



Read instruction manual before use.



See **Technical Data** for charging time.



Do not probe with conductive objects.



Do not charge damaged battery packs.



Do not expose to water.



Have defective cords replaced immediately



Charge only between 4 °C and 40 °C.



Only for indoor use.



Discard the battery pack with due care for the environment.



Charge DeWALT battery packs only with designated DeWALT chargers. Charging battery packs other than the designated DeWALT batteries with a DeWALT charger may make them burst or lead to other dangerous situations.



Do not incinerate the battery pack.



USE (without transport cap). Example: Wh rating indicates 108 Wh (1 battery with 108 Wh).



TRANSPORT (with built-in transport cap). Example: Wh rating indicates 3 x 36 Wh (3 batteries of 36 Wh).

## Battery Type

The following tools operate on a 18 (20 Max)volt battery pack: DCG409

These battery packs may be used: DCB181, DCB182, DCB183, DCB183B, DCB184, DCB184B, DCB185, DCB186, DCB187, DCB189, DCB203, DCB204, DCB205, DCB240, DCB546, DCB547, DCB548, DCB606, DCB609, DCB612. Refer to **Technical Data** for more information.

## Package Contents

The package contains:

- 1 Angle grinder
- 1 125 mm Guard (Type 27)
- 1 Side handle
- 1 Flange set
- 1 Hex wrench
- 1 Li-Ion battery pack (C1, D1, L1, M1, P1, S1, T1, X1, Y1 models)
- 2 Li-Ion battery packs (C2, D2, L2, M2, P2, S2, T2, X2, Y2 models)
- 3 Li-Ion battery packs (C3, D3, L3, M3, P3, S3, T3, X3, Y3 models)
- 1 Instruction manual

**NOTE:** Battery packs, chargers and kitboxes are not included with N models. Battery packs and chargers are not included with NT models. B models include Bluetooth® battery packs.

**NOTE:** The Bluetooth® word mark and logos are registered trademarks owned by the Bluetooth®, SIG, Inc. and any use of such marks by DEWALT is under license. Other trademarks and trade names are those of their respective owners.

- Check for damage to the tool, parts or accessories which may have occurred during transport.
- Take the time to thoroughly read and understand this manual prior to operation.

## Markings on Tool

The following pictographs are shown on the tool:



Read instruction manual before use.



Wear ear protection.



Wear eye protection.

## Date Code Position (Fig. E)

The date code **12**, which also includes the year of manufacture, is printed into the housing.

Example:

2021 XX XX

Year and week of Manufacture

## Description (Fig. A)



**WARNING:** Never modify the power tool or any part of it. Damage or personal injury could result.

- 1 Slider switch
- 2 Lock-off lever
- 3 Spindle lock button
- 4 Spindle
- 5 Side handle
- 6 Backing flange
- 7 Locking flange
- 8 Guard
- 9 Guard release lever
- 10 Battery pack
- 11 Battery release button

## Intended Use

The DCG409 cordless angle grinder has been designed for professional cutting, grinding, sanding and wire brush applications.

**DO NOT** use under wet conditions or in the presence of flammable liquids or gases.

This cordless angle grinder is a professional power tool.

**DO NOT** let children come into contact with the tool. Supervision is required when inexperienced operators use this tool.

- **Young children and the infirm.** This appliance is not intended for use by young children or infirm persons without supervision.
- This product is not intended for use by persons (including children) suffering from diminished physical, sensory or mental abilities; lack of experience, knowledge or skills unless they are supervised by a person responsible for their safety. Children should never be left alone with this product.

## Features

### No-Volt switch

The No-volt function stops the grinder restarting without the switch being cycled if there is a break in the power supply.

### Electronic Clutch

This unit is equipped with an E-Clutch™ (Electronic Clutch), which in the event of a high-load or wheel pinch, the unit will be shut off to reduce the reaction torque to the user. The switch needs to be cycled (turned on and off) to restart tool.

### Kickback Brake™

When a pinch, stall, or bind-up event is sensed, the electronic brake engages with maximum force to quickly stop the wheel, reduce the movement of the grinder, and shut the grinder off. The switch will need to be released then depressed to restart tool.

### Power-OFF™ Overload Protection

The power supply to the motor will be reduced in case of motor overload. With continued motor overload, the tool will shut off. The switch will need to be released then depressed to restart tool. The tool will power off each time the current load reaches the overload current value (motor burn-up point). If continued overload shutdowns occur, apply less force/weight on the tool until the tool will function without the overload engaging.

### Soft Start Feature

The soft start feature allows a slow speed build-up to avoid an initial jerk when starting. This feature is particularly useful when working in confined spaces.

### Anti-vibration Side Handle

The anti-vibration side handle offers added comfort by absorbing the vibrations caused by the tool.

## ASSEMBLY AND ADJUSTMENTS



**WARNING:** To reduce the risk of serious personal injury, turn tool off and disconnect battery pack before making any adjustments or removing/installing attachments or accessories. An accidental start-up can cause injury.



**WARNING:** Use only DEWALT battery packs and chargers.

## Inserting and Removing the Battery Pack from the Tool (Fig. B)

**NOTE:** Make sure your battery pack **10** is fully charged.

### To Install the Battery Pack into the Tool Handle

1. Align the battery pack **10** with the rails inside the tool's handle (Fig. B).
2. Slide it into the handle until the battery pack is firmly seated in the tool and ensure that you hear the lock snap into place.

### To Remove the Battery Pack from the Tool

1. Press the release button **11** and firmly pull the battery pack out of the tool handle.
2. Insert battery pack into the charger as described in the charger section of this manual.

### Fuel Gauge Battery Packs (Fig. C)

Some DeWALT battery packs include a fuel gauge which consists of three green LED lights that indicate the level of charge remaining in the battery pack.

To actuate the fuel gauge **19**, press and hold the fuel gauge button. A combination of the three green LED lights will illuminate designating the level of charge left. When the level

of charge in the battery is below the usable limit, the fuel gauge will not illuminate and the battery will need to be recharged.

**NOTE:** The fuel gauge is only an indication of the charge left on the battery pack. It does not indicate tool functionality and is subject to variation based on product components, temperature and end-user application.

## Attaching Side Handle (Fig. C)



**WARNING:** Before using the tool, check that the handle is tightened securely.

Screw the side handle **5** tightly into one of the holes on either side of the gear case. The side handle should always be used to maintain control of the tool at all times.

## Rotating the Gear Case (Fig. D)

To improve user comfort, the gear case will rotate 90° for cutting operations.

1. Remove the four corner screws attaching the gear case to motor housing.
2. Without separating the gear case from motor housing, rotate the gear case head to desired position.

**NOTE:** If the gear case and motor housing become separated by more than 3.17 mm, the tool must be serviced and re-assembled by a DeWALT service center. Failure to have the tool serviced may motor and bearing failure.

3. Reinstall screws to attach the gear case to the motor housing. Tighten screws to 12.5 in.-lbs. torque. Overtightening could cause screws to strip.

## Guards



**CAUTION:** Guards must be used with all grinding wheels, cutting wheels, sanding flap discs, wire brushes, and wire wheels. The tool may be used without a guard only when sanding with conventional sanding discs. Refer to Figure A to see guards provided with the unit. Some applications may require purchasing the correct guard from your local dealer or authorized service centre.

**NOTE:** Edge grinding and cutting can be performed with Type 27 wheels designed and specified for this purpose; 6.35 mm thick wheels are designed for surface grinding while thinner Type 27 wheels need to be examined for the manufacturer's label to see if they can be used for surface grinding or only edge grinding/cutting. A Type 1 guard must be used for any wheel where surface grinding is forbidden. Cutting can also be performed by using a Type 41 wheel and a Type 1 guard.

**NOTE:** See the **Accessory Chart** to select the proper guard / accessory combination.

## Mounting and Adjusting the One-Touch™ Guard (Fig. E)



**WARNING:** To reduce the risk of serious personal injury, turn tool off and disconnect battery pack before making any adjustments or removing/installing attachments or accessories. An accidental start-up can cause injury.

## Adjusting the Guard

For guard adjustment, the guard release lever **9** engages one of the alignment holes **15** on the guard collar using a ratcheting feature.

The engaging face is slanted and will ride over to the next alignment hole when guard is rotated in a clockwise direction (spindle facing user) but self-locks in the anti-clockwise direction.

## Mounting the Guard (Fig. E)

1. Press the guard release lever **9**.
2. While holding the guard release lever open, align the lugs **13** on the guard with the slots **14** on the gear case.
3. Keeping the guard release lever open, push the guard down until the guard lugs engage and rotate them in the groove on the gear case hub. Release the guard release lever.
4. With the spindle facing the operator, rotate the guard clockwise into the desired working position. Press and hold the guard release lever **9** to rotate the guard in the anti-clockwise direction.

**NOTE:** The guard body should be positioned between the spindle and the operator to provide maximum operator protection.

The guard release lever should snap into one of the alignment holes **15** on the guard collar. This ensures that the guard is secure.

5. To remove the guard, follow steps 1–3 of these instructions in reverse.

## Flanges and Wheels

### Mounting Non-Hubbed Wheels (Fig. F)



**WARNING:** Failure to properly seat the flange/ clamp nut/ wheel could result in serious injury (or damage to the tool or wheel).



**CAUTION:** Included flanges must be used with depressed centre Type 27 and Type 42 grinding wheels and Type 41 cutting wheels. See the **Accessory Chart** for more information.



**WARNING:** A closed, two-sided cutting wheel guard is required when using cutting wheels.



**WARNING:** Use of a damaged flange or guard or failure to use proper flange and guard can result in injury due to wheel breakage and wheel contact. See the **Accessory Chart** for more information.

1. Place the tool on a table, guard up.
2. Install the backing flange **6** on spindle **4** with the raised centre (pilot) facing the wheel. Press the backing flange into place.
3. Place wheel **20** against the backing flange, centring the wheel on the raised centre (pilot) of the backing flange.
4. While depressing the spindle lock button and with the hex depressions facing away from the wheel, thread the locking flange **7** on spindle so that the lugs engage the two slots in the spindle.
5. While depressing the spindle lock button, tighten the locking flange **7** by hand or using the wrench supplied.

(Only use a locking flange if it is in perfect condition.) Refer to **Accessory Chart** to see flange details.

6. To remove the wheel, reverse the above procedure.

### Mounting Sanding Backing Pads (Fig. G)

**NOTE:** Use of a guard with sanding discs that use backing pads, often called fiber resin discs, is not required. Since a guard is not required for these accessories, the guard may or may not fit correctly if used.



**WARNING:** Failure to properly seat the flange/ clamp nut/ wheel could result in serious injury (or damage to the tool or wheel).



**WARNING:** Proper guard must be reinstalled for grinding wheel, cutting wheel, sanding flap disc, wire brush or wire wheel applications after sanding applications are complete.

1. Place or appropriately thread backing pad **17** on the spindle.
2. Place the sanding disc **18** on the backing pad **17**.
3. While depressing spindle lock **3**, thread clamp nut **16** on spindle, piloting the raised hub on the clamp nut into the centre of sanding disc and backing pad.
4. Tighten the clamp nut by hand. Then depress the spindle lock button while turning the sanding disc until the sanding disc and clamp nut are snug.
5. To remove the wheel, grasp and turn the backing pad and sanding pad while depressing the spindle lock button.

### Mounting and Removing Hubbed Wheels (Fig. F)

Hubbed wheels install directly on the threaded spindle. Thread of accessory must match thread of spindle.

1. Remove backing flange by pulling away from tool.
2. Thread the wheel on the spindle **4** by hand.
3. Depress the spindle lock button **3** and use a wrench to tighten the hub of the wheel.
4. Reverse the above procedure to remove the wheel.

**NOTICE:** Failure to properly seat the wheel before turning the tool on may result in damage to the tool or the wheel.

### Mounting Wire Cup Brushes and Wire Wheels (Fig. A)



**WARNING:** Failure to properly seat the flange/ clamp nut/ wheel could result in serious injury (or damage to the tool or wheel).



**CAUTION:** To reduce the risk of personal injury, wear work gloves when handling wire brushes and wheels. They can become sharp.



**CAUTION:** To reduce the risk of damage to the tool, wheel or brush must not touch guard when mounted or while in use. Undetectable damage could occur to the accessory, causing wires to fragment from accessory wheel or cup.

Wire cup brushes or wire wheels install directly on the threaded spindle without the use of flanges. Use only wire brushes or wheels provided with a threaded hub. These accessories are

available at extra cost from your local dealer or authorised service centre.

1. Place the tool on a table, guard up.
2. Thread the wheel on the spindle by hand.
3. Depress spindle lock button **3** and use a wrench on the hub of the wire wheel or brush to tighten the wheel.
4. To remove the wheel, reverse the above procedure.

**NOTICE:** To reduce the risk of damage to the tool, properly seat the wheel hub before turning the tool on.

### Prior to Operation

- Install the guard and appropriate disc or wheel. Do not use excessively worn discs or wheels.
- Be sure the backing and locking flange are mounted correctly. Follow the instructions given in the **Accessory Chart**.
- Make sure the disc or wheel rotates in the direction of the arrows on the accessory and the tool.
- Do not use a damaged accessory. Before each use, inspect the accessory such as abrasive wheels for chips and cracks, backing pad for cracks, tear or excess wear, wire brush for loose or cracked wires. If power tool or accessory is dropped, inspect for damage or install an undamaged accessory. After inspecting and installing an accessory, position yourself and bystanders away from the plane of the rotating accessory and run the power tool at maximum no-load speed for one minute. Damaged accessories will normally break apart during this test time.

## OPERATION

### Instructions for Use



**WARNING:** Always observe the safety instructions and applicable regulations.



**WARNING:** To reduce the risk of serious personal injury, turn tool off and disconnect battery pack before making any adjustments or removing/ installing attachments or accessories. An accidental start-up can cause injury.

### Proper Hand Position (Fig. H)



**WARNING:** To reduce the risk of serious personal injury, ALWAYS use proper hand position as shown.



**WARNING:** To reduce the risk of serious personal injury, ALWAYS hold securely in anticipation of a sudden reaction.

Proper hand position requires one hand on the side handle **5**, with the other hand on the auxilliary handle, as shown in Figure H.

### Slider Switch (Fig. A)



**CAUTION:** Hold the main handle and body of the tool firmly to maintain control of the tool at start up and during use and until the wheel or accessory stops rotating. Make sure the wheel has come to a complete stop before laying the tool down.



**NOTE:** To reduce unexpected tool movement, do not switch the tool on or off while under load conditions. Allow the sander to run up to full speed before touching the work surface. Lift the tool from the surface before turning the tool off. Allow the tool to stop rotating before putting it down.

**WARNING:** Before connecting the tool to a power supply, be sure the slider switch is in the off position by pressing the rear part of the switch and releasing. Ensure the slider switch is in the off position as described above after any interruption in power supply to the tool, such as a dead battery.

To start the tool, slide the ON/OFF slider switch ❶ toward the front of the tool. To stop the tool, release the ON/OFF slider switch.

For continuous operation, slide the switch toward the front of the tool and press the forward part of the switch inward. To stop the tool while operating in continuous mode, press the rear part of the slider switch and release.

## Spindle Lock (Fig. 1)

The spindle lock ❸ is provided to prevent the spindle from rotating when installing or removing wheels. Operate the spindle lock only when the tool is turned off, unplugged from the power supply, and has come to a complete stop.

**NOTICE:** To reduce the risk of damage to the tool, do not engage the spindle lock while the tool is operating. Damage to the tool will result and attached accessory may spin off possibly resulting in injury.

To engage the lock, depress the spindle lock button and rotate the spindle until you are unable to rotate the spindle further.

## Surface Grinding, Sanding and Wire Brushing

**CAUTION:** Always use the correct guard per the instructions in this manual.

To perform work on a the surface of a workpiece:

1. Allow the tool to reach full speed before touching the tool to the work surface.
2. Apply minimum pressure to the work surface, allowing the tool to operate at high speed. Material removal rate is greatest when the tool operates at high speed.
3. Maintain an appropriate angle between the tool and work surface. Refer to the chart according to particular function.

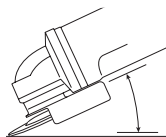

| Function                 | Angle     |
|--------------------------|-----------|
| Grinding                 | 20° - 30° |
| Sanding with Flap Disc   | 5° - 10°  |
| Sanding with Backing Pad | 5° - 15°  |
| Wire Brushing            | 5° - 10°  |

4. Maintain contact between the edge of the wheel and the work surface.
  - If grinding, sanding with flap discs or wire brushing move the tool continuously in a forward and back motion to avoid creating gouges in the work surface.
  - If sanding with a backing pad, move the tool constantly in a straight line to prevent burning and swirling of work surface.

**NOTE:** Allowing the tool to rest on the work surface without moving will damage the work piece.

5. Remove the tool from work surface before turning tool off. Allow the tool to stop rotating before laying it down.

**CAUTION:** Use extra care when working over an edge, as a sudden sharp movement of grinder may be experienced.

## Precautions To Take When Working on a Painted Workpiece

1. Sanding or wire brushing of lead based paint is NOT RECOMMENDED due to the difficulty of controlling the contaminated dust. The greatest danger of lead poisoning is to children and pregnant women.
2. Since it is difficult to identify whether or not a paint contains lead without a chemical analysis, we recommend the following precautions when sanding any paint:

### Personal Safety

1. No children or pregnant women should enter the work area where the paint sanding or wire brushing is being done until all clean up is completed.
2. A dust mask or respirator should be worn by all persons entering the work area. The filter should be replaced daily or whenever the wearer has difficulty breathing.
 

**NOTE:** Only those dust masks suitable for working with lead paint dust and fumes should be used. Ordinary painting masks do not offer this protection. See your local hardware dealer for the proper N.I.O.S.H. approved mask.
3. NO EATING, DRINKING or SMOKING should be done in the work area to prevent ingesting contaminated paint particles. Workers should wash and clean up BEFORE eating, drinking or smoking. Articles of food, drink, or smoking should not be left in the work area where dust would settle on them.

### Environmental Safety

1. Paint should be removed in such a manner as to minimize the amount of dust generated.
2. Areas where paint removal is occurring should be sealed with plastic sheeting of 4 mils thickness.
3. Sanding should be done in a manner to reduce tracking of paint dust outside the work area.

### Cleaning and Disposal

1. All surfaces in the work area should be vacuumed and thoroughly cleaned daily for the duration of the sanding project. Vacuum filter bags should be changed frequently.
2. Plastic drop cloths should be gathered up and disposed of along with any dust chips or other removal debris. They should be placed in sealed refuse receptacles and disposed of through regular trash pick-up procedures.

During clean up, children and pregnant women should be kept away from the immediate work area.

- All toys, washable furniture and utensils used by children should be washed thoroughly before being used again.

## Edge Grinding and Cutting



**WARNING:** Do not use edge grinding/cutting wheels for surface grinding applications because these wheels are not designed for side pressures encountered with surface grinding. Wheel breakage and injury may result.



**CAUTION:** Wheels used for edge grinding and cutting may break or kick back if they bend or twist while the tool is being used. In all edge grinding/cutting operations, the open side of the guard must be positioned away from the operator.

**NOTICE:** Edge grinding/cutting with a Type 27 wheel must be limited to shallow cutting and notching—less than 13 mm in depth when the wheel is new. Reduce the depth of cutting/notching equal to the reduction of the wheel radius as it wears down. Refer to the **Accessory Chart** for more information. Edge grinding/cutting with a Type 41 wheel requires usage of a Type 1 guard.

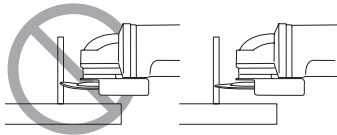

- Allow the tool to reach full speed before touching the tool to the work surface.
- Apply minimum pressure to the work surface, allowing the tool to operate at high speed. Grinding/cutting rate is greatest when the tool operates at high speed.
- Position yourself so that the open-underside of the wheel is facing away from you.
- Once a cut is begun and a notch is established in the workpiece, do not change the angle of the cut. Changing the angle will cause the wheel to bend and may cause wheel breakage. Edge grinding wheels are not designed to withstand side pressures caused by bending.
- Remove the tool from the work surface before turning the tool off. Allow the tool to stop rotating before laying it down.

## Metal Applications

When using the tool in metal applications, make sure that a residual current device (RCD) has been inserted to avoid residual risks caused by metal swarf.

If the power supply is shut off by the RCD, take the tool to an authorised DEWALT repair agent.



**WARNING:** In extreme working conditions, conductive dust can accumulate inside the machine housing when working with metal. This can result in the protective insulation in the machine becoming degraded with a potential risk of an electrical shock.

To avoid build-up of metal swarf inside the machine, we recommend to clear the ventilation slots on a daily basis. Refer to **Maintenance**.

## Cutting Metal

**For cutting with bonded abrasives, always use the guard type 1.**

When cutting, work with moderate feed, adapted to the material being cut. Do not exert pressure onto the cutting disc, tilt or oscillate the machine.

Do not reduce the speed of running down cutting discs by applying sideward pressure.

The machine must always work in an upgrinding motion. Otherwise, the danger exists of it being pushed uncontrolled out of the cut.

When cutting profiles and square bar, it is best to start at the smallest cross section.

## Rough Grinding

**Never use a cutting disc for roughing. Always use the guard type 27.**

The best roughing results are achieved when setting the machine at an angle of 30 ° to 40 °. Move the machine back and forth with moderate pressure. In this manner, the workpiece will not become too hot, does not discolour and no grooves are formed.

## Cutting Stone

**The machine shall be used only for dry cutting.**

For cutting stone, it is best to use a diamond cutting disc. Operate the machine only with additional dust protection mask.

## Working Advice

**Exercise caution when cutting slots in structural walls.**

Slots in structural walls are subject to the country-specific regulations. These regulations are to be observed under all circumstances. Before beginning work, consult the responsible structural engineer, architect or the construction supervisor.

## MAINTENANCE

Your power tool has been designed to operate over a long period of time with a minimum of maintenance. Continuous satisfactory operation depends upon proper tool care and regular cleaning.



**WARNING:** To reduce the risk of serious personal injury, turn tool off and disconnect battery pack before making any adjustments or removing/installing attachments or accessories. An accidental start-up can cause injury.

The charger and battery pack are not serviceable.



## Lubrication

Your power tool requires no additional lubrication.



## Cleaning



**WARNING:** Blow dirt and dust out of the main housing with dry air as often as dirt is seen collecting in and around the air vents. Wear approved eye protection and approved dust mask when performing this procedure.



**WARNING:** Never use solvents or other harsh chemicals for cleaning the non-metallic parts of the tool. These chemicals may weaken the materials used in these parts. Use a cloth dampened only with water and mild soap. Never let any liquid get inside the tool; never immerse any part of the tool into a liquid.

## Optional Accessories



**WARNING:** Since accessories, other than those offered by DeWALT, have not been tested with this product, use of such accessories with this tool could be hazardous. To reduce the risk of injury, only DeWALT recommended accessories should be used with this product.

Consult your dealer for further information on the appropriate accessories.

## Protecting the Environment



Separate collection. Products and batteries marked with this symbol must not be disposed of with normal household waste.

Products and batteries contain materials that can be recovered or recycled reducing the demand for raw materials. Please recycle electrical products and batteries according to local provisions. Further information is available at [www.2helpU.com](http://www.2helpU.com).

## Rechargeable Battery Pack













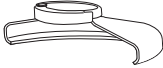

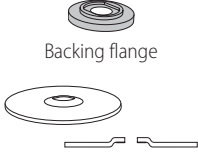
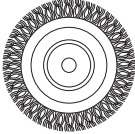
This long life battery pack must be recharged when it fails to produce sufficient power on jobs which were easily done before. At the end of its technical life, discard it with due care for our environment:

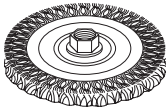
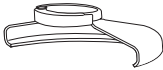
- Run the battery pack down completely, then remove it from the tool.
- Li-Ion cells are recyclable. Take them to your dealer or a local recycling station. The collected battery packs will be recycled or disposed of properly.

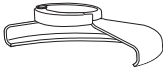

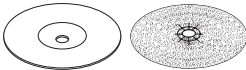
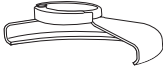



## After Service and Repair

DeWALT service centers are staffed with trained personnel to provide customers with efficient and reliable product service. We do not take any responsibility when you have repaired in unauthorized service center. You can refer to the leaflet of CONTACT CENTER LOCATOR in product package and contact us through hotline, website or social media to find the nearest DeWALT service center around you.

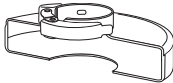
## Accessory Chart

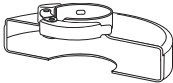
| Guard Type   | Accessory   | Description                    | How to Fit Grinder   |
|--|---|--------------------------------|--|
| <br>Type 27<br>Guard |    | Depressed centre grinding disc | <br>Type 27 guard   |
|  |    | Flap wheel                     |   |
|  |    | Wire wheels                    | Type 27 depressed centre wheel<br><br>Locking flange  |
|  |    | Wire wheels with threaded nut  | <br>Type 27 guard<br><br><br>Wire wheel  |
|  |    | Wire cup with threaded nut     | <br>Type 27 guard<br><br><br>Wire brush   |
|  |  | Backing pad/sanding sheet      | <br>Type 27 guard<br><br><br>Rubber backing pad<br><br><br>Sanding disc<br><br><br>Clamp nut |

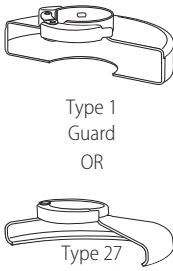
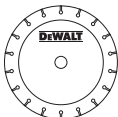
### Accessory Chart (cont.)

| Guard Type  | Accessory   | Description                         | How to Fit Grinder  |
|---|---|-------------------------------------|---|
|  <p>Type 1<br/>Guard</p>                              |  | <p>Masonry cutting disc, bonded</p> |  <p>Type 1 guard</p><br> <p>Backing flange</p>  |
|  <p>Type 1<br/>Guard<br/>OR<br/>Type 27<br/>Guard</p> |  | <p>Diamond cutting wheels</p>       |  <p>Cutting wheel</p><br> <p>Locking flange</p> |

## 滑动开关角磨机

## DCG409

## 恭喜!

感谢您选购 DeWALT 工具凭借多年的产品开发和创新经验, DeWALT 已经成为专业电动工具用户最可靠的合作伙伴之一。

## 技术数据

|              | DCG409-TW                   | DCG409-B1   | DCG409-KR   | DCG409NT-A9 |
|--------------|-----------------------------|-------------|-------------|-------------|
| 电压           | V <sub>DC</sub> 18 (20 Max) | 18 (20 Max) | 18 (20 Max) | 18 (20 Max) |
| 电池类型         | 锂离子                         | 锂离子         | 锂离子         | 锂离子         |
| 最大功率输出       | 瓦 1647                      | 1647        | 1647        | 1647        |
| 额定转速         | min <sup>-1</sup> 9000      | 9000        | 9000        | 9000        |
| 盘片直径         | 毫米 125                      | 100         | 125         | 125         |
| 盘片厚度(最大)     | 毫米 6                        | 4           | 6           | 6           |
| 主轴直径         | M14                         | M10         | M10         | M14         |
| 主轴长度         | 毫米 21.5                     | 16          | 16          | 21.5        |
| 重量(不含电池包) 千克 | 1.81                        | 1.62        | 1.73        | 1.81        |

本信息表给出的振动和/或噪音排放水平已根据 EN60745 中给出的标准化测试进行了测量, 可用于工具对比。可用于初步评估暴露情况。

**警告:** 宣称的振动和/或噪音排放水平代表的是将工具用于主要应用时所发出的振动和/或噪音。然而, 如果将工具用于不同应用, 搭配不同附件或保养不当, 那么振动和/或噪音的情况就会有所不同。这可能会在整个工作期间大幅提升振动和/或噪音的暴露水平。

在预估振动和/或噪音暴露水平时, 还要考虑工具关闭或空转的时候。这可能会在整个工作期间大幅提升振动和/或噪音的暴露水平。

确认额外的安全措施, 保护操作人员免受振动和/或噪音的影响, 例如: 保养工具和附件, 保持双手温暖(与振动有关), 工作形式的组织安排。

**警告:** 为降低伤害风险, 请阅读使用手册。



## 定义: 安全准则

下列定义解释了各警示词的严重程度。请仔细阅读本手册并注意这些标志。



**危险:** 指示紧急的危险情况, 如不加以避免, 将导致死亡或严重伤害。



**警告:** 指示潜在的紧急情况, 如不加以避免, 可能导致死亡或严重伤害。



**警告:** 指示潜在的紧急情况, 如不加以避免, 可能导致轻度或中度伤害。

**注意:** 指示不涉及人身伤害的情况, 如不加以避免, 可能导致财产损失。



指示有触电风险。



指示存在火灾风险。

| 电池            |                   |          |        | 充电器/充电时间(分钟) |        |        |        |         |         |        |         |
|---------------|-------------------|----------|--------|--------------|--------|--------|--------|---------|---------|--------|---------|
| 类别#           | V <sub>DC</sub>   | Ah       | 重量(kg) | DCB104       | DCB107 | DCB112 | DCB115 | DCB117  | DCB118  | DCB132 | DCB1112 |
| DCB546/DCB606 | 18/54 (20/60 Max) | 6.0/2.0  | 1.05   | 60           | 270    | 170    | 90     | 40      | 60      | 90     | 40      |
| DCB547/DCB609 | 18/54 (20/60 Max) | 9.0/3.0  | 1.46   | 75*          | 420    | 270    | 135*   | 60      | 75*     | 135*   | 60      |
| DCB548/DCB612 | 18/54 (20/60 Max) | 12.0/4.0 | 1.44   | 120          | 540    | 350    | 180    | 80      | 120     | 180    | 80      |
| DCB181        | 18 (20 Max)       | 1.5      | 0.35   | 22           | 70     | 45     | 22     | 22      | 22      | 22     | 22      |
| DCB182/DCB204 | 18 (20 Max)       | 4.0      | 0.61   | 60/40**      | 185    | 120    | 60     | 60/40** | 60/40** | 60     | 60/40** |
| DCB183/DCB203 | 18 (20 Max)       | 2.0      | 0.40   | 30           | 90     | 60     | 30     | 30      | 30      | 30     | 30      |
| DCB184/DCB205 | 18 (20 Max)       | 5.0      | 0.62   | 75/50**      | 240    | 150    | 75     | 75/50** | 75/50** | 75     | 75/50** |
| DCB185        | 18 (20 Max)       | 1.3      | 0.35   | 22           | 60     | 40     | 22     | 22      | 22      | 22     | 22      |
| DCB187        | 18 (20 Max)       | 3.0      | 0.54   | 45           | 140    | 90     | 45     | 45      | 45      | 45     | 45      |
| DCB189/DCB240 | 18 (20 Max)       | 4.0      | 0.54   | 60           | 185    | 120    | 60     | 60      | 60      | 60     | 60      |
| DCB186        | 18 (20 Max)       | 6.0      | 0.95   | 60           | 270    | 170    | 90     | 60      | 60      | 90     | 60      |

\*日期码 201811475B 或以后

\*\*日期码 201536 或以后

## 电动工具通用安全警告



**警告:**使用电动工具时,请务必始终遵守下列基本安全预防措施,降低火灾、触电和人身伤害风险。

### 请保管好手册,以备将来查阅

警告中的术语“电动工具”指市电驱动(有线)电动工具或电池驱动(无线)电动工具。

### 1) 工作区的安全

- 保持工作区清洁和明亮。杂乱的工作区及操作台会引发事故。
- 在可能引发火灾或爆炸的场所,例如存在易燃液体、气体的地方,请勿使用本工具。电动工具产生的火花会点燃粉尘或气体。
- 操作电动工具时,请远离儿童和旁观者。注意力不集中会让你失去对工具的控制。

### 2) 电气安全

- 电动工具插头必须与插座相配。不得以任何方式改装插头。需接地的电动工具不能使用任何转换插头。未经改装的插头和相配的插座将降低电击风险。
- 避免人体接触接地表面,如管道、散热片和冰箱。如果你身体接触接地表面会增加电击风险。
- 请勿将电动工具暴露在雨中或潮湿环境中。水进入电动工具将增加电击风险。
- 切勿滥用电源线。切勿通过提拉电源线搬运工具,或以直接插插座拽下电源线的方式断开电源。请确保电源线远离高温、油和利边。受损或缠绕的电源线会增加触电风险。
- 当在户外使用电动工具时,使用适合户外使用的延长线。适合户外使用的电源线将降低触电风险。
- 如果无法避免在潮湿环境下操作电动工具,应使用带有剩余电流装置(RCD)保护的电源。RCD的使用可降低触电风险。

### 3) 人身安全

- 保持警觉,当操作电动工具时关注所从事的操作并保持清醒。当您感到疲倦,或在出现药物、酒精或治疗反应时,请勿操作电动工具。在操作电动工具时瞬间的疏忽会导致严重人身伤害。
- 使用个人防护装置。始终佩戴护目镜。防护装置,诸如适当条件下使用防尘面具、防滑安全鞋、安全帽、听力防护等装置能减少人身伤害。
- 防止意外起动。在连接电源和/或电池包以及拿起或搬运工具前,请确保开关处于关断位置。手指放在开关上搬运工具或开关处于接通时通电会导致危险。
- 在电动工具接通之前,拿掉所有调节钥匙或扳手。遗留在电动工具旋转零件上的扳手或钥匙会导致人身伤害。
- 请勿让手过分伸展。时刻保持身体平衡,并找到合适的落脚点。这样能在意外情况下能更好地控制住电动工具。
- 适当着装。请勿穿着宽松服装或佩戴首饰。长发人员应佩戴防护性发套。防止将服装或首饰卷入活动的部件中。
- 如果该设备配有用来连接吸尘和集尘设备的装置,请确保它们已连接好并能恰当使用。使用集尘装置可降低尘屑引起的危险。
- 请勿因为频繁使用工具而产生的熟悉感而掉以轻心,忽视工具的安全准则。某个粗心的动作可能在瞬间导致严重伤害。

### 4) 电动工具使用和注意事项

- 请勿强制使用本工具。根据用途使用合适的电动工具。以工具的预期速率进行使用可确保工作更加安全有效。
- 如果开关不能接通或关断电源,则不能使用该电动工具。不能通过开关来控制电动工具是危险的且必须进行修理。
- 在进行任何调节、更换附件或贮存电动工具之前,必须从电源上拔掉插头和/或卸下电池包(如可拆卸)。这种防护性的安全措施降低了电动工具意外起动的风险。
- 将闲置不用的电动工具贮存在儿童所及范围之外,并且不允许不熟悉电动工具和不了解这些说明的人操作电动工具。电动工具在未经培训的使用者手中是危险的。
- 维护电动工具及其附件。检查运动部件是否调整到位或卡住,检查零件破损情况和影响电动工具运行的其他状况。如有损坏,应在使用前修理好电动工具。许多事故是由维护不良的电动工具引发的。
- 保持切削刀具锋利和清洁。维护良好地有锋利切削刃的刀具不易卡住而且容易控制。
- 请根据使用说明来选择电动工具、附件和工具的刀头等,同时要考虑工作条件和要进行的工作。将电动工具用于那些与其用途不符的操作可能会导致危险情况。
- 保持手柄和握持表面干燥、清洁,不油腻。在意外情况下,湿滑的手柄无法让您安全地握持工具,保证对工具的控制。

### 5) 电池工具的使用与注意事项

- 仅用制造商指定的充电器为设备充电。如果将适用于一种电池包类型的充电器为另一种类型的电池包充电,可能会引发风险。
- 仅使用带有专门设计的电池包的电动工具。如果使用任何其他电池包,可能会造成受伤和火灾的风险。
- 如果不使用电池包,请让其远离能够接通电池两极的其他金属物体,例如回形针、硬币、钥匙、钉子、螺钉或其他小型金属物体。短接电池端子可能会引发燃烧或火灾。
- 在滥用电池的情况下,电池液会从电池中喷出;应避免接触电池液。如果不慎接触电池液,请用水冲洗。如果电池液接触到双眼,请立即就医。从电池中喷出的电池液可能会引起发炎或灼烧。
- 请勿使用已经损坏或改动的电池包或工具。损坏或改动的电池可能表现出不可预计的行为,导致火灾、爆炸或伤害风险。
- 请勿让电池包或工具暴露于明火或高温环境中。暴露于明火或温度超过 130°C 的环境中,可能导致爆炸。
- 请遵循所有充电说明,请勿在说明规定的温度范围以外的环境中为电池包或工具充电。不当充电,或在超出指定范围的温度下充电,可能会损坏电池,增加火灾风险。

### 6) 维修

- 请让专业维修人员使用相同的备件维修电动工具。这将保证所维修的电动工具的安全。
- 不得维修损坏的电池包。电池包的维修应仅由制造商或授权服务提供商执行。

## 额外的安全规则

### 所有操作的安全说明

- 本电动工具设计用作砂轮机、砂光机、钢丝刷或切割工具。请阅读本电动工具随附的所有安全警告、指示、图示和视

格。若未能遵守以下说明，可能会导致触电、火灾和人身伤害。

- b) **不建议使用本电动工具执行抛光等操作。**如果将电动工具用于适用范围以外的操作，可能会引发危险，造成人身伤害。
- c) **请勿使用非工具制造商专门设计及推荐的配件。**虽然该配件可被装到电动工具上，但无法保证安全运行。
- d) **配件的额定速度必须至少等于电动工具上所标的最大速度。**如果配件的运行速度高于其额定速度，可能会引发爆裂和飞溅。
- e) **配件的外径与厚度必须在电动工具的额定范围内。**如果配件尺寸错误，就无法得到充分保护或控制。
- f) **配件的螺纹安装必须与角磨机主轴的螺纹相匹配。**对于通过法兰安装的配件，其轴孔尺寸必须与法兰的定位直径相匹配。与电动工具安装硬件不匹配的配件将会失衡，过度振动并导致工具失控。
- g) **请勿使用受损配件。**每次使用前，请检查配件，例如检查砂轮是否碎裂，有无裂缝，检查支撑垫有无裂缝、撕裂或过度磨损，检查钢丝刷是否松动或钢丝是否断裂。如果电动工具或配件掉落，检查是否有损坏，或安装没有损坏的配件。检查和安装配件后，请让自己和旁观者远离转动配件，并以用最大空载速度让工具运行一分钟。已经受损的配件一般会在此测试过程中碎裂。
- h) **请使用个人防护装置。**请根据使用情况，佩戴面罩、安全护目镜或安全眼镜。在适当情况下，请佩戴防尘面具、听力保护器、手套以及能阻挡细小磨料或工件碎片的工作围裙。防护眼罩必须要能够挡住操作时产生的碎屑。防尘面具或口罩必须能够过滤操作时产生的各种颗粒。长期暴露在高强度的噪声中会引起失聪。
- i) **请让旁观者与工作区域保持一定的安全距离。**任何进入工作区域的人必须穿戴个人防护设备。工件或破损配件的碎片可能会飞出，让工作区域附近的旁观者受伤。
- j) **如果操作过程中，工具的切削附件可能会触碰到隐藏在墙内的电线，那么只能通过绝缘握持面握住电动工具。**紧固件碰到带电导线会使工具外露的金属零件带电而使操作人员受到电击。
- k) **请等到配件完全停止转动，才可放下电动工具。**转动的配件可能会切入表面，进而拉动电动工具，让您失去对工具的控制。
- l) **在携带电动工具时，请勿启动它。**如果意外接触到转动的配件，可能会让您的衣服卷入其中，从而让配件对您造成人身伤害。
- m) **请定期清洁工具的排气道。**电动机的风扇会将灰尘吸进机壳。如果其中沉积了过多的金属粉尘，就容易引发电气危险。
- n) **请勿在易燃材料附近操作电动工具。**操作工具时产生的火星可能会点燃这些材料。
- o) **请勿使用需要冷却液的配件。**用水或其他冷却液可能会导致电击致死或触电。
- p) **请勿在本工具上使用 11 号（杯形）砂轮。**使用不合适的配件可能会导致伤害。
- q) **请始终使用侧手柄。请紧握手柄。**应始终使用侧手柄，以时刻保持对工具的控制。

**警告：**建议使用剩余电流额定值不超过 30 毫安的剩余电流保护装置。

## 面向所有操作的进一步安全说明

### 回弹的原因及操作人员可采用的预防措施

回弹是由被卡住或被缠绕住的旋转砂轮、支撑垫、钢丝刷或任何其他配件产生的一种突然的反作用力。卡住或缠绕会引起转动配件立刻失速，紧接着，失控的电动工具在夹紧点就会产生与配件转向相反的运动。

例如，若砂轮被工件缠绕或卡住，那么进入夹紧点的砂轮边缘就会嵌入材料表面，从而导致砂轮会从中爬出或弹出。砂轮可能会飞向操作人员，或逃离操作人员，这取决于砂轮在夹紧点的转向。在此情况下，砂轮也可能会碎裂。

回弹是由于电动工具使用不当及/或不正确的操作程序或条件而导致的。可通过下列适当的预防措施加以避免：

- a) **始终握紧工具，同时调整好身体和手臂位置，以抵御回弹。**务必使用辅助手柄（如提供），以最大限度地控制启动时的回弹或反扭矩。若采取合适的预防措施，操作人员即可控制反扭矩或回弹。
- b) **不得将手靠近切割区域。**配件可能会回弹，碰到您的手。
- c) **请勿站在电动工具在回弹时可移动到的位置。**回弹将迫使工具在夹紧点上逆着砂轮的转向运动。
- d) **处理尖角、锐边等时请格外小心。**避免附件弹跳以及被缠绕。尖角、锐边或弹跳会缠住转动配件，导致工具失控或出现回弹。
- e) **请勿装上锯链、木锯片或齿状锯片。**此类锯片会导致频繁的回弹和失控。

## 针对研磨和磨料切割操作的安全警告

- a) **仅使用为您的电动工具所推荐的砂轮型号，以及为所选砂轮专门设计的防护罩。**如果不是专为电动工具设计的砂轮，就难以得到充分保护，不够安全。
- b) **中心凹轮的研磨表面必须安装于防护罩边缘平面之下。**如果砂轮安装不当，超出了防护罩边缘平面，就无法得到充分保护。
- c) **必须将防护罩牢固地安装在工具的适当位置上，提供充分的安全防护，仅让砂轮的极少部分暴露在操作人员面前。**防护罩能帮助操作人员阻挡爆裂的砂轮碎片，让其避免意外触碰砂轮，同时隔离可引燃衣物的火星。
- d) **仅可将砂轮用于推荐的用途。例如，请勿将切割砂轮的侧面用于研磨操作。**切割砂轮被设计用于圆周研磨，施加到砂轮的侧面应力可能会使砂轮破碎。
- e) **务必为所选砂轮选用未损坏，而且尺寸、形状均合适的砂轮法兰。**合适的砂轮法兰可支撑砂轮，降低其破裂的可能性。切割砂轮的法兰可能不同于研磨砂轮的法兰。
- f) **请勿使用大规格电动工具上用剩的磨损砂轮。**用于大规格电动工具的砂轮不适用于小规格工具的高速工况，可能会爆裂。

## 针对磨料切割操作的额外安全警告

- a) **请勿“夹”住切割砂轮或施加过大的压力。请勿试图进行过深的切割。**若向砂轮施加过大的应力，就会增加砂轮在切削时的负荷，使其容易被缠绕或卡住，还会增加回弹或爆裂的可能性。
- b) **请勿让自己与转动的砂轮呈一条直线，也不得站在砂轮的后面。**在将处于操作点的砂轮从操作人员身边移开时，可能产生回弹，从而迫使砂轮和电动工具都朝您所在的方向移动。





- c) 如果砂轮被卡住,或因任何原因中断切割,请关闭电动工具并握住不动,等待砂轮完全停止。当砂轮仍在转动时,不得试图将其从切割操作中移开,这样可能会引发回弹。检查并采取纠正措施,消除砂轮被卡住的原因。
- d) 请勿在工件中重启切割操作。先让砂轮全速运转,然后再小心地重新切入。若电动工具在工件中重新启动,砂轮可能会卡住、爬出或回弹。
- e) 为板材或任何超大工件提供支撑,最大限度地降低砂轮卡住和回弹的风险。大型工件由于自身重量,存在下陷的倾向。必须在工件靠近切线处及砂轮两侧靠近工件边缘处放置支撑。
- f) 在对现有墙体或其他盲区进行“盲切割”时,应格外小心。伸出的砂轮可能会割到气管、水管、电线或由此引起回弹的物体。

## 针对砂光操作的安全警告

- a) 请勿使用尺寸过大的砂盘纸。请遵循制造商的建议选用砂纸。超出砂盘的大规格砂纸会造成割伤危害并会让砂轮被缠绕、撕裂或出现回弹。

## 针对钢丝刷操作的安全警告

- a) 请注意,即使在正常操作时,钢丝刷也会掉落钢丝。请勿对钢丝刷施加过多负荷,以免对钢丝施加过大应力。钢丝刷可轻松地刺穿单薄衣物及/或皮肤。
- b) 若建议钢丝刷使用防护罩,则不可让钢丝轮或钢丝刷干扰到防护罩。钢丝轮或钢丝刷的直径可能会因为特定的应用场景以及重力的作用而扩大。

## 剩余风险

尽管遵守了相关安全法规并采用安全装备,但某些剩余风险是不可避免的,它们是:

- 听力损伤。
- 飞散的颗粒引起的人身伤害风险。
- 操作过程中配件发烫引起的灼烧风险。
- 长时间使用引起的人身伤害风险。
- 危害物质粉尘引起的风险。

## 充电器

DeWALT 充电器无需调节,专为简单易用而设计。

### 电气安全

电机只适用一种工作电压。请务必检查电池包的电压是否与铭牌一致,并确保充电器的电压与电源电压一致。



DeWALT 充电器符合 IEC60335 双重绝缘要求,因此无需使用接地线。

如果电源线损坏,必须由 DeWALT 或授权的维修机构负责更换。

### 使用延长线

如非绝对必要,否则请勿使用延长电线。请使用与充电器输入功率相匹配且经过认证的延长线(请参阅**技术数据**)。导体的最小横截面尺寸为 1 平方毫米;最长为 30 米。

使用电缆卷筒时,每次必须把电缆完全展开。

### 面向所有电池充电器的重要安全说明

请妥善保管这些说明:本手册包含有关兼容电池充电器的重要安全和操作说明(请参阅**技术数据**)。

- 在使用充电器前,请先阅读所有说明以及充电器、电池包以及使用该电池包的产品上的警告标记。



**警告:**触电危险不得让任何液体进入充电器,这可能会导致触电。



**警告:**建议使用剩余电流额定值不超过 30 毫安的剩余电流保护装置。



**警告:**灼烧危险。为降低受伤风险,仅使用 DeWALT 可充电的电池。其他非原厂电池可能会爆裂,导致人身伤害和损害。



**警告:**必须监督儿童,确保他们不会将工具当做玩具玩耍。

**注意:**在某些情况下,在为充电器接通电源后,充电器内暴露的充电触头会因为异物而导致短路。导电的异物,包括但不限于钢丝绒、铝箔纸或任何堆积的金属颗粒。应让它们远离充电器。在电池腔内没有电池时,务必切断充电器的电源。请先拔掉电源插头,再清洁充电器。

- 请勿尝试使用本手册中未提及的充电器为电池包充电。充电器与电池包采用特别设计,适合搭配使用。
- 除了为 DeWALT 可充电电池充电之外,这些充电器不可被用于其他用途。若用作其他用途,就存在火灾、触电或电击致死的风险。
- 请勿将充电器暴露在雨、雪之中。
- 切断充电器的电源时,请握住插头并将其拔出,而非通过拉扯电线的方式拔出插头。这样会降低电源插头及电线损坏的风险。
- 请确保电线所在位置不会被踩踏,电线不会将人绊倒或受到其他的损坏或压力。
- 除非必要,否则请勿使用延长线。使用不适当的延长线会引起火灾、触电或电击致死。
- 请勿将任何物件置于充电器上,或是把充电器放在可能会堵住通风槽的柔软表面,从而导致充电器内部过热。请让充电器远离任何热源。充电器通过顶部的通风槽和外壳的底部进行通风散热。
- 请勿使用电线或插头损坏的充电器——请立即更换。
- 如果充电器受到重击、坠落或出现其他损坏情况,请勿使用,并将其送到授权维修中心维修。
- 不得自行拆卸充电器。需要维护或维修时,请送至授权维修中心。不当的重新组装可能会导致触电、电击致死或火灾。
- 若电源线损坏,必须由制造商、服务代理或类似的具有资质的人员立即更换,避免发生危险。
- 在进行任何清洁前,先将充电器从插座上拔下。这样会降低触电风险。取出电池包不会降低该风险。
- 不得试图将两个充电器连接在一起。
- 该充电器可在标准的 220-240V 家用电源上工作。请勿试图在任何其他电压环境中使用该充电器。这一点不适用于车载充电器。

### 为电池充电(图 B)

1. 先将充电器插入适当的插座中,然后再插入电池包。
2. 将电池包插入 **10** 充电器,确保电池包已安装到位。红灯(充电中)会重复闪烁,表示充电已经开始。
3. 红灯常亮,表示充电完成。此时,电池包的电量全满,可以立即使用或是将其留在充电器内。若要从充电器中取出电池包,请按下电池包 **11** 的电池释放按钮。

**注意:**为确保锂离子电池包的效能,同时让使用寿命最大化,在第一次使用电池包前,必须为其完全充电。

## 充电器的操作

如需了解电池包的充电状态，请参阅以下说明。



\*红灯持续闪烁，但在执行此操作期间，会有黄灯亮起。当电池包达到适当温度后，黄灯熄灭，充电器将恢复充电程序。

此兼容充电器不能为有故障的电池包充电。此时，指示灯不会亮起，表示电池包存在故障。

**注意：**这也可能是充电器发生故障。

如果充电器发生故障，请将充电器和电池包送至授权维修中心进行测试。

### 电池包热/冷延迟

当充电器检测到电池包过热或过冷，就会自动进入热/冷电池包延迟状态，暂停充电，直到电池包恢复到适当温度为止。然后，充电器将自动切换到电池包充电模式。该特色功能可以最大程度地延长电池包的使用寿命。

冷电池包的充电速度大约是暖电池包的一半。在整个充电周期，电池包会以较慢的充电速度进行充电，即使电池包变暖，充电速度也不会恢复到最大充电速度。

DCB118 充电器配备了一个内置风扇，可冷却电池包。该风扇会在电池包需要冷却时启动。如果风扇运转异常或通风槽被堵塞，不得使用充电器。请勿让异物进入充电器内。

### 电子保护系统

XR 锂离子工具的设计带有电子保护系统，可保护电池包，避免过载、过热或深度放电。

如果电子保护系统介入，则该工具将自动关闭。如果出现此情况，请将锂离子电池包放进充电器内，直到电量全满为止。

### 墙面安装

这些充电器可以安装在墙面上，或在直立于桌面或作业表面的地方安装。若要安装于墙面，请将充电器的位置定在电源插座附近，同时要远离墙角或能阻挡气流的其他障碍。将充电器的背面作为模板，以此确定安装螺钉在墙面上的位置。使用长度至少 25.4 毫米、螺钉直径为 7-9 毫米的墙用螺钉（另售）来安装充电器。当螺钉留在木料外部的长度约为 5.5 毫米时，此为螺钉旋进木料的最佳深度。将露出的螺钉与充电器背面的滑槽对齐，并与之完全接合。

### 充电器清洁说明

**警告：触电危险在清洁前，请从交流电源插座上拔下充电器的插头。**使用软布或非金属软刷，去除充电器外部的污垢和油脂。请勿使用水或任何清洁剂。不得让任何液体渗入工具；不得让工具的任何部件浸在液体中。

## 电池包

### 面向所有电池充电器的重要安全说明

购买用于更换的电池包时，务必附上产品目录号和电压信息。

电池包的电量在出厂时并非充满。在使用电池包和充电器之前，请先阅读以下安全说明，并遵循所列的充电程序。

### 请阅读所有说明

- **请勿在易爆环境，如有易燃液体、气体或粉尘的环境中进行充电或使用电池。**将电池包放进充电器或拆除电池可能会点燃粉尘或气体。
- **不得强行将电池放进充电器。请勿以任何方式改装电池包，以在不兼容的充电器中使用，否则电池包可能会破裂，导致严重人身伤害。**
- 请仅使用指定的 DeWALT 充电器为电池充电。
- **请勿**让水或其他液体溅到电池包上，或将电池包浸没在水或其他液体中。
- **请勿在温度可能低于 4 °C (39.2 °F) (如冬天户外的棚子或金属建筑物中)，或在温度可能达到或超过 40 °C (104 °F) 的地方(如夏天户外的棚子或金属建筑物中)存储或使用工具和电池包。**
- **即使电池包严重受损或电量完全用尽，也不得将其焚烧。**电池包在火中可能会爆炸。在焚烧锂离子电池包时，会产生有毒的气体和物质。
- **如果电池内容物接触到皮肤，请立即用温和的肥皂和清水冲洗。**如果电池液体进入眼睛，请睁开眼睛并用清水冲洗 15 分钟或一直冲洗，直到不适感消失为止。如需立即就医，请知悉，电池的电解液由液体有机碳酸盐和锂盐混合而成。
- **被打开的电池的内容物可能刺激呼吸道。**提供新鲜空气。如果症状持续，请立即就医。



**警告：灼烧危险。**如果将电池液暴露在火花或明火中，可能会燃烧。



**警告：**不得以任何理由尝试拆开电池包。如果电池包的外壳破裂或损坏，请勿放进充电器。请勿撞击、摔落或损坏电池包。请勿使用受到重击、坠落或出现其他损坏情况的电池包或充电器（例如钉子刺穿、以锤子敲打或踩踏）。这可能会导致触电或电击致死。损坏的电池包应该送至维修中心进行回收。



**警告：火灾危险。请勿在储存或搬运电池包时，让金属物件接触暴露在外的电池两极。**例如，请勿将电池包放在带有零散摆放的钉子、螺钉、钥匙等地方（如围裙、口袋、工具箱、产品包装箱、抽屉等）。



**小心：在不使用工具时，请将工具放在稳定的表面上，以免出现被工具绊倒或工具掉落等危险。**一些带有大型电池包的工具可以直立摆放，但容易被撞倒。

### 运输



**警告：火灾危险。**电池运输途中，若两极意外接触导电材料，可能会引发火灾。运输电池时，确保电池两级受到保护并与可能接触两级并导致短路的材料隔绝。**注意：**锂离子电池不应放在托运行李中。

DeWALT 电池符合行业和法律标准（包括联合国危险货物运输建议书、国际航空运输协会 (IATA) 危险物品处理规则、国际海运危险物品 (IMDG) 处理规则以及国际公路运送危险物品欧洲协议 (ADR) 规定的所有适用运输规章。锂离子电池和电池包均已根据《联合国危险货物运输建议书测试与标准手册》第 38.3 节的规定进行测试。

大多数情况下，不会将运输 DeWALT 电池包分归为完全管制的第 9 类危险品。一般只有在运输中包含额定能量大于 100 瓦时 (Wh) 的锂离子电池时，才会将其分归为完全管制的第 9 类危险品。所有锂离子电池外壳上均标注有瓦时等级。此外，由于规章的复杂性，DeWALT 不建议对锂离子电池包单独采用空运，不论其额定能量是多少瓦时，都是如此。若电池包的额定能量不超过 100 瓦时，可以同时空运工具与电池包（组合套件）。

无论运输是否纳入完全管制范围内，运输方均有责任咨询了解针对包装、标签/标记及单据要求的最新规定。

该部分提供的信息基于良好商誉原则，而且在制作文件时，这部分的信息被视为准确无误。然而，我们不会做出任何直接或间接的保证。买方负有确保其行为遵守适用法规的责任。

### 运输 FLEXVOLT™ 电池

DeWALT FLEXVOLT™ 电池有两种模式：**使用和运输**。

**使用模式：**若 FLEXVOLT™ 电池单独使用或在 DeWALT 18 伏（最大 20 伏）产品中使用，将作为 18 伏（最大 20 伏）特电池运作。若 FLEXVOLT™ 电池在 54 伏（最大 60 伏）或 108 伏（最大 120 伏）（两个 54 伏（最大 60 伏）电池）产品中使用，将作为 54 伏（最大 60 伏）电池运作。

**运输模式：**将护盖连接至 FLEXVOLT™ 电池时，电池将处于运输模式。在运输时，请将保护盖盖在电池上。

在运输模式下，若将电池包内的一连串电池中断电气连接，会导致 3 个电池各自的瓦时 (Wh) 额定值低于 1 个电池包的瓦时额定值。这样电池数量虽然增加到 3 个，但瓦时额定值更低，因此能避开针对较高瓦时电池的运输规章。

例如，若运输瓦时额定值为 3 x 36 瓦时，表示运输 3 个电池，每个电池的额定值为 36 瓦时。使用瓦时额定值可能为 108 瓦时（表示 1 个电池）。

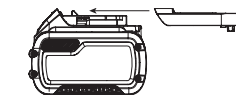

使用示例和运输标签标记



### 存放建议

1. 干燥、凉爽、没有阳光直射、不会过热或过冷的地方最适合存放电池包。为达到最大效能和使用寿命，不使用电池时，请将其存放在室温环境中。
2. 如需长期存放，建议将电量全满的电池包从充电器上卸下并存放于凉爽、干燥处，使电池包效能达到最佳。

**注意：**在存放电池包时，其电量不应完全耗尽。在使用前，必须为电池包再次充电。

### 充电器和电池包上的标签

除本手册图示之外，充电器和电池包上的标签包含以下图示：

 使用前请阅读使用手册。



 充电时间请参见**技术数据**。

 请勿插入导体。

 请勿为损坏的电池包充电。

 请勿暴露在水中。

 立即更换损坏的电线。

 仅可在温度介于 4°C 至 40°C 之间的环境中充电。

 仅供室内使用。

 丢弃电池包时要注意环保问题。  
LI-ION

 只使用指定的 DeWALT 充电器为 DeWALT 电池包充电。使用 DeWALT 充电器对指定的 DeWALT 电池以外的电池包充电会爆裂或导致其他危险情形。

 请勿焚化电池包。

 使用（无运输电池盖）。示例：瓦时额定值为 108 瓦时（具有 108 瓦时的 1 个电池）。

 运输（有内建运输电池盖）。示例：瓦时额定值为 3 x 36 瓦时（具有 36 瓦时的 3 个电池）。

### 电池类型

使用最大 18（最大 20 伏）的电池包：DCG409。

可以使用以下电池包：DCB181, DCB182, DCB183, DCB183B, DCB184, DCB184B, DCB185, DCB186, DCB187, DCB189, DCB203, DCB204, DCB205, DCB240, DCB546, DCB547, DCB548, DCB606, DCB609, DCB612。更多信息，请见**技术数据**。

### 包装内的物品

本包装内含有：

- 1 台角磨机
- 1 个 125 毫米防护罩（类型 27）
- 1 个侧手柄
- 1 个法兰组
- 1 个六角扳手
- 1 锂电池包 (C1, D1, L1, M1, P1, S1, T1, X1, Y1 型号)
- 2 锂电池包 (C2, D2, L2, M2, P2, S2, T2, X2, Y2 型号)
- 3 锂电池包 (C3, D3, L3, M3, P3, S3, T3, X3, Y3 型号)
- 1 本说明手册

**注意：**N 型号不包括电池包、充电器和工具箱。NT 型号不包括电池包和充电器。B 型号包括 Bluetooth® 电池包。

**注意：**Bluetooth® 文字标记和徽标是归 Bluetooth®, SIG, Inc. 所有的注册商标，DeWALT 对此类标记的任何使用均获得许可。其他商标和商品名称归其各自所有者所有。

- 检查工具、部件或配件是否在运输过程中损坏。
- 使用前，请认真阅读并掌握本手册的内容。

### 工具上的标识

工具上印有下列图形：

 使用前请阅读使用手册。

 请佩戴听力保护器。

 请佩戴护目装备。

## 日期代码位置 (图 E)

包含制造年份的日期码 **12** 打印在工具外壳上。

示例:

2021 XX XX

制造年份和周

## 说明 (图 A)

**警告:** 不得改装本电动工具或其任何部件。否则, 可能造成人身伤害或工具损坏。

- 1 滑动开关
- 2 锁定杆
- 3 主轴锁定按钮
- 4 主轴
- 5 侧手柄
- 6 支撑法兰
- 7 锁定法兰
- 8 防护罩
- 9 防护罩释放杆
- 10 电池包
- 11 电池释放按钮

## 设计用途

您的 DCG409 无线角磨机为专业的切割、研磨、砂光和钢丝刷工具。

**请勿**在潮湿或存在易燃液体、气体的环境中使用本工具。

这款无线角磨机是专业电动工具。

**请勿**让儿童接触本工具。无使用经验的人必须在监督下使用本工具。

- **儿童和体弱者。** 幼童和体弱者不适合在无人监管的情况下使用本工具。
- 本产品不适合体力、感官或智力不足以及缺乏经验、知识或技能的人员 (包括儿童) 使用, 除非一旁有能为他们的安全负责的监督人员。不得在无人监管的情况下让儿童接触本产品。

## 功能部件

### 无电压开关

如果断电, 无电压开关能让角磨机在不循环开关的情况下停止研磨机重新启动。

### 电子离合器

该工具装有 E-Clutch™ (电子离合器)。该装置在高负荷或砂轮被卡住的情况下, 能够关闭工具, 减少工具对用户产生的反扭矩。如需重启工具, 需要循环开关 (打开和关闭开关)。

### Kickback Brake™

在感应到出现卡住、失速或缠绕情况时, 电子制动器会通过啮合产生最大力量, 让砂轮迅速停下, 减缓角磨机的运动, 并将其关闭。需要先松开开关, 再按下开关, 才能重启工具。

### Power-OFF™ 过载保护

在电机过载时, 将减少对电动机的电力供应。若电机持续过载, 就会将工具关闭。需要先松开开关, 再按下开关, 才能重启工具。每当电流负荷达到过载电流值 (电机燃耗点) 时, 都会将工具断电。若因持续过载而导致工具被关闭, 请减轻施加在工具上的力度/重量, 直到工具能在无过载啮合的状况下正常运行为止。

### 缓启动装置

凭借缓启动装置, 可以缓慢提速, 以避免在启动初期的颤动。当您有限空间内工作, 此功能尤其有用。

## 防振侧手柄

防震侧手柄可以吸收工具产生的振动, 从而提升舒适度。

## 组装与调整

**警告:** 为了降低造成严重人身伤害的风险, 在进行任何调整或卸下或安装附件或配件前, 切记关掉工具的电源并取出电池包。意外启动容易造成人身伤害。

**警告:** 请仅使用 DeWALT 电池包与充电器。

## 插入或取出工具上的电池包 (图 B)

**注意:** 请确保电池包 **10** 电量已完全充满。

### 将电池包安装到工具手柄中

1. 将电池包 **10** 与工具手柄内的轨道对齐 (图 B)。
2. 将电池包滑入手柄, 直到电池包在工具内被牢牢固定, 同时确保听到锁定到位的声音。

### 卸下工具内的电池包

1. 按下释放按钮 **11**, 将电池包从工具手柄中稳妥地拉出。
2. 请按照本手册中充电器章节所述, 将电池包放进充电器。

## 电量计电池包 (图 C)

一些 DeWALT 电池包带有包含三个绿色 LED 灯的电量计, 可以显示电池包的剩余电量。

如需启动电量计 **19**, 请长按电量计按钮。这三个绿色 LED 灯将会相应亮起, 诊断电池包中的剩余电量。若剩余电量低于可用下限, 电量计将不会亮起, 此时需要为电池包充电。

**注意:** 电量计只是提示电池包中的剩余电量。它无法显示工具的功能, 而且其显示情况也会随着工具组件、温度和最终使用者的应用的不同而有所变化。

## 安装侧手柄 (图 C)

**警告:** 使用工具前, 请检查手柄是否紧固。

将侧手柄 **5** 旋入齿轮箱任意一侧的某一个孔中并将其拧紧。应始终使用侧手柄, 时刻保持对工具的控制。

## 转动齿轮箱 (图 D)

为了提高用户的舒适度, 齿轮箱能够为切削操作转动 90°。

1. 移除用于安装齿轮箱到电动机外壳上的四个角螺钉。
2. 无需将齿轮箱与电动机外壳分开, 将齿轮箱前端转动到所需位置。

**注意:** 如果齿轮箱与电动机外壳分开距离超出 3.17 毫米, 则必须将本工具交由授权的 DeWALT 维修中心维修和重新组装。若不维修本工具, 可能导致电动机与轴承发生故障。

3. 重新安装螺钉以将齿轮箱安装到电动机外壳。以 12.5 英寸-磅的扭矩拧紧螺钉。过分拧紧会损坏螺钉。

## 防护罩

**小心:** 防护罩必须与所有的研磨砂轮、切削砂轮、砂纸盘、钢丝刷及钢丝轮一同使用。仅在使用常规砂盘进行砂光操作时, 可以不使用防护罩。请参见图 A, 了解装置随附的防护罩。某些应用可能需要从本地经销商或授权服务中心购买适当的防护罩。

**注意:** 边缘研磨与切削可采用专为此用途设计并指定的 27 号砂轮进行; 6.35 毫米厚的砂轮用于表面研磨, 而更薄的 27 号砂轮需要检查制造商的标签, 以查看该砂轮能否用于表面研磨, 或者只能用于

边缘研磨/切削。如要禁止表面研磨，则必须在所有砂轮上使用 1 号防护罩。切削也可以采用 41 号砂轮和 1 号防护罩进行。

**注意：**参见**配件表**，选取适当的防护罩/配件组合。

### 安装和调整 One-Touch™ 防护罩 (图 E)

**警告：**为降低严重人身伤害的风险，在进行任何调整或卸下或安装配件前，请先切断工具电源并取出电池包。意外启动容易造成人身伤害。

#### 调整防护罩

如需调整防护罩，请用棘轮功能，将防护罩释放杆 9 与防护罩套筒上的某一个定位孔 15 对齐。

当顺时针转动防护罩（主轴朝向用户），同时进行逆时针自锁时，这个接合面就会倾斜并越至下一个定位孔。

#### 安装防护罩 (图 E)

- 按下防护罩释放杆 9。
- 让防护罩释放杆保持打开状态，同时将防护罩上的接片 13 与齿轮箱上的滑槽 14 对齐。
- 让防护罩释放杆保持打开状态，向下按压防护罩，直到接片接合为止，然后在齿轮箱轮毂的凹槽中转动接片。松开防护罩释放杆。
- 让主轴面对操作人员，将防护罩顺时针转动到理想位置。长按防护罩释放杆 9，以逆时针转动防护罩。

**注意：**防护罩主体应位于主轴和操作人员之间，最大程度地为操作人员提供保护。

防护罩释放杆应与防护罩套筒上的某个定位孔 15 锁定。这能确保防护罩足够稳固。

- 如需拆除防护罩，请按照步骤 1-3 的说明反向操作。

## 法兰和砂轮

### 安装不带轮毂的砂轮 (图 F)

**警告：**如果未能正确放置法兰/紧固螺母/砂轮，可能会导致严重人身伤害（或者损坏工具或砂轮）。

**小心：**随附的法兰必须与 27 号和 42 号中心凹轮以及 41 号切削砂轮搭配使用。参见**配件表**，了解更多信息。

**警告：**在使用切削砂轮时，需要使用封闭式双面切削砂轮防护罩。

**警告：**使用受损的法兰或防护罩，或者未使用适当的法兰或防护罩，可能会由于砂轮破损或砂轮接触而导致人身伤害。参见**配件表**，了解更多信息。

- 将工具放在工作台上，防护罩朝上。
- 将支撑法兰 6 安装到主轴 4 上，让凸起的中心（导杆）面向砂轮。按下支撑法兰使其就位。
- 将砂轮 20 紧靠支撑法兰，让砂轮在支撑法兰上凸起的中心（导杆）处于居中位置。
- 按下主轴锁按钮，同时让六角凹陷背向砂轮，将锁定法兰 7 拧上主轴，让接片与主轴的两个插槽啮合。
- 在按下主轴锁按钮时，手动或使用随附的扳手拧紧锁定法兰 7（若状况很好，则仅使用锁定法兰。）请参阅**配件表**，查看法兰详细资料。
- 如需拆除砂轮，请按照上述流程反向操作。

### 安装砂光支撑垫 (图 G)

**注意：**使用支撑垫的砂盘（通常称为纤维树脂砂盘）不需要防护罩。由于这些配件不需要防护罩，因此防护罩在使用时可能适合，也可能不适合这些配件。

**警告：**如果未能正确放置法兰/紧固螺母/砂轮，可能会导致严重人身伤害（或者损坏工具或砂轮）。

**警告：**完成砂光应用后，必须重新安装合适的防护罩来执行研磨砂轮、切削砂轮、砂纸盘、钢丝刷和钢丝轮的应用。

- 将支撑垫 17 置于或适当固定于主轴上。
- 将砂盘 18 置于支撑垫 17 上。
- 在按下主轴锁 3 的同时，将紧固螺母 上凸出的轮毂导入砂轮盘和支撑垫的中心，从而将紧固螺母 16 旋上主轴。
- 用手拧紧紧固螺母。然后，按下主轴锁按钮并转动砂盘，直至砂盘和紧固螺母紧贴。
- 若要卸下砂轮，请抓住并转动支撑垫和砂垫，同时按下轴心锁按钮。

### 安装和拆下带轮毂的砂轮 (图 F)

带轮毂的砂轮要直接安装在螺纹主轴上。配件上的螺纹必须与主轴的螺纹相匹配。

- 将支撑法兰从工具中拉出，从而将其拆下。
- 用手将钢丝轮装到主轴 4 上。
- 按下主轴锁按钮 3 并使用扳手拧紧钢丝轮的轮毂。
- 请按上述相反的步骤操作，卸下钢丝轮。

**注意：**若启动工具前未能正确放置砂轮，可能会对工具或砂轮造成损坏。

### 安装钢丝杯刷和钢丝轮 (图 A)

**警告：**如果未能正确放置法兰/紧固螺母/砂轮，可能会导致严重人身伤害（或者损坏工具或砂轮）。

**小心：**为降低造成人身伤害的风险，请在搬运钢丝刷和钢丝轮时佩戴工作手套。钢丝刷或钢丝轮可能会变得很锋利。

**小心：**为降低造成人身伤害的风险，请在搬运钢丝刷和钢丝轮时佩戴工作手套。配件可能存在不易发现的损坏，导致钢丝从钢丝轮或钢丝杯刷配件上脱落。

将钢丝杯刷或钢丝轮直接安装在螺纹主轴上，无需使用法兰。仅使用螺纹轮毂随附的钢丝刷或钢丝轮。只需支付额外费用，就能从当地经销商或授权维修中心获取这些配件。

- 将工具放在工作台上，防护罩朝上。
- 用手将钢丝轮装到主轴上。
- 按下主轴锁按钮 3 并使用钢丝轮或钢丝刷轮毂上的扳手拧紧钢丝轮。
- 如需拆除砂轮，请按照上述流程反向操作。

**注意：**为降低工具损坏的风险，请在开启工具前正确放置轮毂。

## 使用前的准备工作

- 安装防护罩及合适的圆盘或砂轮。请勿使用过度磨损的圆盘或砂轮。
- 确保已正确安装支撑法兰与锁定法兰。遵循**配件表**中提供的说明。
- 确保圆盘或砂轮以配件和工具上的箭头方向转动。
- 请勿使用受损配件。每次使用前，请检查配件，例如检查砂轮是否碎裂，有无裂缝，检查支撑垫有无裂缝、撕裂或过度磨损，检查钢丝刷是否松动或钢丝是否断裂。如果电动工具或配件掉落，请让自己和旁观者远离转动的配件，并以用最大空载速度让工具运行一分钟。已经受损的配件一般会在此测试过程中碎裂。

## 操作

### 使用说明

**警告:** 请始终遵守安全法规以及适用规章的要求。

**警告:** 为了降低造成严重人身伤害的风险, 在进行任何调整或卸下或安装附件或配件前, 切记关掉工具的电源并取出电池包。意外启动容易造成人身伤害。

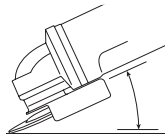

| 功能      | 角度      |
|---------|---------|
| 研磨      | 20°-30° |
| 使用砂纸盘砂光 | 5°-10°  |
| 使用支撑垫砂光 | 5°-15°  |
| 钢丝刷     | 5°-10°  |

### 将双手放在正确的位置 (图 H)

**警告:** 为了减低严重人身伤害的风险, 请务必如图示那样正确放置双手。

**警告:** 为降低造成严重人身伤害的风险, 请始终紧握工具, 防止意外事件。

正确的双手位置要求一手握住副手柄 ⑤, 一手握住辅助手柄, 如图 H 所示。

### 滑动开关 (图 A)

**小心:** 紧握工具侧手柄和主体, 以便在启动时和使用过程中保持对工具的控制, 直到砂轮或配件停止转动为止。请在确保砂轮完全停止后才放下工具。

**注意:** 若要减少工具意外移动, 不得在负载情况下启动或关闭工具。先让砂光机全速运行, 再让其接触工件表面。先将工具从工件表面提起, 然后再关闭工具。先等待工具停止转动, 再将其放下。

**警告:** 在为工具接通电源前, 先按下开关后端, 然后松开, 确保滑动开关处于“关闭”位置。在工具电源出现任何中断, 例如电池电量耗尽后, 都要确保滑动开关处于上述“关闭”位置。

如需开启工具, 要将滑动开关 ① 滑向工具前端。如需停止工具, 要松开滑动开关。

如需连续操作, 将滑动开关滑向工具前端, 并按下开关的前端。如需在连续操作模式下停止工具, 先按下滑动开关的后端, 然后再松开。

### 主轴锁 (图 I)

主轴锁 ③ 可在安装或卸下砂轮时防止主轴转动。只能在工具关闭、拔出电源插头且完全停止时使用主轴锁。

**注意:** 为降低工具损坏的风险, 不得在工具运行时使用主轴锁。否则将损坏工具, 而且安装在工具上的配件也会被迫脱, 从而导致人身伤害。

若要使用主轴锁, 请按下主轴锁按钮并转动主轴, 直到无法再转动为止。

### 表面研磨、砂光和钢丝刷

**小心:** 务必按照本手册的说明使用适当的防护罩。

若要加工工件表面:

1. 先让工具全速运转, 再将工具移至工作表面。
2. 向工作表面施加最小压力, 让工具高速运转。当工具高速运转时, 材料去除率最大。
3. 让工具与工作表面之间保持适当的角度。请根据特定功能, 参见图表。

4. 让砂轮边缘与工作表面之间保持接触。

- 若要研磨、使用砂纸盘砂光或钢丝刷, 请前后持续移动工具, 避免在工作表面上产生沟槽。
- 若要使用支撑垫进行磨削, 请沿直线移动工具, 以防止在工作表面上留下发热或转动的印记。

**注意:** 如果让工具靠在工作表面上而不移动, 就会使工件受损。

5. 先将工具从工件表面上拉起, 再关闭工具。先等待工具停止转动, 再将其放下。

**小心:** 在处理边缘时需格外小心, 因为此时砂轮机可能出现突然的大幅运动。

### 处理漆面工件时, 需要采取的预防措施

1. 不建议对含铅油漆进行钢丝刷操作, 因为难以控制污染尘埃。儿童和孕妇出现铅中毒的风险最高。
2. 在没有化学分析的情况下, 难以确定油漆是否含铅, 因此我们建议, 在对任何漆面进行研磨时, 都应采取以下预防措施。

### 人身安全

1. 在完成所有清理工作前, 儿童或孕妇不应进入正在执行漆面研磨或钢丝刷的工作区域。
2. 进入工作区域的所有人应佩戴防尘面罩或口罩。过滤器应每天或在佩戴者难以呼吸时更换。  
**注意:** 仅使用能够防护含铅油漆尘埃及气体的防尘面罩。普通油漆面罩不具备这一防护功能。请咨询当地的五金经销商, 了解经美国职业安全及卫生研究院 (NIOSH) 批准的合适口罩。
3. 不应在工作区域进食、饮水或吸烟, 以防吸入油漆污染颗粒。在进食、饮水或吸烟前, 工作人员应该先洗手和清洁。食品、饮料或烟草不应留下工作区域, 尘埃会落在它们的表面上。

### 环境安全

1. 在去除油漆时, 应将由由此产生的尘埃量减到最少。
2. 油漆的区域应使用 4 千分之一英寸厚的塑料片密封。
3. 研磨时应尽量减少工作区域外油漆粉尘的痕迹。

### 清洁和处理

1. 在研磨作业期间, 应每天对工作区域中的所有表面进行真空清扫和彻底清洁。应经常更换真空过滤器。
2. 应将滴塑布与尘埃或其他碎片一并处理。应该将它们放入密封的垃圾容器内, 并按照常规垃圾收集程序进行处理。在清理时, 儿童和孕妇应该远离工作区域。
3. 应先彻底清洗所有的玩具、可清洗的家具及儿童用具, 然后才可使用。

## 边缘研磨和切削



**警告：**请勿将边缘研磨/切削砂轮用于表面研磨，因为这些砂轮的设计无法承受表面研磨所遇到的侧压力。可能导致砂轮断裂和人身伤害。



**小心：**在使用工具时，如果用于边缘研磨和切削的砂轮出现弯曲或扭曲，就会发生碎裂或回弹。在所有边缘研磨/切削操作中，不得让防护罩的开口朝向操作人员。

**注意：**在使用 27 号砂轮进行边缘研磨/切削时，必须将其限制在浅挖和开槽的范围内——新砂轮的深度小于 13 毫米。随着砂轮磨损，其半径会缩短，切割/开槽深度也会减小。请参见**配件表**，了解详细信息。若要使用 41 号砂轮进行边缘研磨/切削，需要搭配 1 号防护罩。

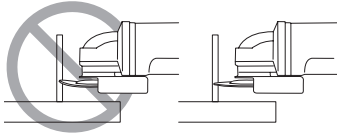

1. 先让工具全速运转，再将工具移至工作表面。
2. 向工作表面施加最小压力，让工具高速运转。当工具高速运转时，研磨/切割率最大。
3. 请勿让自己面向砂轮开口的下侧。
4. 在开始切削并在工件留下缺口后，请勿改变切削角度。改变角度会造成砂轮弯曲并可能导致砂轮断裂。边缘研磨砂轮的设计无法承受弯曲造成的侧压力。
5. 先将工具从工作表面拿开，再将其关闭。先等待工具停止转动，再将其放下。

## 金属应用

如果将该工具用于切割金属，请确保已安装剩余电流装置 (RCD)，避免因金属屑造成的剩余电流风险。

如果电源被 RCD 关闭，请将该工具送至获得授权的 DeWALT 维修代理机构。



**警告：**在极端作业环境中，导电粉尘会在加工金属时累积在机器外壳的内侧。这会导致机器中的保护性绝缘被削弱，有潜在的触电风险。

为避免机器内部累积金属屑，建议每天清洁通风槽。请参见**维护部分**。

## 金属切割

**若要在切割时使用粘合研磨剂，务必使用 1 号防护罩。**

切割时，使用适量的进料，并根据被切割材料相应调整。请勿向切割盘施压，导致机器倾斜或振荡。

请勿通过施加侧向压力的方式来降低切割盘的转速。

机器必须始终处于逆磨状态。否则，就存在机器被推出切割位置，进而失控的危险。

切割型材和方棒时，最好从最小的横截面开始切割。

## 粗磨

**不得使用切割盘来进行粗磨。**

**务必使用 27 号防护罩。**

当将机器角度设为 30° 至 40° 时，可达到最佳粗磨效果。以适中压力来回移动机器。如此，工件温度不会过高，工件不会变色且不会出现凹槽。

## 切割石材

**该机器应仅用于干切割。**

如要切割石材，最好使用金刚石切割盘。仅在佩戴了额外防尘面罩的情况下操作机器。

## 工作建议

**在结构墙上开槽时，请谨慎操作。**

在结构墙上开槽时，必须遵守特定国家/地区的规定。在所有情况下，都必须遵守这些规定。开始工作前，请咨询负责的结构工程师、建筑师或施工主管。

## 维护

您的电动工具设计精良，可以长期使用，仅需极少维护。若要连续获得令人满意的工作效果，需要您进行正确的保养和定期的清洁。



**警告：**为降低造成严重人身伤害的风险，在进行任何调整或卸下或安装附件或配件前，务必切断工具电源并取出电池包。意外启动容易造成人身伤害。

充电器和电池包不可维修。



## 润滑

本电动工具无需另行润滑。



## 清洁



**警告：**如果通风口及其周围有灰尘堆积，请用干燥的空气吹扫主机外壳，清除灰尘。进行此步骤时，请佩戴经认可的护目装备和面罩。



**警告：**不得使用溶剂或其它刺激性化学制品来清洁工具的非金属部件。这可能会削弱此类部件所有的材料。只可使用蘸有软性肥皂水的抹布进行清洁。不得让任何液体渗入工具；不得让工具的任何部件浸没在液体中。

## 可选配件



**警告：**除了 DeWALT 提供的配件之外，其他配件均未接受本工具的兼容性测试，若将此类配件与本工具一起使用将存在安全隐患。为降低人身伤害风险，本产品只可使用 DeWALT 推荐的配件。

请向您的经销商咨询更多关于合适附件的信息。

## 保护环境



分类回收。本产品 and 电池不得与普通家庭垃圾一起处理。

本产品 and 电池包含可重复使用或回收的材料，可降低对原材料的需求。请根据当地法规回收电气产品和电池。如需获得更多信息，请访问 [www.2helpU.com](http://www.2helpU.com)。

## 可充电电池包

本电池包使用寿命长，但若在进行同样的工作时，无法像以前那样提供充足电力，就必须更换电池包。在使用寿命结束时，请妥善处理，保护环境：

- 先让电池完全放电，再将其从工具上卸下。
- 锂离子电池是可回收的。请将它们送往您的代理商或当地的回收站。收集的电池包将会得到循环利用或妥善处理。

## 售后服务和维修

DeWALT 服务中心有经过培训的专门人员,可向顾客提供高效、可靠的产品服务。如果您在未获授权的服务中心进行维修,我们将不会承担任何责任。您可以查看产品包装上“客服中心位置”宣传单页,通过热线电话、网站或社交媒体与我们联系,找到距离您最近的 DeWALT 服务中心。











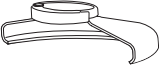

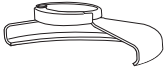

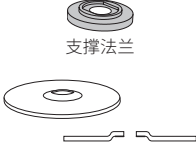
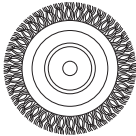

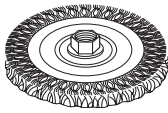
制造商:百得美国公司

地 址:701 E Joppa Rd, TW050 MD21286, Towson, 美国

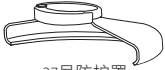

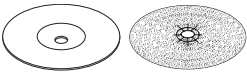





产 地:江苏苏州

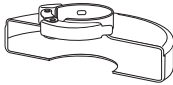

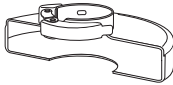
配件图

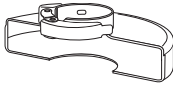
| 防护罩类型  | 配件  | 说明               | 如何安装角磨机  |
|--|---|------------------|--|
|  <p>27号防护罩</p> |    | <p>中心凹陷研磨盘</p>   |  <p>27号防护罩</p>  |
|  |    | <p>翼片砂轮</p>      |  <p>支撑法兰</p>  |
|  |    | <p>钢丝轮</p>       |  <p>27号中心凹轮</p>  <p>锁定法兰</p>   |
|  |    | <p>带螺纹螺母的钢丝轮</p> |  <p>27号防护罩</p>  <p>钢丝轮</p>   |
|  |    | <p>带螺纹螺母的钢丝杯</p> |  <p>27号防护罩</p>  <p>钢丝刷</p>  |
|  |  | <p>支撑垫/砂光板</p>   |  <p>27号防护罩</p>  <p>橡胶支撑垫</p>  <p>砂轮</p>  <p>紧固螺母</p> |

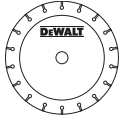
附件图表(续)

| 防护罩类型  | 配件  | 说明              | 如何安装角磨机  |
|--|---|-----------------|--|
|  <p>1号防护罩</p>  |  | <p>粘合的砖石切割盘</p> |  <p>1号防护罩</p>   |
|  |  | <p>粘合的金属切割盘</p> |  <p>支撑法兰</p>  |
|  <p>1号防护罩</p>  <p>27号防护罩</p> |  | <p>金刚石切削砂轮</p>  |  <p>切割轮</p>  <p>锁定法兰</p> |

# 無碳刷砂輪機

## DCG409

### 恭喜!

感謝您選購DEWALT工具。憑藉多年的經驗、完善的產品開發與創新，DEWALT已成為專業電動工具使用者最可靠的合作夥伴之一。請注意! 各地區上市產品/配件不盡相同，請依台灣繁體中文說明書的內容為主。

### 技術資料

|            | DCG409-TW         | DCG409-B1   | DCG409-KR   | DCG409NT-A9 |
|------------|-------------------|-------------|-------------|-------------|
| 電壓         | V <sub>DC</sub>   | 18 (20 Max) | 18 (20 Max) | 18 (20 Max) |
| 電池類型       |                   | 鋰離子         | 鋰離子         | 鋰離子         |
| 最大功率輸出     | W                 | 1647        | 1647        | 1647        |
| 額定速度       | min <sup>-1</sup> | 9000        | 9000        | 9000        |
| 砂輪直徑       | mm                | 125         | 100         | 125         |
| 砂輪厚度 (最大)  | mm                | 6           | 4           | 6           |
| 軸心直徑       |                   | M14         | M10         | M14         |
| 軸心長度       | mm                | 21.5        | 16          | 21.5        |
| 重量 (不包括電池) | kg                | 1.81        | 1.62        | 1.73        |

該信息表中的振動和/或噪音排放水平已經按照EN60745中給出的標準化測試進行測量，可用來將兩款工具做對比。它可被用於對暴露情況進行初步測試。

**警告:** 宣稱的振動和/或噪音釋放水準所代表的是工具主要應用所發出的振動和/或噪音。然而，如果將工具用於不同應用，搭配不同附件或保養不當，那麼振動和/或噪音的情況就會有所不同。這可能會在整個工作期間大幅提升振動和/或噪音的暴露水準。  
當工具關閉或在空轉時，還應預估振動和/或噪音暴露水

準。這可能會在整個工作期間大幅降低振動和/或噪音的暴露水準。

確認額外的安全措施，保護操作人員免受振動和/或噪音的影響，例如：保養工具和附件，保持雙手溫暖（與振動有關），工作形式的組織安排。



**警告:** 為了降低受傷的風險，必須仔細閱讀使用手冊。

### 定義: 安全指南

以下定義描述了每一個詞彙的嚴重程度。請閱讀本手冊並注意這些符號。



**危險:** 表示緊急危險狀況，若未能避免，將導致**死亡**或**嚴重傷害**。



**警告:** 表示潛在危險情況，若未能避免，可能導致**死亡**或**嚴重傷害**。



**小心:** 表示潛在危險情況，若未能避免，可能導致**輕微**或**中度傷害**。



**注意:** 表示一種**非人身傷害**的行為，若未能避免，可能導致**財產損失**。



表示**觸電**危險。



表示**火災**危險。

| 電池     |                   |          |        | 充電器/充電時間 (分鐘) |        |         |         |
|--------|-------------------|----------|--------|---------------|--------|---------|---------|
| 目錄號    | 伏特                | 安時       | 重量(kg) | DCB107        | DCB115 | DCB118  | DCB1112 |
| DCB606 | 18/54 (20/60 Max) | 6.0/2.0  | 1.05   | 270           | 90     | 60      | 40      |
| DCB609 | 18/54 (20/60 Max) | 9.0/3.0  | 1.46   | 420           | 135*   | 75*     | 60      |
| DCB612 | 18/54 (20/60 Max) | 12.0/4.0 | 1.44   | 540           | 180    | 120     | 80      |
| DCB203 | 18 (20 Max)       | 2.0      | 0.40   | 90            | 30     | 30      | 30      |
| DCB205 | 18 (20 Max)       | 5.0      | 0.62   | 240           | 75     | 75/50** | 75/50** |
| DCB240 | 18 (20 Max)       | 4.0      | 0.54   | 185           | 60     | 60      | 60      |

\*日期碼201811475B或以後

\*\*日期碼201536或以後

20V Max為最大初始電壓，標稱電壓為18V。60V Max為最大初始電壓，標稱電壓為54V。

## 電動工具一般安全警告



**警告！請閱讀安全警告及所有指示。**不遵循下列的這些警告和指示可能會導致觸電、火災及/或嚴重傷害。

**請保存所有警告與指示以備將來查閱。**

以下列示所有警告中的術語「電動工具」是指電源驅動(插電)電動工具或電池驅動(充電)電動工具。

### 1) 工作場地安全

- 請保持工作場地清潔明亮。混亂或黑暗的場地會引發事故。
- 請勿在易爆環境，如有易燃液體、氣體或粉塵的環境中操作電動工具。電動工具產生的火花可能會引燃粉塵或煙霧。
- 請等待兒童和旁觀者離開之後才操縱電動工具。分心會導致您疏於控制。

### 2) 電氣安全

- 電動工具插頭必須與插座相符。切勿以任何方式改裝插頭。需接地的電動工具不能使用任何配接器插頭。使用未經改裝的插頭與相符的插座可降低觸電風險。
- 避免人體接觸接地表面，如管道、散熱片、爐灶和冰箱。若您的身體接地，會提高觸電的風險。
- 不得將電動工具暴露在雨中或潮濕環境中。水進入電動工具會提高觸電風險。
- 切勿濫用電線。請勿使用電線來搬運、拉動電動工具或拔出插頭。讓電線遠離熱、油、銳邊和活動部件。受損或纏繞的電線會增加觸電危險。
- 若要在戶外使用電動工具，請使用適合戶外使用的延長電線。採用適合室外使用的電線可降低觸電危險。
- 若必須在潮濕環境中操作電動工具，請使用受漏電保護器(RCD)保護的電源供應器。使用RCD可降低觸電風險。

### 3) 人身安全

- 保持警覺；在操作電動工具時，請留意所執行的操作並按照一般的程式執行。請勿在疲倦或在受到毒品、酒精或藥品的影響時使用電動工具。操作電動工具時，一時的注意力分散可能會導致嚴重人身傷害。
- 使用個人防護裝置。始終佩戴護目裝置。防護設備(例如在適當條件下使用的防塵面具、防滑安全鞋、安全帽或聽力保護裝置)可減少人身傷害。
- 避免意外啟動。連接電源及/或電池組、舉抬或搬運電動工具之前，請確定開關處於關閉位置。若搬運電動工具時將手指放在開關上，或者在電動工具開關開啟時將插頭插入電源插座，這兩種行為都會引發事故。
- 啟動電動工具之前，請卸下所有的調整鑰匙或扳手。遺留在電動工具旋轉部件上的扳手或鑰匙會導致人身傷害。
- 不要過度伸張雙手。時刻注意腳下與身體的平衡。如此可在意外情況下更好地控制電動工具。
- 適當穿著。請勿穿寬鬆衣服或佩戴飾品。讓您的頭髮、衣服和手套遠離活動部件。寬鬆衣服、飾物或長髮可能會捲入活動部件中。
- 若配備用於連接排屑裝置、集塵設備的裝置，請確定正確連接和使用這些裝置。使用集塵設備可減少與粉塵有關的危險。
- 請勿因頻繁使用而對工具特別熟悉，讓你變得自滿而忽略工具的安全原則。粗心操作可以在片刻間造成嚴重傷害。

### 4) 電動工具的使用與注意事項

- 請勿超負荷使用電動工具。請根據您的應用使用正確的電動工具。若使用的電動工具正確無誤，該工具能以設計額定值更有效、更安全地執行工作。
- 若開關不能開啟或關閉電源，切勿使用該電動工具。若開關無法控制電動工具，則電動工具存在危險，必須予以維修。
- 在執行任何調整、更換配件或儲存工具之前，必須從電源上拔掉插頭及/或卸下電池組。此類防護性安全措施可降低電動工具意外啟動的風險。
- 將閒置的電動工具儲存在兒童無法接觸的地方，並且不要讓不熟悉電動工具或對這些使用指示不瞭解的人員操作電動工具。未經訓練的使用者操作電動工具會發生危險。
- 維護電動工具。檢查活動部件是否對準或卡住、是否存在任何破損情況，或任何能影響電動工具運行的其他情況。若有損毀，必須在使用之前修理電動工具。許多事故都是由於電動工具欠缺維護所導致。
- 保持切割工具鋒利和清潔。妥善維護、刀刃鋒利的刀具卡住的可能性更低，更易於控制。
- 使用電動工具、配件和工具刀頭等時，請遵循這些指示使用，且指示須包含工作環境和所要執行工作的注意事項。若使用電動工具執行與設計用途不相符的操作，會導致危險。
- 手柄和抓握表面都應保持乾燥、清潔及遠離油脂。光滑手柄和抓握表面不便於在意外情況下對工具進行安全處理與控制。

### 5) 電池工具的使用與注意事項

- 只能使用製造廠商指定的充電器為電池充電。使用僅適合一種電池組的充電器為其他類型的電池組充電會導致火災危險。
- 請使用原廠的電動工具電池組。使用其他非原廠的電池組會導致人身傷害和火災危險。
- 不使用電池組時，請將其遠離迴紋針、硬幣、鑰匙、釘子、螺絲以及其他可連通電池兩極的金屬物品。將電池兩極短路會導致灼傷或火災。
- 濫用電池的情況下，液體會從電池中噴出；避免與液體接觸。若不小心接觸液體，請用清水沖洗。若液體噴濺到眼睛上，沖洗之後還要進行治療。從電池噴出的液體會刺激皮膚或造成灼傷。
- 請勿使用已經損壞或改動的電池組或工具。損壞或改動的電池可能表現出不可預計的行為，導致火災、爆炸或傷害風險。
- 請勿讓電池組或工具暴露於火中或過高溫度的環境中。暴露於火中或溫度超過 130°C 的環境中可能導致爆炸。
- 請遵循所有充電說明，請勿在說明中規定的溫度範圍以外的環境對電池組或工具充電。不當或在指定範圍以外的溫度下充電，可能導致電池損壞並增加火災風險。

### 6) 檢修

- 本電動工具必須由合格的維修人員並只採用相同的原廠零件來執行檢修。這將確保電動工具的安全性。
- 切勿維修損毀的電池組。電池組的維修應僅由製造商或授權服務提供商執行。

## 其他特殊安全規定

### 所有操作之安全指示

- 本電動工具設計用作打磨機、砂光機、鋼絲刷或切割工具。請閱讀本電動工具隨附的所有安全警告、指示、圖示和規格。**不遵循下列的所有指示可能會導致觸電、火災及/或嚴重傷害。
- 不建議使用本電動工具執行拋光等操作。**將電動工具用於非專用的操作會引發危險並導致人身傷害。
- 請勿使用非工具製造廠商專門設計及推薦的配件。**就算配件可裝到電動工具上，這並不代表它能確保安全操作。
- 配件的額定速度必須至少等於電動工具上所標的最大速度。**配件以比其額定速度大的速度運行可能會引發爆裂和飛濺。
- 配件的外徑與厚度必須在電動工具的額定範圍內。**錯誤尺寸的配件將無法得到充分保護或控制。
- 配件的螺紋安裝必須與砂輪機軸心螺紋相配。**對於透過凸緣安裝的配件，配件的軸孔必須適合凸緣的定位直徑。與電動工具安裝件不相配的配件將會失衡、過度震動並會引起失控。
- 請勿使用受損配件。**每次使用前，請檢查配件，例如檢查砂輪是否有碎裂和裂縫，檢查支撐墊是否有裂縫、撕裂或過度磨損，檢查鋼絲刷是否鬆動或鋼絲是否斷裂。若電動工具或配件跌落，請檢查是否損毀，或立即安裝未破損的配件。檢查並安裝配件後，讓自己和旁觀者遠離配件的旋轉範圍，並讓電動工具以最大的空載速度運行一分鐘。受損配件一般會在此測試過程中碎裂。
- 佩戴個人防護裝置。**根據適用情況，使用面罩、安全護目鏡或防護眼鏡。若適用，請佩戴防塵面具、聽力保護器、手套及能阻擋細小磨料或工件碎片的工作圍裙。護目裝備必須能夠擋住各種操作所產生的飛屑。防塵面具或口罩必須能夠過濾各種操作所產生的顆粒。長期暴露於高強度噪音中可能會使聽力受損。
- 讓旁觀者與工作場地保持一定安全距離。**任何進入工作場地的人員都必須佩戴個人防護裝置。工件或受損配件的碎片可能會飛出並導致緊靠著操作區域的旁觀者受到傷害。
- 若在執行操作時鋸切工具可能會接觸隱藏的電線，請僅從絕緣手柄表面握住電動工具。**若接觸到「帶電」導線，工具金屬部件表面就會「帶電」，從而導致操作人員觸電。
- 直到配件完全停止運動才放下電動工具。**旋轉的配件可能會抓住表面並拉動電動工具，讓您失去對工具的控制。
- 攜帶電動工具時不要啟動它。**意外接觸旋轉配件可能會纏繞您的衣服，使配件傷害您的身體。
- 定期清理電動工具的通風口。**電動機風扇會將灰塵吸進機殼，過多的金屬粉塵沉積可能會導致電氣危險。
- 請勿在易燃材料附近操作電動工具。**火星可能會點燃這些材料。
- 請勿使用需要冷卻液的配件。**用水或其他冷卻液可能會導致觸電或觸電致死。
- 請勿在該工具上使用11類(杯形砂輪)砂輪。**使用不當配件會導致受傷。
- 務必使用副手柄。擰緊把手。**請始終使用副手柄來保持對工具的掌控。

**警告：**我們推薦使用額定電流為30毫安培或以下的剩餘電流裝置。

## 所有操作之進一步安全指示

### 反衝的原因及操作人員可採用的預防措施

反衝是因卡住或纏繞住的旋轉砂輪、支撐墊、鋼絲刷或任何其他配件而產生的突然反作用力。卡住或纏繞會引起旋轉配件迅速失速，隨之使失控的電動工具在卡住點產生與配件旋轉方向相反的運動。例如，若除漆盤被工件纏繞或卡住，伸入卡住點的除漆盤邊緣可能會進入材料表面，從而引起除漆盤爬出或反衝。除漆盤可能會飛向或飛離操作人員，這取決於除漆盤在卡住點的運動方向。在此條件下，砂輪也可能會碎裂。

反衝是由於電動工具使用不當及/或不正確的操作程序或條件而導致。可透過採取下列適當的預防措施而避免：

- 保持緊握電動工具，調整身體和手臂位置，以應對反衝。如有輔助手柄，則要一直使用，以最大限度地控制啟動時的反衝力或反扭矩。**若採取合適的預防措施，操作人員即可以控制反扭矩或反衝力。
- 切勿將手靠近旋轉配件。**配件可能會反衝碰到手。
- 請勿站在發生反衝時電動工具可能移動到的位置。**反衝將在纏繞點促使工具逆砂輪運動方向運動。
- 處理尖角、銳邊等時請格外小心。**避免附件跳彈和被纏繞住。尖角、銳邊或彈跳可能會繼續旋轉配件並引起失控或反衝。
- 請勿附裝上鋸鏈、木膠片或帶齒鋸片。**此類鋸片會產生頻繁的反衝和失控。

### 針對打磨和砂輪切割操作的安全警告

- 只使用為電動工具所推薦的砂輪型號及為所選砂輪專門設計的防護罩。**不是專為電動工具設計的砂輪無法得到充分保護，而且不安全。
- 中心凹陷的砂輪的打磨表面必須安裝在防護罩邊緣平面的下方。**安裝不當且穿過防護罩邊緣平面的砂輪無法得到充分保護。
- 防護罩必須牢固地裝在電動工具上，且放置在最安全的地方，**以便讓最小的砂輪部分暴露在操作人員面前。防護罩有助於保護操作人員免受受到爆裂砂輪碎片，意外觸及砂輪與可燃衣物之火花之危險。
- 砂輪只可用於推薦的用途。**例如，不要使用切割砂輪的側面進行打磨。切割砂輪設計用於圓周打磨，施加到砂輪側面的力可能會使其碎裂。
- 始終為所選砂輪選用未損毀、尺寸及形狀正確的砂輪凸緣。**合適的砂輪凸緣可支撐砂輪，從而可以減少砂輪破裂的可能性。切割砂輪的凸緣可能與打磨砂輪的凸緣不同。
- 請勿使用大規格電動工具上剩餘的磨損砂輪。**用於大規格電動工具的砂輪不適於較小規格工具的高速工況並可能會爆裂。

### 針對砂輪切割操作的附加安全警告

- 切勿「夾」住切割砂輪或施加過大的壓力。**請勿試圖進行過深的切割。給砂輪施加過高的應力將增加砂輪在切削時的負載，容易纏繞或卡住，而且將增加反衝或砂輪爆裂的可能性。
- 身體不要與旋轉砂輪呈一條直線，也不要站在其後。**將在操作點的砂輪從操作人員身邊移開時，可能的反衝可能會使旋轉砂輪和電動工具朝向您推動。
- 砂輪被卡住或無論因任何原因而中斷切割時，關掉電動工具並握住工具不動，直到砂輪完全停止。**切勿試圖在砂輪仍

然運行時使切割砂輪脫離切割，否則可能會發生反衝。檢查並採取矯正措施，以消除砂輪卡住的原因。

- d) 請勿在工件上重新啟動切削操作。讓砂輪達到全速後再小心地重新進入切割。若電動工具在工件中重新啟動，砂輪可能會卡住、爬出或反衝。
- e) 支撐住板材或任何超大工件以最大限度地降低砂輪卡住和反衝的風險。大型工件由於自身重量而有下陷的傾向。必須在工件靠近切線處及砂輪兩側近工件邊緣處放置支撐物。
- f) 對現有牆體或其他盲區進行「盲切割」時應格外小心。伸出的砂輪可能會割到氣管、水管、電線或由此引起反衝的物體。

## 針對砂光操作的安全警告

- a) 切勿使用尺寸過大的砂盤紙。請遵循製造廠商的建議選用砂紙。伸出砂盤的大規格砂紙會構成割傷危害並可能會導致切盤纏繞、撕裂或反衝。

## 針對刷光操作的安全警告

- a) 請注意，即使在正常操作期間，鋼絲刷也會掉落鋼絲。請勿對鋼絲刷施加過量負載，以免對鋼絲施加過應力。鋼絲刷可輕鬆地刺穿單薄的衣服及/或皮膚。
- b) 若建議使用防護罩進行刷光，則不允許鋼絲輪或鋼絲刷對防護罩進行干擾。鋼絲輪或鋼絲刷的直徑可能會因為工作和地心引力而擴展。

## 剩餘風險

即使應用有關的安全規定並採用安全設備，仍然還有一些無法避免的剩餘風險。危險包括：

- 聽力受損。
- 飛散的顆粒引起的人身傷害風險。
- 操作過程中配件變熱引起的灼傷風險。
- 長時間使用引起的人身傷害風險。
- 危害物質粉塵引起的風險。

## 充電器

DeWALT 充電器無需調節，專為盡可能輕鬆使用而設計。

### 電氣安全

電動馬達只適用一種電壓。請務必檢查電池組電壓是否與銘牌一致，並且確保充電器的電壓與電源電壓一致。



DeWALT 充電器符合 IEC60335 雙重絕緣要求，因此無需使用接地線。

如果電源線損壞，必須由 DeWALT 或授權的維修機構負責更換。

### 使用延長電纜

如非絕對必要，否則不要使用延長電纜。請使用與充電器的輸入功率相配的認可延長電纜（請參閱技術資料）。導體體的最小橫截面尺寸為 1 平方公釐，最長為 30 米。

使用電纜捲筒時，每次必須把電纜完全展開。

### 所有電池充電器之重要安全指示

請妥善保管好這些說明：本手冊包含重要的相容電池充電器安全和操作說明（請參閱技術資料）。

- 在使用充電器之前，請先閱讀所有指示以及充電器、電池組和使用電池組的產品上的警告標記。



**警告：**觸電危險。切勿讓任何液體進入充電器，否則可能會導致觸電。



**警告：**建議使用漏電流額定值不超過 30mA 的漏電流保護裝置。



**小心：**燒傷危險。為了減低受傷風險，只可以使用 DeWALT 可充電電池。其他非原廠電池可能會爆裂，導致人身傷害和損害。



**小心：**必須監督兒童，確保他們沒有耍玩器具。

**注意：**在某些情況下，充電器連接到電源後，充電器內暴露的充電觸頭會被異物導致短路。導電的異物，包括但不限於鋼絲絨、鋁箔紙或任何由金屬粒子組成的物件，必須要遠離充電器範圍。充電器裡沒有電池組時，一定要拔掉充電器的電源。請先拔掉電源插頭後再清潔充電器。

- 請勿嘗試使用本手冊未提到的充電器為電池組充電。充電器和電池組是專為搭配使用而特別設計。
- 除了為 DeWALT 可充電電池充電之外，這些充電器不可以用於其他用途。否則可能會導致火災、觸電或觸電致死。
- 請勿將充電器暴露在雨或雪中。
- 中斷充電器的電源時，請拔除插頭而非拉扯電線。這樣會減低電源插頭和電線損壞的風險。
- 請確保電線的位置不會遭踐踏、令人絆倒或容易受到其他方式的損壞或受壓。
- 除非絕對需要，否則請勿使用延長電線。使用不適當的延長電線會引起火災、觸電或觸電致死。
- 請勿將任何物件放在充電器上面，或是把充電器放在可能會堵住通風槽的柔軟表面，導致充電器的內部過熱。請將充電器放到遠離熱源的位置。充電器透過外殼頂部及底部的槽散熱。
- 請勿操作電線或插頭損壞的充電器，請立即予以更換。
- 如果充電器受到重擊、墜落或出現其他損壞情況，請勿使用充電器，並應拿到授權維修中心修理。
- 請勿自行拆卸充電器。需要維護或修理時，請拿到授權維修中心。重新組裝不當可能會導致觸電、觸電致死或火災。
- 若電源線損毀，必須由製造商、服務代理或同等資質的人員立即更換以避免發生危險。
- 在清潔之前，請將充電器的插頭從電源插座上拔掉，這樣可以減低觸電風險。拆除電池組並不能夠降低這種風險。切勿試圖將 2 個充電器連接在一起。
- 充電器是為標準 110 伏特的家用電源而設計。請勿試圖使用其他電壓。本規定不適用於車載充電器。

### 為電池充電 (圖 B)

1. 放入電池組前，先將充電器的插頭插入適當的插座。
2. 將電池組 **10** 放進充電器，確保電池組已完全放入。紅燈（充電中）會不斷閃爍，這表示充電程序已經開始。
3. 當紅燈持續亮起時，代表充電完成。此時，電池組的電力全滿，可以立即使用或是留在充電器裡。要從充電器上取下電池組，請按下電池組上的電池釋放按鈕 **11**。

**注意：**為了確保鋰離子電池組的效能及使用壽命最大化，在第一次使用電池組之前必須完全充電。

### 充電器操作

如需瞭解電池組的充電狀態，請參閱以下指示燈。

充電狀態指示燈



充電中



## 充電狀態指示燈



已完全充電



電池組熱/冷延遲\*

\*紅燈會繼續閃爍，但在執行此操作期間黃色指示燈將亮起。電池組達到適當溫度後，黃色指示燈將熄滅，充電器將恢復充電程序。相容的充電器不會為有故障的電池組充電。充電器會透過不亮燈來表示電池組故障。

相容的充電器不會為有故障的電池組充電。充電器會透過不亮燈來表示電池組故障。

註：亦有可能是充電器發生故障。

如果充電器指示故障，請將充電器和電池組拿到授權維修中心進行測試。

## 電池組熱/冷延遲

若充電器偵測到電池組過熱或過冷，會自動啟動電池組熱/冷延遲，在電池組達到適合的溫度之前暫停充電。然後，充電器會自動轉換到電池組充電模式。此功能可確保電池組的使用壽命最大化。

冷電池組的充電速度大約是暖電池組的一半。在整個充電週期，電池組會以較慢的充電速度進行充電，即使電池組變暖，充電速度亦不會回復至最大充電速度。

## 電子保護系統

XR 鋰離子工具的設計具有電子保護系統，可保護電池組，避免過載、過熱或深度放電。

如果電子保護系統啟動，本工具會自動關閉。如果出現此情況，請將鋰離子電池組放進充電器直到電力全滿。

## 牆面安裝

這些充電器經過精心設計，可以安裝在牆面上或立在工作臺或工作表面上。若採用牆面安裝，請將充電器安裝在電源插座連接範圍內的位置，並遠離角落或可能阻礙空氣流動的障礙。將充電器的背面用作在牆面上確定安裝螺絲位置的型板。使用長度至少 25.4 公釐、螺頭直徑為 7-9 公釐的牆用螺絲(另售)牢固安裝充電器，旋進木料的最佳深度為螺絲大約有 5.5 公釐長度露在木料外。將露出的螺絲與充電器背面的槽對齊，並完全接合到槽中。

## 充電器清潔指示



**警告：觸電危險。**在清潔之前，請將充電器的插頭從電源插座上拔掉。使用軟布或非金屬軟刷，去除充電器外部的污垢和油脂。切勿讓任何液體滲入工具，切勿讓工具的任何部件浸在液體中。

## 電池組

## 所有電池組之重要安全指示

在訂購更換電池組時，請務必附上目錄型號和電壓。

包裝箱內的電池組並未完全充電。使用電池組和充電器之前，請閱讀下列安全指示，然後遵循所述的充電程式。

## 請閱讀所有指示

- 不要在易爆環境，如有易燃液體、氣體或粉塵的環境中進行充電或使用電池組。將電池組放進充電器或從充電器中取出電池組可能會點燃粉塵或氣體。
- 切勿強行將電池組放進充電器。請勿以任何方式改裝電池組以在不相容的充電器中使用，否則電池組可能會破裂，導致嚴重人身傷害。
- 請僅使用指定的 DeWALT 充電器為電池充電。

- 請勿將水分或其他液體飛濺到電池組或將電池組浸沒。
- 請勿在溫度可能低於 4 °C (39.2 °F) 如冬天戶外的棚子或金屬建築物中，或在溫度可能達到或超過 40 °C (104 °F) 的地方(如夏天戶外的棚子或金屬建築物中)存儲或使用工具和電池包。
- 即使電池組已嚴重損毀或磨損，也請勿焚燒電池組。電池組可能會在火中爆炸。焚燒鋰離子電池組時會產生有毒氣體和物料。
- 若電池液體接觸到皮膚，請立即以中性肥皂與清水沖洗接觸範圍。若電池液體進入眼睛，請睜開眼睛，用清水沖洗 15 分鐘或直到不適感消失為止。如果需要接受治療，電池的電解質由液化有機碳酸鹽和鋰鹽構成。
- 開啟的電池中的物質可能會導致刺激呼吸道。請轉移至空氣流通處。如果症狀持續，請尋求醫療救助。



**警告：灼燒危險。**電池液如遇到火花或火焰可能會引起燃燒。



**警告：**不論是因為任何理由，都不要嘗試打開電池。如果電池組的外殼破裂或損毀，請勿放進充電器。切勿撞擊、摔落或損毀電池組。切勿使用受到重擊、墜落或出現其他損壞情況的電池組或充電器(例如釘子刺穿、以錘子敲打或踐踏)。否則可能會引起觸電或觸電致死。損毀的電池組應該送回維修中心進行回收。



**警告：火災危險。**請勿在儲存或搬運電池組時讓金屬物件接觸暴露的電池兩極。例如，不要將電池組放在帶有鬆動的釘子、螺絲、鑰匙等的地方。



**小心：不使用工具時，請將工具平放在沒有絆倒或跌落危險的穩定平面上。**一些具有大型電池組的工具可以直立但可能會輕易被撞倒。

## 運輸



**警告：火災危險。**搬運電池時若電池兩極意外接觸導電材料。運輸個別電池組時，請確保電池兩極受到保護並與可能接觸兩級並導致短路的材料隔絕。

註：鋰離子電池不應放在託運行李中。

DeWALT 電池符合行業和法律標準(包括聯合國危險貨物運輸建議書、國際航空運輸協會(IATA)危險物品處理規則、國際海運危險物品(IMDG)處理規則以及國際公路運送危險物品歐洲協議(ADR))規定的所有適用運輸規章。鋰離子電池和電池組均已根據《聯合國危險貨物運輸建議書測試與標準手冊》第 38.3 節的規定進行測試。

大多數情況下，不會將運輸 DeWALT 電池組分歸為完全管制的第 9 類危險品。一般只有在運輸中包含額定能量大於 100 瓦時(Wh)的鋰離子電池時，才會將其分歸為完全管制的第 9 類危險品。所有鋰離子電池外殼上均標註有瓦時等級。此外，由於規章的複雜性，DeWALT 不建議對鋰離子電池組單獨採用空運，不論其額定能量是多少瓦時，都是如此。若電池組的額定能量不超過 100 瓦時，可以同時空運工具與電池組(組合套件)。

無論運輸是否納入完全管制範圍內，運輸方均有責任諮詢瞭解針對包裝、標籤/標記及單據要求的最新規定。手冊本節資訊基於良好商譽原則提供，在編製文件時被視為準確無誤，但不提供任何明示或暗示的保證。買方負有確保其行為遵守適用法規的責任。

## 運輸 FLEXVOLT™ 電池

DeWALT FLEXVOLT™ 電池有兩種模式：**使用與運輸。**

**使用模式：**若 FLEXVOLT™ 電池單獨使用或在 DeWALT 18 伏特(最大 20 伏特)產品中使用時，將作為 18 伏特(最大 20 伏特)特電池運作。若 FLEXVOLT™ 電池在 54 伏特(最大 60 伏特)或 108 伏特(最大 120 伏特)(兩個 54 伏特(最大 60 伏特)電池)產品中使用，將作為 54 伏特(最大 60 伏特)電池運作。

**運輸模式:** FLEXVOLT® 電池附加護蓋時，電池將處於運輸模式。

若將電池組內的一連串電池中斷電氣連接，會導致 3 個電池各自的瓦時 (Wh) 額定值低於 1 個電池的瓦時額定值。這樣電池數量雖然增加到 3 個，但瓦時額定值更低，因此能避開針對較高瓦時電池的運輸規章。

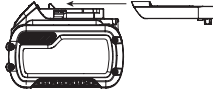

例如，若運輸瓦時額定值為 3 x 36 瓦時，表示運輸 3 個電池，每個電池的額定值為 36 瓦時。使用瓦時額定值可能為 108 瓦時 (表示 1 個電池)。

使用和運輸的標籤範例



## 儲存建議

1. 乾燥、涼爽、太陽不會直接照射、不會過熱或過冷的地方是電池組的最佳存放地點。為達到最大效能和使用壽命，不使用電池時請以室溫儲存電池組。
2. 如需長期儲存，建議將電力全滿的電池組從充電器卸下，儲存於涼爽、乾燥處，使電池組效能達到最佳。

**注意:** 電池組不應在電力耗盡的情況下儲存。在使用之前，電池組必須再次充電。

## 充電器和電池組上的標籤

除了本手冊的圖示之外，充電器及電池組上的標籤包含以下圖示：



使用前請閱讀使用手冊。



充電時間請見**技術資料**。



切勿插入導體。



切勿為損毀的電池組充電。



切勿暴露在水中。



立即更換損壞的電線。



只在溫度介於 4°C 至 40°C 之間充電。



僅供室內使用



棄置電池組時要顧及環保。



只使用指定的 DeWALT 充電器為 DeWALT 電池組充電。使用 DeWALT 充電器對指定的 DeWALT 電池以外的電池組充電會爆裂或導致其他危險情形。



切勿焚化電池組。



使用 (無運輸電池蓋)。範例: 瓦時額定值為 108 瓦時 (具有 108 瓦時的 1 個電池)。



運輸 (有內建運輸電池蓋)。範例: 瓦時額定值為 3 x 36 瓦時 (具有 36 瓦時的 3 個電池)。

## 電池類型

以下工具的運行需要一個 18 (20 Max) 伏電池組: DCG409

這些電池組可用於: DCB203, DCB205, DCB240, DCB606, DCB609, DCB612。更多資訊請見**技術資料**。

## 套裝內的物件

本套裝包括:

- 1 砂輪機
- 1 125 公釐防護罩 (類型 27)
- 1 側手柄
- 1 法蘭組
- 1 六角扳手
- 1 鋰電池組 (C1, D1, L1, M1, P1, S1, T1, X1, Y1 型號)
- 2 鋰電池組 (C2, D2, L2, M2, P2, S2, T2, X2, Y2 型號)
- 3 鋰電池組 (C3, D3, L3, M3, P3, S3, T3, X3, Y3 型號)
- 1 使用手冊

**注意:** 電池組、充電器和工具箱沒有隨 N 型號附送。電池組和充電器沒有隨 NT 型號附送。B 型號包括 Bluetooth® 電池組。

**注意:** Bluetooth® 標誌和徽標是註冊商標，歸 Bluetooth®, SIG, Inc. 所有，而且 DeWALT 對該標誌的任何使用均獲得許可。其他商標和商標名均歸各自所有者所有。

- 檢查集塵器、部件或附件是否在運輸過程中損壞。
- 操作前，請抽空仔細閱讀並掌握本手冊。

## 工具上的標誌

工具上會附帶下列圖示：



使用前請閱讀使用手冊。



請佩戴聽力保護器。



請佩戴護目鏡。

## 日期代碼位置 (圖 E)

日期代碼 **12** 包括製造年份，已經印刷在工具外殼上。

範例:

2021 XX XX

製造的年份和週

## 說明 (圖 A)



**警告:** 請勿改動本電動工具或其任何部件，否則可能導致損壞或人身傷害。

- 1 滑塊開關
- 2 鎖定桿
- 3 軸心鎖按鈕
- 4 軸心
- 5 支撐法蘭



- 6 支撐凸緣
- 7 鎖定凸緣
- 8 防護罩
- 9 防護罩釋放桿
- 10 電池組
- 11 電池釋放按鈕

## 設計用途

您的 DCG409 砂輪機為專業鋸切木材、金屬和管線而設計。

**請勿**在潮濕有水或者存在易燃液體或氣體的環境下使用。

此砂輪機是專業的電動工具。

**請勿**讓兒童接觸此工具。缺乏經驗的操作人員需要在監督下使用本工具。

- **幼童和體弱者。**幼童和體弱者不適合在無監督下使用本工具。
- 體力、感覺或智力不足，以及缺乏經驗、知識或技能的人員（包括兒童）不適合使用本產品，除非一旁有能為他們安全負責的監督人員。請勿讓兒童單獨接觸本工具。

## 特色

### 零電壓關閉

如果斷電，零電壓功能可以在開關未迴圈的情況下停止研磨機的重新啟動。

### 電子離合器

該設備配有 E-Clutch™（電子離合器）。如果出現高載荷或砂輪被夾住的情況，該設備將被關閉，降低對用戶的反作用力矩。需要迴圈開關（打開和關閉）才能重啟工具。

### Kickback Brake™

當探測到出現被夾住、失速或被綁定情況時，電子制動裝置就會全力介入，迅速停止砂輪，減少研磨機的移動並將其關閉。需要先鬆開開關，再按下開關，從而重啟工具。

### Power-OFF™ 載保護

如果電機超載，就會減少對電機的供電。如果電機持續超載，工具將被關閉。需要先鬆開開關，再按下開關，從而重啟工具。每當電流載荷達到超載電流值（電機燃燒點），工具就會斷電。如果持續出現超載關斷的情況，請減輕施加在工具上的力量/重量，直到工具可在沒有過載的情況運行為止。

### 緩啟動裝置

緩啟動裝置讓工具能夠逐漸加速，避免在啟動時出現初始衝擊。當在封閉空間作業時，該特色功能尤為有效。

### 抗振側手柄

抗振側手柄能夠吸收工具產生的振動，讓您在握持時更舒適。

## 裝配與調整



**警告：**為了減低造成嚴重人身傷害的風險，在進行任何調整或取出/安裝附件或配件之前，請關閉裝置。意外啟動工具可能會造成傷害。



**警告：**請僅使用 DeWALT 電池組與充電器。

## 插入或取出工具上的電池組 (圖 B)

**注意：**請確保您的電池組 10 已完全充電。

## 將電池組安裝到工具手柄中

1. 將電池組 10 對齊集塵器內的軌道 (圖 B)。
2. 將電池組滑入軌道內，使其牢牢地固定在工具內，並確保您聽到其鎖定到位的聲音。

## 從工具中取出電池組

1. 按下釋放按鈕 11。將電池組從工具手柄中穩妥地拉出。
2. 按本手冊充電器部分所述將電池組插入充電器中。

## 電量計電池組 (圖 C)

一些 DeWALT 電池組帶有包含三個綠色 LED 燈的電量計，可以指示電池組的剩餘電量。

若要啟用電量計 19，請按下並按住電量計按鈕，三個綠色 LED 燈將以組合方式亮起，以指示剩餘電量。電池電量低於可用限值時，電量計不會亮起，此時需要對電池充電。

**注意：**電量計只指示電池組的剩餘電量。它並不指示工具功能，且根據工具組件、溫度和最終使用者的應用而有所不同。

## 安裝側手柄 (圖 C)



**警告：**使用工具之前，請檢查手柄是否牢固擰緊。

將側手柄 5 牢固地旋入齒輪箱任一側的其中一個孔中。務必使用側手柄，以始終保持對工具的控制。

## 旋轉齒輪箱 (圖 D)

為提升舒適度，齒輪箱將轉動 90° 以便進行切割操作。

1. 移除用於安裝齒輪箱到電動機外殼上的四個角螺絲。
2. 無需將齒輪箱與電動機外殼分開，將齒輪箱頭端旋轉到所需位置。

**注意：**如果齒輪箱與電動機外殼分開距離超出 3.17 公釐，則必須將本工具交由授權的 DeWALT 維修中心維修和重新組裝。若不維修本工具，可能導致電動機與軸承發生故障。

3. 重新安裝螺絲以將齒輪箱安裝到電動機外殼。將螺絲以 12.5 in.-lbs 的扭矩擰緊。過分扭緊會導致螺絲損壞。

## 防護罩



**小心：**防護罩必須與所有打磨砂輪、切削砂輪、砂紙盤、鋼絲刷及鋼絲輪一同使用。本工具僅在使用常規砂盤砂光時可以不使用防護罩。請參閱圖 A，瞭解裝置隨附的防護罩。某些應用可能需要從本地經銷商或經過授權的服務中心購買適當的防護罩。

**注意：**邊緣打磨與切削可採用專為此用途設計並指定的 27 號砂輪進行；6.35 公釐厚的砂輪用於表面打磨，而更薄的 27 號砂輪需要檢查製造商的標籤，以查看該砂輪是可以用於表面打磨，還是只能用於邊緣打磨/切削。禁止表面打磨時，所有砂輪必須搭配使用 1 號防護罩。切削也可以採用 41 號砂輪和 1 號防護罩進行。

**注意：**請參閱配件表以選取適當的防護罩/配件組合。

## 安裝和調整 One-Touch™ 護板 (圖 E)



**警告：**若要降低嚴重人身傷害的風險，請在運輸、進行調整、清潔、維修或卸下/安裝附件或配件之前，關閉工具並取出電池組或電源供應器。意外啟動工具可能會造成傷害。

### 調整護板

如需調整護板，護板釋放桿 9 會通過棘輪裝置與護板夾頭上的定位孔 15 接合。

接合面是傾斜的，並將在順時針（主軸面向用戶）轉動護板時，轉入下一個定位孔；逆時針轉動就會自鎖。

## 安裝護板 (圖 E)

1. 按下防護罩釋放桿 **9**。
2. 在讓防護罩釋放杆處於打開狀態時，用齒輪箱上的滑槽 **13** 調整防護罩上的接片 **14**。
3. 讓防護罩釋放杆保持打開狀態，向下按壓防護罩，在其接片啮合後，在齒輪箱輪殼上的凹槽中轉動它們。鬆開防護罩釋放杆。

讓主軸面對操作人員，順時針轉動防護罩直到一個理想的作業位置。按壓護板釋放桿 **9**，逆時針轉動護板。

**注意：**防護罩主體應該位於主軸和操作人員之間以最大程度地為操作人員提供保護。

防護罩釋放杆應該與防護圈上的一個定位孔 **15** 鎖定。這樣可確保防護罩是牢固的。

4. 要移除防護罩，請按照說明步驟1-3反向操作。

## 凸緣和砂輪

### 安裝不帶輪殼的砂輪 (圖 F)

**警告：**未能正確放置凸緣/緊固螺母/砂輪，可能會導致嚴重人身傷害 (或者損壞工具或砂輪)。

**小心：**隨附的凸緣必須與 27 號和 42 號中心凹陷的砂輪，以及 1 號和 41 號切削砂輪搭配使用。如需詳細資訊，請參閱**配件表**。

**警告：**在使用切削砂輪時，需要使用封閉式雙面切削砂輪防護罩。

**警告：**使用受損的凸緣或防護罩，或者未使用適當的凸緣或防護罩可能會由於砂輪破損或砂輪接觸而導致人身傷害。如需詳細資訊，請參閱**配件表**。

1. 將工具放置在工作台上，防護罩朝上。
2. 將支撐法蘭 **6** 安裝到主軸 **4** 上，讓凸起的中心 (導杆) 面向砂輪。將支撐法蘭按壓到位。
3. 將砂輪 **20** 緊靠支撐凸緣，讓砂輪在支撐凸緣上凸起的中心 (導杆)居中。
4. 當按下主軸鎖按鍵時，讓六角形凹陷背朝砂輪，將鎖定法蘭 **7** 旋轉到主軸上，讓凸耳與主軸上的兩個滑槽相接合。
5. 當按下主軸鎖定按鍵時，用手或隨附的扳手擰緊鎖定法蘭 **7**。(如果情況完好，則僅使用一個鎖定法蘭。)請參見附件圖表，瞭解有關法蘭的詳細資訊。
6. 如需拆除砂輪，請按上述流程反向操作。

### 安裝砂光支撐墊 (圖 G)

**注意：**使用支撐墊的砂盤 (通常稱為纖維樹脂砂盤) 不需要防護罩。由於這些配件不需要防護罩，因此防護罩在使用時可能適合也可能不適合這些配件。

**警告：**未能正確放置凸緣/緊固螺母/砂輪，可能會導致嚴重人身傷害 (或者損壞工具或砂輪)。

**警告：**完成砂光應用後，必須重新安裝合適的防護罩來執行打磨砂輪、切削砂輪、砂紙盤、鋼絲刷和鋼絲輪應用。

1. 將支撐墊 **17** 置於或適當固定於軸心上。
2. 將砂盤 **18** 置於支撐墊 **17** 上。
3. 在按下軸心鎖 **3** 的同時，將緊固螺母 **16** 上凸出的輪殼導入砂盤和支撐墊的中心，從而將緊固螺母安裝到軸心。

4. 用手擰緊緊固螺母。然後，按下軸心鎖按鍵並旋轉砂盤，直至砂盤和緊固螺母貼緊。

5. 若要拆下砂輪，請抓住並轉動支撐墊和砂墊，同時按下軸心鎖按鍵。

### 安裝及卸下帶輪殼的砂輪 (圖 F)

帶輪殼的砂輪直接安裝在螺紋軸心上。配件的螺紋必須與軸心的螺紋相配。

1. 透過將支撐凸緣拉離工具將其拆下。
2. 用手將砂輪輪裝到軸心 **4** 上。
3. 按下軸心鎖按鍵 **3** 並使用扳手擰緊鋼絲輪的輪殼。
4. 請按上述相反的步驟操作，卸下鋼絲輪。

**注意：**若開啟工具前未能正確放置砂輪，可能會對工具或砂輪造成損壞。

### 安裝鋼絲杯刷和鋼絲輪 (圖 A)

**警告：**未能正確放置凸緣/緊固螺母/砂輪，可能會導致嚴重人身傷害 (或者損壞工具或砂輪)。

**小心：**為了降低造成人身傷害的風險，請在搬運鋼絲刷和鋼絲輪時佩戴工作手套。鋼絲刷或鋼絲輪可能會變得很鋒利。

**小心：**為了降低工具損壞的風險，鋼絲輪或鋼絲刷在安裝或使用時不得接觸防護罩。配件可能會出現不易發現的損壞，導致鋼絲從鋼絲輪或鋼絲刷配件上脫落。

將鋼絲刷或鋼絲輪直接安裝在螺紋軸心上，而無需使用凸緣。只使用螺紋輪殼隨附的鋼絲刷或鋼絲輪。只需支付額外費用，您就可以透過當地經銷商或授權維修中心獲取這些配件。

1. 將工具放置在工作台上，防護罩朝上。
2. 用手將鋼絲輪裝到軸心上。
3. 按下軸心鎖按鍵 **3** 並使用鋼絲輪或鋼絲刷輪殼上的扳手擰緊鋼絲輪。
4. 若要卸下鋼絲輪，請按上述相反的步驟操作。

**注意：**為了降低工具損壞的風險，請在開啟工具前正確放置輪殼。

## 操作之前

- 安裝防護罩及合適的圓盤或砂輪。請勿使用過度磨損的圓盤或砂輪。
- 確保支撐凸緣與鎖定凸緣已正確安裝。遵循**配件表**中提供的指示。
- 確保圓盤或砂輪以配件和工具上的箭頭方向旋轉。
- 切勿使用已損壞的配件。每次使用前，請檢查配件，例如檢查砂輪是否有碎裂和裂縫，檢查支撐墊是否有裂縫、撕裂或過度磨損，檢查鋼絲刷是否鬆動或鋼絲是否斷裂。若電動工具或配件跌落，請檢查是否損毀，或立即安裝未破損的配件。檢查並安裝配件後，讓自己和旁觀者遠離配件的旋轉範圍，並讓電動工具以最大的空載速度運行一分鐘。受損配件一般會在此測試過程中碎裂。

## 操作

### 使用說明

**警告：**務必遵守安全指示和適用的規則。

**警告：**若要降低嚴重人身傷害的風險，請在運輸、進行調整、清潔、維修或卸下/安裝附件或配件之前，關閉工具並取出電池組或電源供應器。意外啟動工具可能會造成傷害。

## 正確的雙手放置位置 (圖 H)

**警告：**為降低遭受嚴重人身傷害的風險，務必如圖示那樣正確放置雙手。

**警告：**為了減低造成嚴重人身傷害的風險，預期有突然反應時務必握緊。

正確的手部位置要求一隻手握住副手柄 5，另一隻手握住輔助手柄，如圖 H 所示。

## 滑塊開關 (圖 A)

**警告：**握緊副手柄和工具主體，在啟動、使用時，以及砂輪或配件停止轉動前，保持對工具的控制。先確保砂輪完全停止轉動，然後再將工具放下。

**注意：**為減少意外的工具移動，請勿在帶有載荷的情況下打開或關閉工具。請先讓砂光機達到全速運行的狀態，再讓其接觸工件表面。先將工具從工件表面拉起，然後再關閉工具。先讓工具停止轉動，再將其放下。

**警告：**在為工具接通電源前，請按下開關的後部並鬆開，以確保滑動開關處於關閉位置。請在出現任何工具斷電的情況，例如電池沒電後，確保滑動開關處於上述關閉位置。如需啟動工具，請向前推動滑動開關 1。如需停止工具，請鬆開滑動開關。

如需持續運行，請向前推動滑動開關並向內按住開關的前部。如需讓處於持續運行模式的工具停止，請按下滑動開關的後部並鬆開。

## 軸心鎖 (圖 I)

軸心鎖 3 可在安裝或卸下砂輪時防止軸心旋轉。只能在工具關閉、拔出電源插頭且完全停止時使用軸心鎖。

**注意：**為了降低工具損壞的風險，切勿在工具運行時使用軸心鎖。否則將損壞工具，附著的配件可能會甩脫，從而導致傷害。

若要使用軸心鎖，請按下軸心鎖按鈕並旋轉軸心，直到無法再旋轉為止。

## 表面打磨、砂光和鋼絲刷

**小心：**務必依據本手冊中的說明使用正確的防護罩。

若要在工件表面執行工作：

- 讓工具達到全速然後再將工具移至工作表面。
- 施加最小壓力到工作表面上，讓工具在高速下工作。當工具在高速下工作時，材料去除率最大。
- 讓工具與工作表面之間保持適當的角度。請依照特定功能參閱圖表。

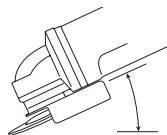

| 功能 | 角度      |
|----|---------|
| 打磨 | 20°-30° |

| 功能      | 角度     |
|---------|--------|
| 使用砂紙盤砂光 | 5°-10° |
| 使用支撐墊砂光 | 5°-15° |
| 鋼絲刷     | 5°-10° |

- 讓砂輪邊緣與工作表面之間保持接觸。
  - 如需打磨、使用砂紙盤砂光或鋼絲刷，請前後持續移動工具，以避免在工作表面上產生溝槽。
  - 如需使用支撐墊磨削，請沿直線持續移動工具，以防止工作表面上留下發熱或旋轉標記。

**注意：**讓工具靠在工作表面上不移動會使工件受損。

- 從工作表面移除工具，然後再關閉工具。讓工具停止旋轉後再將其放下。

**小心：**在處理邊緣時需格外小心，因為此時砂輪機可能出現突然的大幅運動。

## 處理漆面工件需採取的預防措施

- 不建議對含鉛油漆進行刷光或鋼絲刷操作，因為控制污染塵埃比較困難。鉛中毒對兒童及孕婦的危害最大。
- 由於在沒有化學分析的情況下難以確定油漆是否含鉛，因此我們建議在對任何漆面進行打磨時採取下列預防措施。

## 人身安全

- 在完成所有清理工作前，兒童或孕婦不應進入正在執行漆面打磨或刷光的工作區域。
- 進入工作區域的所有人應佩戴防塵面罩或口罩。過濾器應每天或在佩戴者難以呼吸時更換。
 

**注意：**應僅使用對含鉛油漆塵埃及氣體提供防護的防塵面罩。普通油漆面罩不提供此防護功能。請諮詢當地的五金經銷商，了解經美國職業安全及衛生研究院 (NIOSH) 批准的合適口罩。
- 不應在工作區域進食、飲水或吸煙，以防吸入油漆污染顆粒。工作人員應在進食、飲水或吸煙前洗手和清理。食品、飲料或煙草不應留下工作區域，塵埃會沉積在它們上面。

## 環境安全

- 移除油漆時應將產生的塵埃量減到最少。
- 移除油漆的區域應使用 4 公釐厚的塑料片密封。
- 打磨時應儘量減少工作區域外油漆粉塵的痕跡。

## 清潔和處理

- 在執行打磨作業期間，應每天對工作區域中所有表面進行真空清掃和徹底清潔。應經常更換真空過濾袋。
- 滴塑布應該與塵埃或其他碎片收集在一起並處理。應該將它們放入密封的垃圾容器內，並透過常規垃圾收集程序進行處理。清理期間，兒童和孕婦應該遠離工作區域。

所有玩具、可清洗之家具及兒童用品應徹底清洗，然後再使用。

## 邊緣打磨和切削

**警告：**請勿將邊緣打磨/切削砂輪用於表面打磨，因為這些砂輪的設計無法承受表面打磨所遇到的側壓力。可能導致砂輪斷裂和人身傷害。

**小心：**若在使用工具時用來邊緣打磨和切削的砂輪出現彎曲或扭曲，則可能發生碎裂或反衝。在所有邊緣打磨/切削操作中，防護罩開口側不得朝向操作人員。

**注意：**使用 27 號砂輪的邊緣打磨/切削範圍必須限制為淺挖和開槽 - 新砂輪的深度小於 13 公釐。隨著砂輪磨損，砂輪半徑會縮短，切割/開槽深度也會減小。如需詳細資訊，

請參閱**配件表**。使用 41 號砂輪進行邊緣打磨/切削需要使  
用 1 號防護罩。

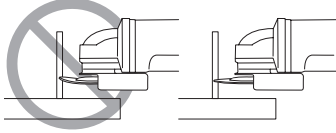

1. 讓工具達到全速然後再將工具移至工作表面。
2. 施加最小壓力到工作表面上，讓工具在高速下工作。當工具在高速下工作時，打磨/切削率最大。
3. 不要面向砂輪開口的下側。
4. 一旦開始切削並在工件留下缺口，請勿改變切削角度。改變角度會造成砂輪彎曲並可能導致砂輪斷裂。邊緣打磨砂輪的設計無法承受彎曲造成的側壓力。
5. 從工作表面移除工具，然後再關閉工具。讓工具停止旋轉後再將其放下。

## 金屬應用

如果將該工具用於切割金屬，請確保插入了剩餘電流裝置 (RCD)，避免由金屬屑造成的剩餘電流風險。

如果電源被 RCD 關閉，請將該工具送至獲得授權的 DeWALT 維修代理機構。

**警告：**在極端作業環境中，導電粉塵會在加工金屬時累積在機器外殼的內側。這會導致機器中的保護性絕緣被削弱，有潛在的觸電風險。

為避免機器內部累積金屬屑，我們建議每天清潔通風槽。請參見“維護”部分。

## 金屬切割

**若要切割黏合的研磨產品，務必使用 1 號防護罩。**

切割時，使用適量的進料，並根據被切割材料相應調整。請勿在切盤上施壓，使機器傾斜或擺動。

請勿透過施加側向壓力來降低切盤的運轉速度。

機器必須始終以逆磨運動工作。否則，會存在被推出切割位置發生失控的危險。

切割型材和方棒時，最好從最小的橫截面開始切割。

## 粗打磨

**切勿使用切盤來進行粗打磨。**

**請始終使用 27 號防護罩。**

當將機器角度設為 30° 至 40° 時，可達到最佳的粗打磨效果。以適中壓力來回移動機器。這樣，工件溫度才不會變得太高，不會變色並且不會出現凹坑。

## 切割石材

**機器應該僅用於乾切割。**

如需切割石材，最好使用金剛石切盤。僅在使用額外防塵面罩時操作機器。

## 工作建議

**在結構牆上開槽時，請謹慎操作。**

結構牆上開槽必須遵守特定於國家/地區的規定。所有情況下都必須遵守這些規定。開始工作前，請諮詢負責的結構工程師、建築師或施工主管。

## 維護

DeWALT 電動工具採用卓越的設計，能夠長時間使用，並且只需最少的維護。若要持續獲得滿意的操作效果，需進行正確的工具維護和定期的清潔。

**警告：**為了減低造成嚴重人身傷害的風險，在進行任何調整或卸下或安裝附件或配件之前，切記關掉工具的電源並取出電池組。意外啟動工具可能會造成傷害。

充電器和電池組是不可檢修的裝置。



## 潤滑

本電動工具毋需額外潤滑。



## 清潔

**警告：**一旦通風口及其周圍積聚可見的粉塵，請立即使用乾燥的壓縮空氣吹掉主機外殼內的粉塵和灰塵。執行此步驟時，請佩戴經認可的護目裝備和防塵面罩。

**警告：**切勿使用溶劑或其他刺激性化學品來清潔工具的非金屬部件。這些化學品可能會削弱部件中使用的材料。只能使用抹布蘸中性肥皂水進行清潔。不要讓任何液體進入工具；不要讓工具的任何部分浸入液體中。

## 選購配件

**警告：**由於非 DeWALT 所提供的配件未在本產品上進行過使用測試，在本產品上使用這些附件可能發生危險。為降低傷害危險，在本產品上只應使用 DeWALT 所推薦的配件。

如需進一步瞭解適用配件的相關資訊，請洽詢當地代理商。

## 保護環境



分類回收。帶有此標誌的產品和電池必須與一般家庭廢物分開處置。

產品和電池包含可重複使用或回收的材料，可降低對原材料的需求。請根據當地法規回收電氣產品和電池。更多資訊，請造訪 [www.2helpU.com](http://www.2helpU.com)。

## 可充電電池組











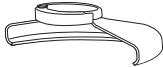

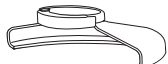
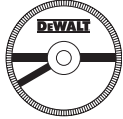

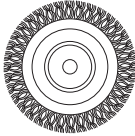
本電池組使用壽命長，若無法為以前輕鬆完成的工作提供充足電力，必須更換電池組。在使用壽命結束時，請妥善處置以保護我們的環境：

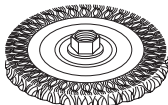
- 使電池完全放電，然後將它從工具中卸下。
- 鋰離子電池是可回收的。請將它們送往您的代理商或當地的回收站。所收集的電池組將會再循環利用或妥善處置。

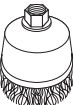
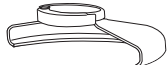

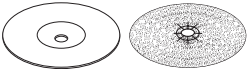

## 售後服務和維修

DeWALT 服務中心有經過培訓的專門人員，可向顧客提供高效、可靠的產品服務。如果您在未獲授權的服務中心進行維修，我們將不會承擔任何責任。您可以查看產品包裝上“客服中心位置”宣傳單頁，通過熱線電話、網站或社交媒體與我們聯繫，找到距離您最近的 DeWALT 服務中心。

## 配件表

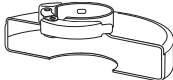
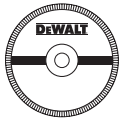
| 防護罩類別   | 配件  | 說明        | 如何安裝砂輪機  |
|---|---|-----------|--|
| <br>27 號防護罩 |    | 中心凹陷打磨圓盤  | <br>27 號防護罩   |
|   |    | 砂布輪       | <br>支撐凸緣  |
|   |    | 鋼絲輪       | <br>27 號中心凹陷砂輪<br><br>鎖定凸緣   |
|   |    | 帶螺紋螺母的鋼絲輪 | <br>27 號防護罩<br><br>鋼絲輪   |
|   |    | 帶螺紋螺母的鋼絲杯 | <br>27 號防護罩<br><br>鋼絲刷  |
|   |  | 支撐墊/砂光板   | <br>27 號防護罩<br><br>橡膠支撐墊<br><br>砂盤<br><br>緊固螺母 |

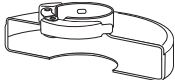
## 配件表 (續)

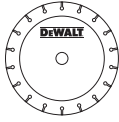
| 防護罩類別  | 配件   | 說明   | 如何安裝砂輪機  |
|--|--|--|--|
| <br>1 號防護罩 | <br>粘合的磚石切<br>削圓盤 | <br>粘合的金屬<br>切盤 | <br>1 號防護罩<br><br><br>支撐凸緣 |
|  | <br>金剛石切削<br>砂輪   |  |  |

**進 口 商:** 新加坡商百得電動工具(股)公司台灣分公司

**地 址:** 台北市士林區德行西路33號2樓

**電 話:** 02-28341741

**總 經 銷 商:** 永安實業股份有限公司

**地 址:** 地址: 新北市三重區新北大道二段137號

**電 話:** 電話: 02-29994633

# 슬라이드 스위치 그라인더

## DCG409

### 축하합니다!

DeWALT 공구를 선택해 주셔서 감사합니다. DeWALT는 오랜 경험을 토대로 한 제품 개발 및 혁신을 통해 전문 사용자들이 가장 인정하는 기업으로 자리잡아왔습니다.

### 기술 데이터

|              | DCG409-TW                   | DCG409-B1   | DCG409-KR   | DCG409NT-A9 |
|--------------|-----------------------------|-------------|-------------|-------------|
| 전압           | V <sub>DC</sub> 18 (20 Max) | 18 (20 Max) | 18 (20 Max) | 18 (20 Max) |
| 배터리 유형       | 리튬 이온                       | 리튬 이온       | 리튬 이온       | 리튬 이온       |
| 전원 출력        | W                           | 1647        | 1647        | 1647        |
| 정격 속도        | min <sup>-1</sup>           | 9000        | 9000        | 9000        |
| 휠 직경         | mm                          | 125         | 100         | 125         |
| 휠 두께 (최대)    | mm                          | 6           | 4           | 6           |
| 스핀들 직경       |                             | M14         | M10         | M10         |
| 스핀들 길이       | mm                          | 21.5        | 16          | 16          |
| 무게(배터리 팩 제외) | kg                          | 1.81        | 1.62        | 1.73        |

이 정보 사이트에 제공된 진동 및 / 또는 소음 방출 수준은 EN60745 에 제공된 표준화 된 테스트에 따라 측정되었으며 한 공구를 다른 공구와 비교하는 데 사용할 수 있습니다. 노출의 예비 평가에 사용할 수 있습니다.

**경고:** 제시 된 진동 및 / 또는 소음 방출 수준은 공구의 주요 응용 분야를 나타냅니다. 그러나 공구가 다른 용도, 다른 액세서리와 함께 사용되거나 제대로 관리되지 않으면 진동 및 / 또는 소음 방출이 다를 수 있습니다. 이것은 전체 작업 기간 동안 노출 수준을 크게 증가시킬 수 있습니다.

진동 및 / 또는 소음에 대한 노출 수준을 평가할 때는 공구가 꺼져 있거나 작동 중이지만 실제로는 작업을 수행하지 않는 시간도 고려해야 합니다. 이것은 전체 작업 기간 동안 노출 수준을 현저히 감소시킬 수 있습니다.

다음과 같은 진동 및 / 또는 소음의 영향으로부터 작업자를 보호하기 위한 추가 안전 조치를 식별합니다. 예를 들면: 공구 및 액세서리 유지관리, 손을 따뜻하게 유지(진동 관련), 작업 패턴 구성.



**경고:** 부상 위험을 줄이려면 사용 설명서를 읽으십시오.

### 정의: 안전 지침

다음 정의는 각 경고 문구의 심각도를 설명합니다. 사용 설명서를 읽고 다음 기호들에 유의하십시오.



**위험:** 절박한 위험 상태를 나타내며, **방지하지 않으면, 사망 또는 심각한 부상을 초래합니다.**



**경고:** 잠재적 위험 상태를 나타내며, **방지하지 않으면 사망 또는 심각한 부상을 초래할 수 있습니다.**



**주의:** 잠재적으로 위험한 상태를 나타내며, **방지하지 않으면 경미하거나 가벼운 부상을 초래할 수 있습니다.**

**참고:** 신체 부상을 초래하지 않는 행위를 나타내며 **방지하지 않으면 재산상의 손해가 발생할 수 있습니다.**



감전 위험을 나타냅니다.



화재 위험을 나타냅니다.

| 배터리           |                   |          |         | 충전기/충전 시간 (분) |        |        |        |         |         |        |         |
|---------------|-------------------|----------|---------|---------------|--------|--------|--------|---------|---------|--------|---------|
| 카탈로그 번호       | V <sub>DC</sub>   | Ah       | 중량 (kg) | DCB104        | DCB107 | DCB112 | DCB115 | DCB117  | DCB118  | DCB132 | DCB1112 |
| DCB546/DCB606 | 18/54 (20/60 Max) | 6.0/2.0  | 1.05    | 60            | 270    | 170    | 90     | 40      | 60      | 90     | 40      |
| DCB547/DCB609 | 18/54 (20/60 Max) | 9.0/3.0  | 1.46    | 75*           | 420    | 270    | 135*   | 60      | 75*     | 135*   | 60      |
| DCB548/DCB612 | 18/54 (20/60 Max) | 12.0/4.0 | 1.44    | 120           | 540    | 350    | 180    | 80      | 120     | 180    | 80      |
| DCB181        | 18 (20 Max)       | 1.5      | 0.35    | 22            | 70     | 45     | 22     | 22      | 22      | 22     | 22      |
| DCB182/DCB204 | 18 (20 Max)       | 4.0      | 0.61    | 60/40**       | 185    | 120    | 60     | 60/40** | 60/40** | 60     | 60/40** |
| DCB183/DCB203 | 18 (20 Max)       | 2.0      | 0.40    | 30            | 90     | 60     | 30     | 30      | 30      | 30     | 30      |
| DCB184/DCB205 | 18 (20 Max)       | 5.0      | 0.62    | 75/50**       | 240    | 150    | 75     | 75/50** | 75/50** | 75     | 75/50** |
| DCB185        | 18 (20 Max)       | 1.3      | 0.35    | 22            | 60     | 40     | 22     | 22      | 22      | 22     | 22      |
| DCB187        | 18 (20 Max)       | 3.0      | 0.54    | 45            | 140    | 90     | 45     | 45      | 45      | 45     | 45      |
| DCB189/DCB240 | 18 (20 Max)       | 4.0      | 0.54    | 60            | 185    | 120    | 60     | 60      | 60      | 60     | 60      |
| DCB186        | 18 (20 Max)       | 6.0      | 0.95    | 60            | 270    | 170    | 90     | 60      | 60      | 90     | 60      |

\*날짜 코드 2018114758 또는 그 이후

\*\*날짜 코드 201536 또는 그 이후

## 전동 공구에 관한 일반 안전 경고



**경고:** 이 전동 공구와 함께 제공되는 모든 안전 경고와 지시사항, 설명 및 사양을 읽으십시오. 아래 설명한 모든 지시 사항을 따르지 않으면 감전, 화재 및/또는 심각한 부상을 초래할 수 있습니다.

**항후 참고할 수 있도록 모든 경고 및 지시 사항을 보관해두십시오.**

경고에서 사용된 "전동 공구"라는 용어는 주 공급 전원에 의해 전기가 공급되는(유선) 전동 공구 또는 충전식(무선) 전동 공구를 의미합니다.

### 1) 작업장 안전

- 작업장을 항상 청결하고 밝게 유지하십시오. 혼잡하거나 어두운 작업장에서는 사고가 발생하기 쉽습니다.
- 가연성 액체, 가스 또는 먼지 등이 있는 폭발성 대기에서 전동 공구를 사용하지 마십시오. 전동 공구에서 먼지나 가스를 발사시킬 수 있는 불꽃이 될 수 있습니다.
- 전동 공구로 작업하는 동안에는 어린이와 주변 사람들이 작업 영역에 가까이 들어오지 못하도록 하십시오. 주변이 산만해져 통제력을 잃을 수 있습니다.

### 2) 전기 안전

- 동공구의 플러그는 콘센트와 형식이 일치해야 하며, 플러그를 어떤 형태로든 개조하지 마십시오. 또한 접지된 전동공구에 다른 어댑터 플러그를 사용하지 마십시오. 개조되지 않은 플러그 및 형식이 일치하는 콘센트를 사용하면 감전 위험이 줄어듭니다.
- 파이프 관, 라디에이터, 렌지, 냉장고 등의 접지 표면에 물이 닿지 않도록 하십시오. 몸에 닿을 경우 감전이 될 위험이 높아집니다.
- 전동 공구를 비 또는 습한 환경에 노출하지 않도록 주의하십시오. 전동 공구에 물이 들어가면 감전 위험이 높아집니다.
- 코드를 함부로 다루지 마십시오. 코드를 사용하여 전동공구를 운반하거나, 코드를 과도하게 잡아당겨서 플러그를 뽑지 않도록 주의하십시오. 전열코드가 열기 또는 오일과 접촉되는 것을 피하고, 날카로운 모서리 또는 기기의 기둥 부위에 닿지 않도록 주의 하십시오. 코드가 손상되거나 얽혀 있으면 감전 위험이 높아집니다.
- 전동 공구를 실외에서 사용할 때는 실외 사용에 적합한 연장 코드를 사용하십시오. 실외 사용에 적합한 코드를 사용하면 감전 위험이 줄어듭니다.
- 전동공구를 습한 공간에서 사용할 경우, 반드시 누전 차단기를 사용하십시오. 누전 차단기(RCD)를 사용하면 감전의 위험이 줄어듭니다. RCD를 사용하면 감전 위험이 줄어듭니다.

### 3) 신체 안전 사항

- 전동 공구로 작업할 때는 방심하지 말고 작업에 주의하면서 상식에 따르십시오. 피곤한 상태이거나 약물, 술, 치료제를 복용한 상태에서는 전동 공구를 사용하지 마십시오. 전동 공구를 사용하다 잠깐만 한 눈을 팔아도 심각한 부상을 당할 수 있습니다.
- 신체 보호 장비를 착용하십시오. 항상 보안경을 착용하십시오. 적합한 상황에서 방진 마스크, 미끄럼 방지 안전화, 안전모 또는 청력 보호 기구 등의 보호 장비를 사용하면 신체 부상 위험이 줄어듭니다.
- 의도하지 않은 장비 가동 방지. 전원 및/또는 배터리 팩에 연결한 상태로 공구를 선택 또는 운반할 때는 사전에

스위치가 꺼짐 위치에 있는지 반드시 확인하십시오.

스위치가 켜짐 위치에 있는 상태에서 스위치에 손가락이 닿은 상태로 전동 공구를 운반하거나 전동 공구에 전원을 공급하면 사고가 발생합니다.

- 전동 공구를 켜기 전에 모든 조정 키 또는 렌치를 제거하십시오. 전동 공구의 회전 부품에 렌치나 키가 부착되어 있으면 부상을 당할 수 있습니다.
- 무리하게 팔을 뻗지 마십시오. 항상 올바른 자세로 서서 균형을 유지하십시오. 안정된 자세로 작업을 할 경우 전동 공구를 안전하게 사용할 수 있습니다.
- 절한 의복을 착용하십시오. 헐렁한 옷이나 장신구를 착용하지 마십시오. 머리카락과 옷이 움직이는 부품에 닿지 않도록 유의하십시오. 헐렁한 옷, 장신구 또는 긴 머리카락이 움직이는 부품에 걸 수 있습니다.
- 먼지 배출 및 집진 시설 연결을 위한 장치가 제공된 경우, 이를 장치가 연결되어 적절히 사용되고 있는지 반드시 확인하십시오. 집진 장치를 사용하면 먼지와 관련된 위험을 줄일 수 있습니다.
- 장치를 자주 사용함으로써 생긴 익숙함으로 인해 현실에 안주하거나 공구 안전 원칙을 무시하지 않도록 하십시오. 부주의한 작동은 순식간에 심각한 부상을 야기할 수 있습니다.

### 4) 전동 공구 사용 및 관리

- 전동 공구에 무리한 힘을 가하지 마십시오. 해당 용도에 맞는 올바른 전동 공구를 사용하십시오. 올바른 전동 공구를 사용해야 설계된 속도로 작업을 더욱 안전하고 정확하게 수행할 수 있습니다.
- 켜지지 않거나 꺼지지 않는 경우 전동 공구를 사용하지 마십시오. 스위치로 제어되지 않는 전동 공구는 위험하므로 수리해야 합니다.
- 전동 공구를 조정하거나 액세스리리를 변경하거나 보관하기 전에 전동 공구에서 분리되는 경우 전원에서 플러그를 뽑거나 또는 배터리 팩을 분리하십시오. 이러한 예방적 안전 조치를 따라야 전동 공구가 갑자기 작동할 위험이 줄어듭니다.
- 사용하지 않는 전동 공구는 어린이의 손이 닿지 않는 곳에 보관하고, 전동 공구나 본 지시 사항에 익숙하지 않은 사람이 전동 공구를 절대 사용하지 못하게 하십시오. 전동 공구는 훈련을 받지 않은 사용자가 다루면 위험합니다.
- 전동 공구 및 액세스리리 유지 보수. 움직이는 부품의 잘못된 정렬이나 바인딩, 부품 파손 및 기타 전동 공구의 작동에 영향을 미칠 수 있는 기타 모든 상태를 확인하십시오. 손상된 부분이 있는 경우 사용하기 전에 전동 공구를 수리하십시오. 많은 사고는 전동 공구를 제대로 유지 보수하지 않아 발생합니다.
- 공구를 깨끗한 상태로 유지하십시오. 깨끗한 상태를 유지하면 공구를 사용할 때 바인딩이 적고 다루기가 용이합니다.
- 작업 환경과 수행할 작업을 고려하여, 본 지시 사항에 따라 전동 공구, 액세스리리 및 톨 비트 등을 사용하십시오. 본 사용자 설명서의 내용과 다른 용도로 전동 공구를 사용하면 위험한 상황이 발생할 수 있습니다.
- 핸들과 잡는 표면은 건조하고 깨끗한 상태를 유지하고 오일/기름이 묻지 않도록 하십시오. 미끄러운 핸들과 잡는 면은 예기치 못한 상황에서 안전한 취급과 공구 관리를 보장하지 않습니다.



## 5) 배터리 공구 사용 및 주의 사항

- a) 다시 충전할 때는 제조업체에서 지정한 충전기만 사용하십시오. 하나의 배터리 팩 유형에 적합한 충전기를 다른 배터리 팩과 함께 사용할 경우 화재의 위험이 있습니다.
- b) 전동 공구를 사용할 때는 구체적으로 지정되어 있는 배터리 팩만 사용하십시오. 다른 배터리 팩을 사용하면 부상을 입거나 화재의 위험이 있습니다.
- c) 배터리 팩을 사용하지 않을 때에는 클립, 동전, 키, 못, 나사 등의 금속 물체나, 단자 간에 연결할 수 있는 작은 금속 물체가 닿지 않도록 멀리 두십시오. 배터리 단자가 단락되면 화상을 입거나 화재의 위험이 있습니다.
- d) 배터리를 과다 사용하면 액체가 배터리에서 흘러 나올 수 있으므로, 접촉을 피하십시오. 실수로 접촉한 경우에는 물로 씻으십시오. 액체가 눈에 들어간 경우 치료를 받으십시오. 배터리에서 나온 액체는 통증을 유발하거나 화상을 입힐 수 있습니다.
- e) 손상되거나 변경된 배터리 팩 또는 공구를 사용하지 마십시오. 손상되거나 개조된 배터리는 예측할 수 없는 작용을 보여, 화재, 폭발 또는 부상 위험을 야기할 수 있습니다.
- f) 배터리 팩 또는 공구를 불이나 과도한 온도에 노출하지 마십시오. 불 또는 130 °C 이상의 온도에 노출되면 폭발할 수 있습니다.
- g) 모든 충전 지침을 따르고 배터리 팩 또는 공구를 설명서에 지정된 범위 밖의 온도에서 충전하지 마십시오. 적절하지 않게 충전하거나 지정된 범위 밖의 온도에서 충전하면 배터리가 손상되어 화재 위험이 증가될 수 있습니다.

## 6) 정비

- a) 자격을 갖춘 기술자가 동일 교체 부품을 사용하여 정비 작업을 수행해야 합니다. 그래야 전동 공구의 안전이 보장됩니다.
- b) 손상된 배터리 팩을 정비하지 마십시오. 배터리 팩은 제조업체 또는 공인 서비스 공급업체를 통해서만 점검을 받아야 합니다.

## 추가적인 특정 안전 규칙

### 모든 조작에서의 안전 지시 사항

- a) 이 전동 공구는 그라인더, 샌더, 와이어 브러시 또는 컷오프 공구로 사용됩니다. 이 전동 공구와 함께 제공되는 모든 안전 경고와 지시사항, 설명 및 사양을 읽으십시오. 아래 설명한 모든 지시 사항을 따르지 않으면 감전, 화재 및/또는 심각한 부상을 초래할 수 있습니다.
- b) 연마, 샌딩, 와이어 브러싱 같은 작업은 이 전동 공구로 수행하기에는 적합하지 않습니다. 전동 공구 설계 용도 이외의 작업은 제품의 파손 및 작업자 신체의 위험, 부상 등을 유발 할 수 있습니다.
- c) 공구 제조업체가 구체적으로 설계하고 권장하지 않은 액세서리는 사용하지 마십시오. 전동 공구에 부착할 수 있다고 해서 반드시 안전하게 조작할 수 있는 것은 아닙니다.
- d) 액세서리의 정격 속도는 최소한 전동 공구에 표기되어 있는 최대 속도와 같아야 합니다. 정격 속도보다 빠르게 작동하는 액세서리는 파손되어 튕겨 나갈 수 있습니다.
- e) 액세서리의 외경 및 두께는 사용하는 전동 공구의 용량 등급 이내이어야 합니다. 잘못된 규격의 액세서리는 제대로 보호하거나 제어할 수 없습니다.

- f) 액세서리의 나사산 장착은 그라인더 스펀들 나사산과 일치해야 합니다. 플랜지로 장착한 액세서리의 경우 액세서리의 주축 구멍이 플랜지의 로케이팅 직경에 맞아야 합니다. 전동 공구에 장착할 하드웨어와 맞지 않는 액세서리는 균형을 잃어 과도하게 진동하며 통제할 수 없게 됩니다.
- g) 손상된 액세서리는 사용하지 마십시오. 사용 전에 항상 액세서리를 검사해 연삭 칩이 깎이거나 갈라지지 않았는지, 이면 패드가 갈라지거나 찢어지거나 과도하게 마모되지 않았는지, 와이어 브러시의 와이어가 느슨하거나 갈라지지 않았는지 확인하십시오. 전동 공구나 액세서리를 떨어뜨린 경우에는 손상된 부분이 없는지 검사하고 손상된 부분이 있을 경우 손상되지 않은 액세서리를 설치하십시오. 액세서리를 검사 및 설치한 뒤 회전하는 액세서리 작업대에서 멀리 거리를 유지하고 전동 공구를 1분 간최대 무부하 속도로 작동시키십시오. 액세서리가 손상된 경우 보통 이 테스트 중에 떨어져 나갑니다.
- h) 신체 보호 장비를 착용하십시오. 용도에 따라 안면보호구, 안전 고글 또는 보안경을 이용하십시오. 필요에 따라 연마휠 또는 가공품 파편을 막을 수 있는 마스크, 청력보호구, 장갑 및 앞치마를 착용하십시오. 보안경은 다양한 작업으로 인해 생성되는 비산 파편들을 차단할 수 있어야 합니다. 마스크나 방독 마스크는 작업으로 인해 생성되는 먼지를 거를 수 있어야 합니다. 높은 소음에 오랫동안 노출되면 청력이 손상될 수 있습니다.
- i) 주변 사람들이 작업 영역으로부터 안전 거리를 유지하게 하십시오. 작업 영역에 들어오는 사람들은 모두 신체 보호장구를 착용해야 합니다. 가공품 또는 손상된 액세서리 파편이 작업 중인 곳을 벗어나 멀리 날아가 부상을 입힐 수 있습니다.
- j) 부속품이 숨겨진 배선이나 자체 코드에 닿을 수 있는 작업을 수행할 때는 절연 그림 표면으로 전동 공구를 잡으십시오. "실제"와이어에 접촉하는 액세서리는 전동 공구의 금속 부분이 "실제"로 노출되어 작업자에게 감전될 수 있습니다.
- k) 절대 액세서리가 완전히 멈출 때까지 전동 공구를 내려놓지 마십시오. 회전 액세서리가 표면에 튕겨 전동 공구를 제어하지 못하게 될 수 있습니다.
- l) 전동 공구를 허리에 차고 이동할 때는 작동시키지 마십시오. 회전 액세서리와 실수로 닿게 되면 옷이 휘감겨 액세서리가 신체에 박힐 수 있습니다.
- m) 전동 공구의 통풍구를 주기적으로 청소하십시오. 모터의 팬은 하우징 내부로 먼지를 흡입하는데 금속 가루가 너무 많이 쌓이면 전기 장치가 고장날 수 있습니다.
- n) 가연성 물질 근처에서 전동 공구를 작동시키지 마십시오. 스파크로 인해 점화가 될 수 있습니다.
- o) 냉각용 액체가 필요한 액세서리는 사용하지 마십시오. 물이나 기타 액체 냉매를 이용하면 감전사고 또는 감전될 수 있습니다.
- p) 이 공구에 타임 11 (플레이어 컵) 휠을 사용하지 마십시오. 부적절한 액세서리를 사용하면 부상을 입을 수 있습니다.
- q) 항상 측면 손잡이를 사용하십시오. 핸들을 단단히 조이십시오. 항상 사이드 컨트롤을 사용하여 공구 제어를 유지해야 합니다.



**경고:** 잔류 전류 정격이 30mA 이하인 잔류 전류 장치를 사용하는 것이 좋습니다.

## 모든 조작에서의 추가 안전 지시 사항

### 반동의 원인과 작업자 방지

반동은 꼬이거나 걸리는 회전식 휠, 백킹 패드, 브러시 또는 기타 액세서리에서 갑자기 발생합니다. 장애물에 끼거나 걸리면 회전하는 휠이 급속히 감속되어 통제력을 잃은 전동 공구가 걸린 지점에서 휠 회전 방향과 반대되는 방향으로 밀립니다.

예를 들어, 연마 휠이 공작물에 걸리거나 끼일 경우, 핀치 지점으로 들어가는 휠의 가장자리가 재료의 표면을 파고 들어 휠이 튀어 나오거나 튀어 나올 수 있습니다. 끼임 지점에서 휠의 움직임 방향에 따라 휠이 작업자쪽으로 또는 멀리 떨어질 수 있습니다. 이러한 조건에서는 연마 휠이 파손될 수 있습니다.

반동은 전동 공구를 잘못 사용하거나 잘못된 조작 절차 또는 조건으로 인해 발생할 수 있으며 **아래와 같은 올바른 예방 조치를 통해 막을 수 있습니다.**

- a) 전동 공구를 꼭 쥐고 반발력에 저항할 수 있는 자세를 유지하십시오. 반동이나 시동 중의 토크 반발력을 최대한 제어할 수 있도록 보조 핸들이 있으면 항상 이용하십시오. 작업자가 적절한 예방 조치를 취하면 토크 반발력이나 반동력을 제어할 수 있습니다.
- b) 절대 회전하는 액세서리 가까이에 손을 두지 마십시오. 액세서리가 손에 뿔 수 있습니다.
- c) 기계 반동이 발생할 경우 전동 공구가 움직일 수 있는 곳에 신체를 두지 마십시오. 반동은 휠이 걸린 지점에서의 휠 움직임과 반대 방향으로 공구가 튀게 합니다.
- d) 모서리, 날카로운 가장자리 등을 가공할 때는 특히 주의하십시오. 액세서리가 튀거나 걸리지 않게 하십시오. 모서리, 날카로운 가장자리 또는 단턱 있는 부분에는 회전 액세서리가 걸려 통제력을 잃거나 튀어 오르기 쉽습니다
- e) 톱 체인 목각 블레이드 또는 톱니 톱날을 부착하지 마십시오. 이럴 톱날은 반동이 생기거나 통제력을 잃게 되는 경우가 잦습니다.

### 연삭 작업과 관련된 안전 경고

- a) 전동 공구에 권장되는 휠 유형과 선택한 용도로 설계된 특정 가드 만 사용하십시오. 전동 공구가 설계되지 않은 휠은 적절히 보호할 수 없으며 안전하지 않습니다.
- b) 중앙 돌린 휠의 연삭 표면은 가드 림의 평면 아래에 장착해야 합니다. 가드 림 평면을 통해 돌출 된 잘못된 장착 된 휠은 적절히 보호할 수 없습니다.
- c) 보호대는 전동 공구에 단단히 부착되어 최대한 안전을 확보할 수 있도록 배치해야 하므로 휠의 양이 작업자에게 최소로 노출됩니다. 보호대는 깨진 휠 파편과 우발적인 휠 및 스파크의 접촉으로 의류를 점화시킬 수 없도록 작업자를 보호합니다.
- d) 휠은 권장되는 용도로만 사용해야 합니다. 예를 들어 : 차단 휠 측면으로 연마하지 마십시오. 연마 컷오프 휠은 주변 연삭을 위해 고안된 것으로, 이 휠에 가해지는 측면 힘으로 인해 휠이 부서질 수 있습니다.
- e) 선택한 휠에 맞는 크기와 모양의 손상되지 않은 휠 플랜지를 항상 사용하십시오. 적절한 휠 플랜지는 휠을 지지하여 휠 파손 가능성을 줄입니다. 컷오프 휠의 플랜지는 그라인딩 휠 플랜지와 다를 수 있습니다.

- f) 더 큰 전동 공구의 마모 된 휠을 사용하지 마십시오. 대형 전동 공구 용 휠은 소형 공구의 고속 작업에는 적합하지 않으며 파열될 수 있습니다.

### 연마 작업과 관련된 추가 안전 경고

- a) 차단 휠을 "걸리거나"과도한 압력을 가하지 마십시오. 과도한 깊이를 만들려고 하지 마십시오. 휠에 과도한 힘을 가하면 작업시 휠의 비틀림 또는 바이딩에 대한 하중 및 민감도가 높아지고 반동 또는 휠 파손 가능성이 높아집니다.
- b) 몸을 회전중의 휠과 나란히 놓지 마십시오. 작동 지점에서 휠이 몸에서 멀어질 때 가능한 반동이 회전 휠과 전동 공구를 사용자에게 직접 전달될 수 있습니다.
- c) 휠이 재분되거나 어떤 이유로 작업이 중단 된 경우, 전동 공구를 끄고 휠이 완전히 멈출 때까지 전동 공구를 움직이지 마십시오. 휠이 움직이는 동안 컷오프 휠을 제거하려고 시도하지 마십시오. 반동이 발생할 수 있습니다. 휠 바이딩의 원인을 제거하기 위해 확인하고 적절한 수정 조치를 취하십시오.
- d) 공작물에서 작업을 다시 시작하지 마십시오. 휠이 최고 속도에 도달하고 컷을 조심스럽게 다시 작동하십시오. 공작물에서 전동 공구를 다시 시작하면 휠이 재분되거나 견히거나 반동될 수 있습니다.
- e) 휠 핀치 및 반동의 위험을 최소화하기 위해 패널 또는 대형 공작물을 지지하십시오. 큰 공작물은 자체 중앙으로 치지는 경향이 있습니다. 지지선은 작업선 근처와 휠 양쪽의 공작물 가장자리 근처에 공작물 아래에 있어야 합니다.
- f) 기존 벽이나 다른 사각 지대에 "포켓 컷"을 만들 때 특히 주의하십시오. 돌출 휠은 가스 나 수도관, 전기 배선 또는 기계 반동을 유발할 수 있는 물체를 작업할 수 있습니다.

### 샌딩 작업에 관한 특정 안전 경고

- a) 지나치게 큰 샌딩지를 사용하지 마십시오. 샌딩지를 선택할 때 제조업체의 권장 사항을 따르십시오. 샌딩 패드 너머로 뻗어있는 더 큰 샌딩 페이퍼는 열상을 입을 수 있으며 디스크가 찢어지거나 반동될 수 있습니다.

### 와이어 브러싱 작업과 관련된 안전 경고

- a) 정상적인 작동 중에도 브러시로 와이어 강모가 발생합니다. 브러시에 과도한 하중을 가하여 전선에 무리한 힘을 가하지 마십시오. 와이어 강모는 가벼운 옷이나 피부에 쉽게 침투할 수 있습니다.
- b) 와이어 브러싱에 가드 사용을 권장하는 경우 와이어 휠이나 브러시가 가드와 간섭하지 않도록 하십시오. 와이어 휠 또는 브러시는 작업 및 원심력으로 인해 직경이 확장될 수 있습니다.

### 기타 발생 가능한 위험

관련된 안전 규정을 준수하고 안전 장치를 사용한다고 해도 특정한 위험은 피할 수 없습니다. 이러한 위험은 다음과 같습니다.

- 청력 손상.
- 파편 날림으로 인한 신체 부상 위험.
- 작업 중 தொடு워지는 액세서리로 인한 화상 위험.
- 장시간 사용으로 인한 신체 부상의 위험.
- 유해 물질로 인한 먼지 위험.

## 충전기

DeWALT 충전기는 어떠한 조절 작업도 필요 없으며 최대한 작동하기 쉽게 설계되었습니다.

### 전기 안전

전기 모터는 한 가지 전압에만 맞추어 설계되었습니다. 배터리 팩 전압이 명판에 기재된 전압과 일치하는지 항상 확인하십시오. 또한 충전기의 전압이 주전원의 전압과도 일치하는지 확인하십시오.



DeWALT 충전기는 IEC60335 에 따라 이중 절연되어 있습니다. 따라서 접지선이 필요하지 않습니다.

전원 코드가 손상된 경우 DeWALT 또는 공인 서비스 기관 만 교체해야 합니다.

### 연장 케이블 이용

연장 코드는 가끔씩 사용하지 마십시오. 사용 중인 전원공급기 정격전원에 맞는 승인된 연장 코드를 사용하십시오 (기술 데이터 참조). 최소 도체 크기는 1mm<sup>2</sup>, 최대 길이는 30m입니다.

케이블 릴을 사용할 때는 항상 케이블을 완전히 푸십시오.

### 모든 배터리 충전기에 대한 중요한 안전 지침

본 지침을 잘 보관해 두십시오. 본 사용 설명서에는 호환이 되는 배터리 충전기에 대한 중요한 안전 및 작업 지침이 포함되어 있습니다 (기술 데이터 참조).

- 충전기를 사용하기 전에 충전기, 배터리 팩, 그리고 배터리 팩 관련 제품에 대한 지침과 주의 표시를 숙지하십시오



**경고:** 감전 위험. 충전기 내부에 액체가 들어가지 않도록 충전하십시오. 감전될 수 있습니다.



**경고:** 정격 전류 전류가 30mA 미만인 누전 차단기를 사용하는 것이 좋습니다.



**주의:** 화상 위험. 신체 부상의 위험을 줄이려면 DeWALT 충전용 배터리로만 충전하십시오. 다른 유형의 배터리는 폭발로 인한 신체 부상과 손상을 초래할 수 있습니다.



**주의:** 어린이가 본 제품을 가지고 놀지 못하도록 항상 주시해야 합니다.

**참고:** 특정 조건에서, 충전기가 전원 공급기에 연결되어 있으면 충전기 내부에 노출된 충전 접점이 이물질에 의해 단락될 수 있습니다. 철부스리기, 알루미늄 호일, 금속 입자 축적물 등의 전도성 이물질은 충전기 캐비티에 닿지 않게 해야 합니다. 캐비티 안에 배터리 팩이 없을 경우 항상 배터리 전원 공급기에서 충전기의 플러그를 뽑으십시오. 충전기를 청소할 때는 플러그를 뽑아야 합니다.

- 본 사용 설명서에 명시된 충전기 외의 다른 충전기로 배터리 팩을 충전하지 마십시오. 본 충전기와 배터리 팩은 함께 사용하도록 특수 설계되었습니다.
- 이러한 충전기는 DeWALT 충전용 배터리 충전 이외의 용도로는 사용할 수 없습니다. 다른 용도로 사용하면 화재, 감전 또는 감전사고의 위험이 있습니다.
- 충전기가 비나 눈을 맞지 않도록 하십시오.
- 충전기를 분리할 경우 코드가 아니라 플러그를 뽑으십시오. 그래야만 전기 플러그 및 코드 손상의 위험이 줄어듭니다.
- 코드가 밟히거나 걸리거나 기타 원인에 의해 손상되거나 압박을 받지 않도록 유의하십시오.
- 불가피한 경우가 아니면 연장 코드를 사용하지 마십시오. 연장 코드를 잘못 사용하면 화재, 감전 또는 감전사의 위험이 있습니다.

- 충전기 위에 물건을 올려놓거나 부드러운 표면에 충전기를 두면 환기 슬롯이 막혀 내부가 과열될 수 있습니다. 충전기는 열원에 가까이 두지 마십시오. 충전기는 하우징의 상단과 하단에 있는 슬롯을 통해 환기됩니다.
- 코드가 플러그가 손상된 충전기를 작동시키지 마십시오 — 즉시 교체하십시오.
- 심한 충격을 받았거나 떨어뜨렸거나 어떠한 식으로든 손상된 경우에는 충전기를 작동시키지 마십시오. 공인 서비스 센터로 가져가십시오.
- 충전기를 분해하지 마십시오. 서비스나 수리가 필요한 경우에는 공인 서비스 센터로 가져가십시오. 잘못 재조립하면 감전, 감전사 또는 화재의 위험이 있습니다.
- 전원 코드가 손상된 경우 사고 방지를 위해 제조업체, 서비스 대리점 또는 이에 준하는 유자격 수리 기술자를 통해 즉시 교체하십시오.
- 충소하려면 먼저 충전기를 콘센트에서 분리하십시오. 그해야 감전 위험이 줄어듭니다. 배터리 팩을 제거하는 것만으로 이러한 위험이 줄어들지는 않습니다. 절대로 충전기 두 개를 함께 연결하지 마십시오.
- 충전기는 가정용 표준 전력 220-240V 으로 작동하도록 설계되어 있습니다. 다른 전압에서는 사용하지 마십시오. 차량용 충전기는 제외됩니다.

### 배터리 충전 (그림 B)

- 배터리 팩을 끼우기 전에 충전기를 적절한 콘센트에 꽂습니다.
- 충전기에 배터리 팩 **10** 을 끼우고 배터리 팩이 완벽히 장착되었는지 확인하십시오. 빨간색(충전 중) 표시등이 반복해서 깜박이면서 충전 프로세스가 시작되었음을 알립니다.
- 충전이 완료되면 빨간색 불이 계속 켜져 있습니다. 배터리 팩이 완전히 충전되면 바로 사용하거나 충전기에 그대로 둡니다. 배터리 팩을 충전기에 분리하려면, 배터리 팩에 있는 배터리 탈착 버튼 **11** 을 누릅니다.

**참고:** 리튬이온 배터리 팩의 성능과 수명을 극대화하려면 처음 사용하기 전에 배터리 팩을 완전히 충전시키십시오.

### 충전기 작동

배터리 팩의 충전 상태는 아래 표시등을 참조하십시오.

| 충전 표시등 |           |
|--------|-----------|
|        | 충전 중      |
|        | 완전 충전됨    |
|        | 냉/은 팩 지연* |

\*빨간색 표시등이 계속 깜박거리지만, 노란색 표시등은 이 작동동안 계속 켜져 있습니다. 배터리 팩이 적정 온도에 도달하면, 노란색 표시등이 꺼지고 충전기에서 충전 절차를 다시 시작합니다.

이 호환 충전기는 결함이 있는 배터리 팩은 충전하지 못합니다. 등이 켜지지 않도록 하여 배터리에 결함이 있음을 표시합니다.

**참고:** 이는 충전기 고장을 의미할 수도 있습니다.

충전기에 문제가 표시되는 경우 충전기와 배터리 팩을 공인 서비스 센터로 가져 가서 테스트를 받아 보십시오.

### 냉/은 팩 지연

충전기에서 너무 뜨겁거나 차가운 배터리 팩이 감지되면, 냉/은 팩 지연이 자동으로 시작되어 배터리 팩이 적절한 온도가 될 때까지 충전이 중단됩니다. 이 과정이 끝나면 충전기가 자동으로 팩 충전

모드로 전환됩니다. 이 기능은 배터리 팩 수명을 최대한으로 보장하기 위한 것입니다.

차가운 배터리 팩은 따뜻한 배터리 팩보다 더 느린 속도로 충전됩니다. 충전 사이클 전체에 걸쳐 배터리 팩은 이렇게 느린 속도로 충전되며 배터리 팩이 따뜻해지더라도 최대 충전 속도로 복원되지 않습니다.

DCB118충전기에는 배터리 팩을 식히기 위해 설계된 내장 팬이 장착되어 있습니다. 배터리 팩을 식혀야 하면 팬이 자동으로 켜집니다. 팬이 제대로 작동하지 않거나 환기구가 막혀 있을 경우 충전기를 작동하지 마십시오. 이물질이 충전기 내부로 들어가지 않도록 하십시오.

**전자 보호 시스템**

XR 리튬이온 배터리 팩은 배터리에 과부하가 걸리거나 과열 또는 완전 방전되는 것을 방지하는 전자 보호 시스템으로 설계되었습니다. 이 공구는 전자 보호 시스템이 작동하면 자동으로 꺼집니다. 이러한 경우 리튬 이온 배터리가 완전히 충전될 때까지 충전기에 리튬 이온 배터리 팩을 넣으십시오.

**벽 장착**

이들 충전기는 테이블 또는 작업 표면에 똑바로 세우거나 벽에 장착할 수 있도록 설계되었습니다. 벽에 장착하는 경우, 충전기는 전기 콘센트에 닿을 수 있는 범위 내에 놓고, 공기 흐름이 방해될 수 있는 코너 또는 기타 장애물로부터 멀리 두십시오. 벽에서 장착 나사의 위치는 견본으로 충전기의 뒤쪽을 사용하십시오. 나사 머리 직경이 7~9mm인 최소 25.4mm 길이의 석고보드 나사(별도 구매)를 사용해서 충전기를 단단히 장착하고, 노출된 나사의 약 5.5mm를 남겨 두고 최적의 길이로 목재에 고정합니다. 충전기 뒤쪽의 구멍을 노출되어 있는 나사에 맞추고 구멍에 완전히 맞물리도록 하십시오.

**충전기 청소 지침**

**경고: 감전 위험. 청소하려면 먼저 충전기를 AC 콘센트에서 분리하십시오.** 형감이나 부드러운 비금속성 브러시로 충전기 외관 부분에 묻은 먼지 및 기름을 제거할 수 있습니다. 물이나 세척제를 사용하지 마십시오. 공기 내부에 액체를 넣거나 공기 부품을 액체에 담그는 행동은 절대 금물입니다.

**배터리 팩**

**모든 배터리 팩에 대한 중요한 안전 지침**

배터리 팩을 교체하기 위해 주문할 때는 카탈로그 번호와 전압을 반드시 확인하고 표기해야 합니다.

배터리 팩은 포장박스에서 꺼낼 때 완전히 충전된 상태가 아닙니다. 배터리 팩과 충전기를 사용하기 전에 아래 안전 지침을 숙독하십시오. 그런 다음 설명된 충전 절차를 따르십시오.

**모든 지시 사항을 읽으십시오**

- **가연성 액체, 가스 또는 먼지 등 폭발 위험이 있는 환경에서 배터리를 충전하거나 사용하지 마십시오.** 배터리를 끼우거나 충전기에서 분리할 때 먼지나 가스에 불이 붙을 수 있습니다.
- **충전기에 배터리 팩을 끼울 때 과도한 힘을 주지 마십시오. 어떤 형태라도 호환되지 않는 충전기에 사용하기 위해 배터리 팩을 개조하지 마십시오. 배터리 팩이 파열되어 심각한 부상을 유발할 수 있습니다.**
- DeWALT 충전기에서만 배터리 팩을 충전하십시오.
- 물이나 기타 액체가 튀어 묻거나 액체에 빠지지 **않도록 하십시오.**
- 온도가 4 °C (39.2 °F) 이하로 떨어지거나 (겨울의 금속 외벽 또는 금속 건물과 같은) 장소에서 공구와 배터리 팩을 보관하거나

**사용하지 마십시오 40°C (104 °F) (여름철 더러운 창고 또는 금속 건물 등).**

- **배터리 팩이 심하게 손상되거나 완전히 낡았더라도 절대 소각하지 마십시오.** 배터리 팩은 불속에서 폭발할 수 있습니다. 리튬이온 배터리 팩은 연소되면서 독성 연기와 물질을 발생시킵니다.
- **배터리 내용물이 피부에 닿으면 즉시 중성 세척제로 해당 부위를 씻으십시오.** 배터리액이 눈에 들어갔을 경우, 15분 정도 또는 통증이 가실 때까지 눈을 뜨고 물로 씻어냅니다. 치료가 필요한 경우를 위해, 배터리 전해질은 액체 유기 탄산염과 리튬염의 혼합물로 구성되어 있음을 알아 두십시오.
- **열린 배터리 셀의 내용물은 호흡기 질환을 일으킬 수 있습니다.** 신선한 공기를 마시십시오. 증상이 계속되면 치료를 받으십시오.



**경고: 화상 위험.** 배터리액은 불꽃이나 화염에 노출되면 연소될 수 있습니다.



**경고: 어떤 이유로든 배터리 팩을 절대 분해하지 마십시오.** 배터리 팩 케이스가 깨지거나 손상되면 충전기에 넣지 마십시오. 배터리 팩을 뭉개거나 떨어뜨리거나 손상시키지 마십시오. 강한 충격을 받았거나, 떨어뜨렸거나, 차에 치였거나 기타의 원인으로 어떤 방식으로든 손상된 (못이 박히거나 망치로 맞았거나 밟힘) 배터리 팩이나 충전기는 사용하지 마십시오. 감전 또는 감전사의 위험이 있습니다. 손상된 배터리 팩은 재활용을 위해 서비스 센터에 반환해야 합니다.



**경고: 화재 위험. 배터리 팩을 보관하거나 휴대할 때는 노출된 배터리 단자에 금속 물체가 닿지 않도록 하십시오.** 예를 들어, 못, 나사, 키 등이 있는 알맞아, 주머니, 도구상자, 제품 키트 상자, 서랍 등에 배터리 팩을 두지 마십시오.



**주의: 사용하지 않는 공구는 걸려 넘어지거나 떨어질 위험이 없는 안정된 표면에 놓여 두십시오.** 배터리 팩이 큰 일부 공구들은 배터리 팩 위에 바로 서 있지만 쉽게 넘어질 수 있습니다

**운반**



**경고: 화재 위험.** 배터리를 운반할 때 배터리 단자가 실수로 전도성 물질과 닿을 경우 화재 위험의 가능성이 있습니다. 배터리를 운반할 경우에는 배터리 단자가 보호되어 있고, 물체에 닿을 경우 단락을 일으킬 수 있는 물체로부터 제대로 절연되어 있는지 확인하십시오.

**참고: 리튬이온 배터리는 검사된 수화물에 넣어 야 합니다.**

DeWALT 배터리는 UN의 위험물 운송에 관한 권고(Recommendations on the Transport of Dangerous Goods, RID/G), 국제 항공 운송 협회(IATA)의 위험물 규정, 국제해상위험물(International Maritime Dangerous Goods, IMDG) 규정 및 국제도로위험물품운송에 관한 유럽조약(European Agreement Concerning The International Carriage of Dangerous Goods by Road (ADR))을 포함하여 산업 표준 및 법적 기준에 따라 해당되는 모든 운송 규정을 준수합니다. 리튬 이온 전지 및 배터리는 위험 화물 테스트 및 기준 설명서에 대한 UN 권고 38.3항에 따라 테스트되었습니다.

대개의 경우, DeWALT 배터리 팩 해상 운송은 완전 규제를 받는 Class 9 위험 물질로 분류되는 것에서 제외됩니다. 일반적으로, 에너지효율 등급이 100 와트시 (Wh) 보다 큰 리튬 이온 배터리를 포함하는 수송물량 완전 규제를 받는 Class 9에 따라 운송되어야 합니다. 모든 리튬 이온 배터리에는 팩에 와트시 등급이 표시되어 있습니다. 뿐만 아니라, 규정의 복잡성으로 인해 DeWALT는 와트 시 등급에 상관 없이 리튬 이온 배터리 팩을 단독으로 항공 운송하는 것을 권장하지 않습니다. 배터리 팩의 와트시 등급이 100Whr 보다 크지 않을 경우는

제외되므로 배터리(콤보 키트)가 포함된 공구의 수송품은 항공 운송할 수 있습니다.

수송품이 예외로 고려되지 않거나 또는 완전 규제를 받든지 여부와 상관 없이, 포장, 라벨링/표시 및 문서 요건에 관한 최신 규정을 찾아보는 것은 운송 회사의 책임입니다.

설명서의 본 섹션에서 제공하는 정보는 옳다고 믿고 제공되며 문서가 작성되었던 시기에는 정확한 것으로 간주됩니다. 단, 보증은 명시적이거나 함축적으로 제공되지 않습니다. 활동 시 해당 규정을 준수하는 것은 구매자의 책임입니다

**FLEXVOLT™ 배터리 운반**

DeWALT FLEXVOLT™ 배터리에는 두 개의 모드, 즉 **사용** 및 **운반**이 있습니다.

**사용 모드:** FLEXVOLT 배터리는 18V (20V Max) 제품에 체결 할 경우 18V (20V Max) 전압으로 작동되며, 54V (60V Max) 제품에 체결 할 경우 54V (60V Max) 전압으로 작동이 됩니다.

또는 108V (120V Max) 제품에 플렉스볼트 배터리 2 개를 체결 할 경우 108V (120V Max) 전압으로 작동이 됩니다.

**운반 모드:** 캡이 FLEXVOLT™ 배터리에 장착되어 있으면, 배터리는 운반 모드에 있는 것입니다. 운송 시 캡을 유지하십시오.

운반 모드에 있을 때, 더 높은 와트시 등급의 배터리 1 개에 비해 더 낮은 와트시(Wh) 등급의 배터리 3 개가 되는 팩 내에서 일련의 셀은 전기 연결이 끊어져 있습니다. 와트시 등급이 더 낮은 이 증가된 배터리 3 개 수량은 더 높은 와트시 배터리에 부과되는 특정 수송 규정에서 팩을 면제시킬 수 있습니다.

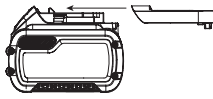

예를 들어, 운반 Wh 정격은 사용 및 운반 라벨 표시의 예 3 x 36 Wh를 나타내며, 각 36 Wh 배터리 3 개를 의미합니다. 사용 Wh 정격은 108 Wh를 나타낼 수 있습니다(1개 배터리 포함).

Use: 108 Wh  
Transport: 3x36 Wh

**보관 권장 사항**

- 보관 장소로는 직사광선을 받지 않고 지나치게 덥거나 춥지 않은 시원하고 건조한 곳이 가장 좋습니다. 최적의 배터리 성능과 수명을 위해, 사용하지 않을 때에는 배터리 팩을 실온에서 보관하십시오.
- 장기간 보관하는 경우, 최적의 결과를 위해 완전히 충전된 배터리 팩을 충전기에서 분리하여 서늘하고, 건조한 장소에 보관하는 것이 좋습니다.

**참고:** 배터리 팩은 완전히 방전된 상태로 보관해서는 안됩니다. 사용 전에 배터리 팩을 재충전해야 합니다.

**충전기 및 배터리 팩에 부착된 라벨**

본 설명서에 사용된 그림 외에도 충전기 및 배터리 팩에 부착된 라벨에는 다음과 같은 그림이 표시되어 있습니다.



사용 전에 사용 설명서의 내용을 숙지하십시오.



충전 시간은 **기술 데이터를** 참조하십시오.



전도성 있는 물체로 시험하지 마십시오.



손상된 배터리 팩을 충전하지 마십시오.



물에 닿지 않도록 하십시오.



손상된 코드는 즉시 교체하십시오.



4°C ~ 40°C 사이에서만 충전하십시오.



실내 전용.



환경 보호 차원에서 배터리 팩을 폐기하십시오.

**Li-Ion**



지정된 DeWALT 충전기뿐만 DeWALT 배터리 팩을 충전하십시오. DeWALT 충전기에 지정된 DeWALT 배터리 이외의 배터리 팩을 충전하면 폭발하여 다른 위험한 상황으로 이어질 수 있습니다.



배터리 팩을 소각하지 마십시오.



사용(운반 캡 미포함). 예: Wh 정격은 108 Wh 를 나타냅니다(108 Wh 배터리 1 개).



운반(내장 운반 캡 포함). 예: Wh 정격은 3 x 36 Wh (36 Wh 배터리 3 개)를 나타냅니다.

**배터리 유형**

다음 공구는 18 (20 Max)볼트 배터리 팩에서 작동합니다. DCG409 이러한 배터리 팩은 다음을 사용할 수 있습니다. DCB181, DCB182, DCB183, DCB183B, DCB184, DCB184B, DCB185, DCB186, DCB187, DCB189, DCB203, DCB204, DCB205, DCB240, DCB546, DCB547, DCB548, DCB606, DCB609, DCB612. 자세한 정보는 **기술 데이터를** 참조하십시오.

**포장 내용물**

포장에는 다음 내용물이 들어 있습니다.

- 1 앵글 그라인더
- 1 125mm 가드 (유형 27)
- 1 측면 손잡이
- 1 육각 렌치
- 1 충전기
- 1 리튬 이온 배터리 팩 (C1, D1, L1, M1, P1, S1, T1, X1, Y1 모델)
- 1 리튬 이온 배터리 팩 (C2, D2, L2, M2, P2, S2, T2, X2, Y2 모델)
- 1 리튬 이온 배터리 팩 (C3, D3, L3, M3, P3, S3, T3, X3, Y3 모델)
- 1 사용 설명서

**참고:** 배터리 팩, 충전기 및 키트 박스는 N 모델에 포함되어 있지 않습니다. 배터리 팩과 충전기는 NT 모델에 포함되어 있지 않습니다. B 모델에는 Bluetooth® 배터리 팩이 포함됩니다.

**참고:** Bluetooth® 워드 마크 및 로고는 Bluetooth®, SIG, Inc. 소유의 등록 상표이며 DeWALT의 이러한 마크 사용은 라이선스하에 있습니다. 기타 상표 및 상호는 해당 소유자의 자산입니다.

- 운반 중에 발생할 수 있는 공구, 부품 또는 액세서리의 손상 여부를 확인하십시오.
- 작동 전에 시간을 내어 본 사용 설명서를 읽고 숙지하십시오.

## 공구에 표시된 마크

공구에는 다음과 같은 그림이 있습니다.



사용 전에 사용 설명서의 내용을 숙지하십시오.



귀 보호 장구를 착용하십시오.



보안경을 착용하십시오.

## 날짜 코드 위치 (그림 E)

날짜 코드에는 **12**, 제조년도가 포함되어 이 제조년도는 케이스에 인쇄되어 있습니다.

예:

2021 XX XX  
제조 연도 및 주

## 설명 (그림 A)



**경고:** 전동 공구 또는 전동 공구의 어떤 부품도 절대 개조하지 마십시오. 제품이 파손되거나 신체 부상을 당할 수도 있습니다.

- 1 보조 핸들 핸들
- 2 잠금 레버
- 3 스팀들 잠금 버튼
- 4 스팀들
- 5 측면 손잡이
- 6 백업 플랜지
- 7 잠금 플랜지
- 8 가드
- 9 가드 분리 레버
- 10 배터리 팩
- 11 배터리 분리 버튼

## 용도

DCG409 무선 앵글 그라인더는 전문적인 연삭, 샌딩 및 와이어 브러시 적용을 위해 설계되었습니다.

**절대로 습한 환경이나 가연성 액체 또는 가스가 있는 곳에서 사용하지 마십시오.**

이 무선 앵글 그라인더는 전문적인 파이프 톨입니다.

**어린이가 이 공구를 만지지 않도록 하십시오.** 경험이 없는 작업자가 이 공구를 사용할 때는 감독자의 지도가 필요합니다.

- **어린이 및 노약자. 본 제품은 어린이나 노약자가 사용하도록 설계되지 않았습니다.** 이러한 사람이 사용할 때는 감독이 필요합니다.
- 본 제품은 안전 책임을 맡고 있는 사람이 감독을 하고 있지 않는 한 경험, 지식 또는 기술이 부족하고 신체적, 감각적 또는 정신적 능력이 미약한 사람(어린이 포함)이 사용하도록 고안된 것이 아닙니다. 이 제품과 함께 어린이만 혼자 두어서는 안됩니다.

## 기능

### 무 전압 스위치

무 전압 기능은 전원 공급 장치에 단선이 있는 경우 스위치를 순환하지 않고 그라인더 재시작을 중지합니다.

### 전자 클러치

이 장치에는 E-Clutch™ (전자 클러치)가 장착되어 있어 고부하 또는 휠 핀치시 장치가 차단되어 사용자의 반응 토크를 줄입니다. 공구를 다시 작동하려면 스위치를 껐다가 켜야 합니다.

### 킥백 브레이크™

핀치, 실속 또는 바인드 업 이벤트가 감지되면 전자 브레이크가 최대 힘으로 맞물려 휠을 빠르게 멈추고 그라인더의 움직임을 줄이고 그라인더를 끕니다. 공구를 다시 작동하려면 스위치를 놓은 다음 눌러야 합니다.

### Power-OFF™ 과부하 보호

모터 과부하시 모터에 대한 전원 공급이 감소됩니다. 모터 과부하시 모터에 대한 전원 공급이 감소됩니다. 공구를 다시 작동하려면 스위치를 놓은 다음 눌러야 합니다. 공구는 전류 부하가 과부하 전류 값 (모터 연소 점)에 도달 할 때마다 전원을 끕니다. 지속적인 과부하 차단이 발생하면 과부하가 걸리지 않고 공구가 작동 할 때까지 공구에 더 적은 힘 / 무게를 가하십시오.

### 소프트 스타트 기능

소프트 스타트 기능은 시작시 초기 저크를 방지하기 위해 저속 빌드 업을 허용합니다. 이 기능은 제한된 공간에서 작업 할 때 특히 유용합니다.

### 방진 사이드 핸들

진동 방지 측면 핸들은 공구로 인한 진동을 흡수하여 추가적인 편안함을 제공합니다.

### 조립 및 조정



**경고: 심각한 신체 부상의 위험을 줄이려면 공구를 정하거나 부착물 또는 액세서리를 제거/설치하기 전에 공구를 끄고 배터리 팩을 분리하십시오.** 공구가 갑자기 작동하여 부상을 당할 수 있습니다.



**경고: DeWALT 배 터리 팩과 충전기만 사용하십시오.**

## 배터리 팩 삽입 및 공구에서 배터리 팩 분리 (그림 B)

참고: 배터리 **10** 이 완전히 충전되었는지 확인하십시오.

### 배터리 팩을 공구 핸들에 설치하려면

1. 공구 핸들 안쪽의 레일에 배터리 팩 **10** 을 맞추니다 (그림 B).
2. 공구에 배터리 팩이 견고하게 장착될 때까지 핸들에 밀어 넣고 딸깍하고 잠기는 소리가 들리는지 확인하십시오.

### 공구에서 배터리 팩을 분리하려면

1. 탈착 버튼 **11** 을 누르고 배터리 팩을 공구 핸들에서 완전히 빼냅니다.
2. 본 사용 설명서의 충전기 섹션에 설명된 대로 배터리 팩을 충전기에 삽입합니다.

## 잔량표시계 배터리 팩 (그림 C)

일부 DeWALT 배터리 팩에는 배터리 팩의 남아 있는 충전 레벨을 표시하는 세 개의 녹색 LED 등으로 구성된 연료계가 포함되어 있습니다.

잔량표시계를 작동시키려면 **19** 을, 잔량표시계 버튼 누릅니다. 녹색 LED 표시등 3 개가 조합되어 커짐으로써 충전 잔량 수준을 나타냅니다. 배터리 잔량이 사용 가능한 한계치 미만이면 배터리 잔량 표시계가 켜지지 않으므로 배터리를 재충전해야 합니다.

**참고:** 잔량표시계는 배터리 팩에 남아 있는 충전 레벨을 나타내는 것일 뿐입니다. 공구의 기능성을 나타내는 것이 아니며 제품 구성품, 온도 및 최종 사용자의 용도에 따라 변경될 수 있습니다.

## 측면 손잡이 부착 (그림 C)

**경고:** 공구를 사용하기 전에 핸들이 단단히 조여졌는지 확인하십시오.

측면 손잡이 **5** 를 기어 케이스 양쪽의 구멍 중 하나에 단단히 조이십시오. 항상 사이드 컨트롤을 사용하여 공구 제어를 유지해야 합니다.

## 기어 케이스 회전 (그림 D)

사용자 편의를 개선하기 위해 기어 케이스가 작업을 위해 90° 회전합니다.

1. 기어 케이스를 모터 하우징에 부착하는 모서리 나사 4 개를 분리합니다.
2. 기어 하우징을 모터 하우징에서 분리하지 않고 기어 케이스 헤드를 원하는 위치로 돌립니다.

**참고:** 기어 케이스와 모터 하우징이 3.17mm 이상 분리 된 경우 공인 DeWALT 서비스 센터에서 공구를 정비하고 재 조립해야 합니다. 공구를 수리하지 않으면 모터 및 베어링 고장이 발생할 수 있습니다.

3. 기어 케이스를 모터 하우징에 부착하려면 나사를 다시 설치하십시오. 나사를 12.5 in.-lbs. 토크로 조입니다. 너무 세게 조이면 나사가 벗겨 질 수 있습니다.

## 가드

**경고:** 가드는 모든 그라인딩 휠, 휠, 샌딩 플랩 디스크, 와이어 브러시 및 와이어 휠과 함께 사용해야 합니다. 공구는 기존 샌딩 디스크로 샌딩할 때만 가드없이 사용할 수 있습니다. 장치와 함께 제공된 보호대를 확인하려면 그림 A를 참조하십시오. 일부 어플리케이션은 지역 판매점이나 공인 서비스 센터에서 올바른 보호대를 구입해야 할 수도 있습니다.

**참고:** 예치 그라인딩 목적을 위해 설계 및 지정된 타입 27 휠로 수행할 수 있습니다. 6.35mm 두께의 휠은 표면 연삭 용으로 설계되었으며 더 얇은 Type 27 휠은 표면 연삭 또는 예치 연삭에만 사용할 수 있는지 제조업체 라벨에서 확인해야 합니다. 표면 연삭이 금지 된 휠에는 유형 1 가드를 사용해야 합니다. 유형 41 휠과 유형 1 가드를 사용하여 작업을 수행할 수도 있습니다.

**참고:** 적절한 가드 / 액세서리 조합을 선택하려면 **액세서리 차트**를 참조하십시오.

## 원 터치™ 가드 장착 및 조정 (그림 E)

**경고:** 심각한 신체 부상의 위험을 줄이려면 공구를 정하거나 부활을 또는 액세서리를 제거/설치하기 전에 공구를 끄고 배터리 팩을 분리하십시오. 공구가 갑자기 동하여 부상을 당할 수 있습니다.

## 가드 조정

가드 조정을 위해, 가드 해제 레버 **9** 는 래치 기능을 사용하여 가드 칼라의 정렬 구멍 **15** 중 하나와 맞물립니다.

맞물림은 기울어져 있으며 가드가 시계 방향 (스핀들이 사용자를 향함)으로 회전 할 때 다음 정렬 구멍으로 넘어가지만 시계 반대 방향으로 지동 고정됩니다.

## 가드 장착 (그림 E)

1. 가드 해제 레버 **9** 를 누르십시오.
  2. 가드 해제 레버를 연 상태에서 가드의 러그 **13** 를 기어 케이스의 슬롯 **14** 에 맞춥니다.
  3. 가드 해제 레버를 연 상태에서 가드 러그가 맞 물릴 때까지 가드를 아래로 밀어서 기어 케이스 허브의 홈에서 돌립니다. 가드 분리 레버를 분리하십시오.
  4. 스펀들이 작업자를 향한 상태에서 가드를 시계 방향으로 원하는 작업 위치로 돌립니다. 가드 해제 레버 **9** 를 누른 상태로 가드를 시계 반대 방향으로 돌립니다.
- 참고:** 가드 바디는 스펀들과 작업자 사이에 배치되어 작업자를 최대한 보호해야 합니다. 가드 해제 레버는 가드 칼라의 정렬 구멍 **15** 중 하나에 끼워져야 합니다. 이렇게 하면 가드가 고정됩니다.
5. 가드를 제거하려면 이 지침의 1-3 단계를 반대로 수행하십시오.

## 플랜지와 휠

### 비 허브 휠 장착 (그림 F)

**경고:** 플랜지 / 클램프 너트 / 휠을 올바르게 장착하지 않으면 심각한 부상을 입거나 공구 또는 휠이 손상될 수 있습니다.

**주의:** 동봉 된 플랜지는 가운데 27 형 및 42 형 연삭 휠 및 1 형 및 41 형 휠과 함께 사용해야 합니다. 자세한 내용은 **액세서리 차트**를 참조하십시오.

**경고:** 휠을 사용할 때는 단단한 양면 휠 가드가 필요합니다.

**경고:** 손상된 플랜지 또는 가드를 사용하거나 올바른 플랜지를 사용하지 않으면 휠 파손 및 휠 접촉으로 인해 부상을 입을 수 있습니다. 자세한 내용은 **액세서리 차트**를 참조하십시오.

1. 도구를 테이블 위에 놓고 조심하십시오.
2. 중앙 (파이릿)이 휠을 향하도록 하여 스펀들 **4** 에 지지 플랜지 **6** 을 설치합니다. 백킹 플랜지를 제거리에 누릅니다.
3. 백킹 플랜지의 돌출 된 중앙 (파이릿)을 중심으로 휠을 **20** 백킹 플랜지에 대십시오.
4. 스펀들 잠금 버튼을 누르고 육각 홈이 휠에서 먼 쪽을 향하게 하면서 러그가 스펀들의 두 슬롯에 맞물 리도록 스펀들에 잠금 플랜지 **7** 을 끼웁니다.
5. 스펀들 잠금 버튼을 누른 상태에서 손으로 또는 제공된 렌치를 사용하여 잠금 플랜지 **7** 을 조입니다. (완벽한 상태 인 경우에만 잠금 플랜지를 사용하십시오.) 플랜지 세부 사항을 보려면 **액세서리 차트**를 참조하십시오.
6. 휠을 제거하려면 위의 절차를 반대로 수행하십시오.

### 마운팅 샌딩 백킹 패드 (그림 G)

**참고:** 파이버 수지 디스크라고도 하는 백킹 패드를 사용하는 샌딩 디스크와 함께 보호대를 사용할 필요는 없습니다. 이러한 액세서리에는 보호대가 필요하지 않으므로 사용하면 보호대가 올바르게 맞지 않을 수 있습니다.



**경고:** 플랜지 / 클램프 너트 / 휠을 올바르게 장착하지 않으면 심각한 부상을 입거나 공구 또는 휠이 손상될 수 있습니다.



**경고:** 샌딩 작업이 완료된 후 그라인딩 휠, 휠, 샌딩 플랩 디스크, 와이어 브러시 또는 와이어 휠 애플리케이션을 위해서는 로퍼 가드를 다시 설치해야 합니다.

- 스핀들에 지지 패드 **17** 를 놓거나 적절하게 끼웁니다.
- 샌딩 디스크 **18** 를 지지 패드 **17** 에 놓습니다.
- 스핀들 잠금 **3** 을 누른 상태에서 클램프 너트 **16** 를 스팀들에 끼우면서 클램프 너트의 올린 허브를 샌딩 디스크 및 백업 패드의 중앙으로 파일럿하십시오.
- 클램프 너트를 손으로 조입니다. 그런 다음 샌딩 디스크와 클램프 너트가 꼭 맞을 때까지 샌딩 디스크를 돌리면서 스팀들 잠금 버튼을 누르십시오.
- 휠을 제거하려면 스팀들 잠금 버튼을 누른 상태에서 백킹 패드와 샌딩 패드를 잡고 돌립니다.

### 허브 휠 장착 및 제거 (그림 F)

허브 휠은 나사 스팀들에 직접 설치됩니다. 액세서리 스프레드는 스팀들 스프레드와 일치해야 합니다.

- 공구에서 잡아 당겨지지 플랜지를 제거하십시오.
- 스핀들 **4** 에 휠을 손으로 끼웁니다.
- 스핀들 잠금 버튼 **3** 을 누르고 렌치를 사용하여 휠 허브를 조이십시오.
- 휠을 제거하려면 위의 절차를 반대로 하십시오.  
**주의:** 공구 전원을 켜기 전에 휠을 올바르게 장착하지 않으면 공구 또는 휠이 손상될 수 있습니다.

### 와이어 컵 브러시 및 와이어 휠 장착 (그림 A)



**경고:** 플랜지 / 클램프 너트 / 휠을 올바르게 장착하지 않으면 심각한 부상을 입거나 공구 또는 휠이 손상될 수 있습니다.



**주의:** 부상의 위험을 줄이려면 와이어 브러시와 휠을 다룰 때 작업용 장갑을 착용하십시오. 날카로워질 수 있습니다.



**주의:** 공구 손상 위험을 줄이려면 장착시 또는 사용중에 휠 또는 브러시가 가드에 닿아서는 안됩니다. 액세서리에 갇힐 수 없는 손상이 발생하여 액세서리 휠 또는 컵에서 전선이 부러질 수 있습니다.

와이어 컵 브러시 또는 와이어 휠은 플랜지를 사용하지 않고 나사 스팀들에 직접 설치됩니다. 나 사형 허브와 함께 제공된 와이어 브러시 또는 휠만 사용하십시오. 이 액세서리는 현지 판매점이나 공인 서비스 센터에서 추가 비용으로 구입할 수 있습니다.

- 도구를 테이블 위에 놓고 조심하십시오.
- 스핀들에 휠을 손으로 끼웁니다.
- 스핀들 잠금 버튼 **3** 을 누르고 와이어 휠 또는 브러시 허브의 렌치를 사용하여 휠을 조이십시오.
- 휠을 제거하려면 위 절차를 반대로 수행하십시오.  
**주의:** 공구 손상 위험을 줄이려면 공구를 켜기 전에 휠 허브를 올바르게 장착하십시오.

### 작동을 하기 전에

- 가드와 적절한 디스크 또는 휠을 설치하십시오. 마모가 심한 디스크 나 휠은 사용하지 마십시오.
- 광택용 패드가 정확하게 장착되었는지 확인하십시오. 액세서리 차트에 제공된 지침을 따르십시오.

- 패드와 액세서리 및 공구의 화살표 방향으로 회전하도록 하십시오.
- 손상된 액세서리는 사용하지 마십시오. 매번 사용하기 전에 연마 휠에 칩 및 균열이 있는지, 백킹 패드에 균열이 있는지, 찢어 지거나 과도한 마모가 있는지, 와이어 브러시가 느슨하거나 갈라진 와이어가 있는지 점검하십시오. 전동 공구나 액세서리를 떨어뜨린 경우에는 손상된 부분이 없는지 검사하고 손상된 부분이 있을 경우 손상되지 않은 액세서리를 설치하십시오. 액세서리를 검사 및 설치한 뒤 회전하는 액세서리 작업대에서 멀리 거리를 유지하고 전동 공구를 1분 간헐적 무부하 속도로 작동시키십시오. 액세서리가 손상된 경우 보통 이 테스트 중에 떨어져 나갑니다.

### 조작

#### 사용 지침



**경고:** 항상 안전 지시 사항과 해당 규정을 준수하십시오.



**경고:** 심각한 신체 부상의 위험을 줄이려면 공구를 정하거나 부착물 또는 액세서리를 제거/설치하기 전에 공구를 끄고 배터리 팩을 분리하십시오. 공구가 갑자기 동하여 부상을 당할 수 있습니다.

#### 올바른 손의 위치 (그림 H)



**경고:** 심각한 신체 부상의 위험을 줄이려면 항상 그림과 같이 올바르게 손을 위치하십시오.



**경고:** 심각한 신체 부상의 위험을 줄이려면 항상 급작스러운 반동을 예상하고 확실하게 잡으십시오.

올바른 손 위치는 그림 H와 같이 한 손은 측면 핸들 **5** 에, 다른 손은 보조 핸들에 있어야 합니다

#### 슬라이더 스위치 (그림 A)



**경고:** 공구를 작동할 때와 사용 중 또는 휠 또는 액세서리의 회전이 멈출때까지 공구의 측면 핸들과 본체를 단단히 잡으십시오. 공구를 내려 놓기 전에 휠이 완전히 멈춘는지 확인하십시오.

**참고:** 예기치 않은 공구 이동을 줄이려면 부하 상태에서 공구를 켜거나 끄지 마십시오. 작업 표면에 닿기 전에 그라인더가 최대 속도로 작동하도록 하십시오. 공구를 끄기 전에 표면에 공구를 들어 올리십시오. 공구를 내려 놓기 전에 공구가 회전을 멈출 때까지 기다리십시오.



**경고:** 공구를 전원 공급 장치에 연결하기 전에 스위치 뒷면을 눌렀다 놓아 슬라이더 스위치가 꺼진 위치에 있는지 확인하십시오. 방전 된 배터리와 같이 공구에 대한 전원 공급이 중단 된 후 위에서 설명한대로 슬라이더 스위치가 꺼진 위치에 있는지 확인하십시오.

공구를 작동하려면 ON / OFF 슬라이더 스위치 **1** 을 공구 앞쪽으로 밀니다. 공구를 중지하려면 ON / OFF 슬라이더 스위치를 놓습니다. 연속 작동을 위해서는 스위치를 공구 앞쪽으로 밀고 스위치의 앞쪽 부분을 안쪽으로 누르십시오. 연속 모드에서 작동하는 동안 공구를 중지하려면 슬라이더 스위치의 뒤쪽 부분을 눌렀다 놓습니다.

#### 스핀들 잠금 장치 (그림 I)

휠을 설치하거나 제거 할 때 스팀들이 회전하지 않도록 스팀들 잠금 장치 **3** 가 제공됩니다. 공구를 끄고 전원 공급 장치에서 분리 한 후 완전히 정지 한 경우에만 스팀들 잠금 장치를 작동하십시오.



**참고:** 공구 손상 위험을 줄이려면 공구가 작동하는 동안 스펠을 잠금 장치를 사용하지 마십시오. 공구가 손상되어 부속 액세서리가 떨어져 부상을 입을 수 있습니다.

잠금 장치를 잠그려면 스펠을 잠금 버튼 누르고 스펠들이 더 회전할 수 없을 때까지 스펠들을 돌리십시오.

## 표면 연삭, 샌딩 및 와이어 브러싱

**!** 주의: 이 설명서의 지침에 따라 항상 올바른 보호대를 사용하십시오.

공작물 표면에서 작업을 수행하려면 :

1. 공구를 작업대에 달기 전에 공구가 최고 속도에 도달하도록 하십시오.
2. 작업 표면에 최소 압력을 가하여 공구가 고속으로 작동하도록 합니다. 공구가 고속으로 작동 할 때 재료 제거율이 가장 높습니다.
3. 공구와 작업면 사이에 적절한 각도를 유지하십시오. 특정 기능에 따라 차트를 참조하십시오.

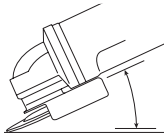

| 기능           | 각도      |
|--------------|---------|
| 연마           | 20°-30° |
| 플랩 디스크로 샌딩   | 5°-10°  |
| 백킹 패드가 있는 샌딩 | 5°-15°  |
| 와이어 브러싱      | 5°-10°  |

4. 휠의 가장자리와 작업면 사이의 접촉을 유지하십시오.
  - 연삭, 플랩 디스크 또는 와이어 브러싱으로 샌딩하는 경우 작업면에 가루징이 발생하지 않도록 공구를 앞뒤로 계속 움직입니다.
  - 백킹 패드로 샌딩하는 경우 작업 표면이 타거나 타지 않도록 공구를 일직선으로 계속 움직이십시오.

**참고:** 공구를 움직이지 않고 작업대에 두면 작업물이 손상됩니다.

5. 공구를 끄기 전에 작업대에서 공구를 제거하십시오. 공구를 내려 놓기 전에 회전을 멈추십시오.

**!** 주의: 그라인더가 갑자기 날카로워질 수 있으므로 가장자리 위로 작업할 때는 특히 주의하십시오.

## 도장 된 공작물 작업시 주의사항

1. 오염 된 먼지를 제거하기 어렵기 때문에 납 기반 페인트의 샌딩 또는 와이어 브러싱은 권장되지 않습니다. 납 중독의 가장 큰 위험은 어린이와 임산부에게 있습니다.
2. 화학 분석없이 페인트에 납이 포함되어 있는지 여부를 식별하기 어렵기 때문에 페인트를 샌딩할 때 다음 예방 조치를 권장합니다:

### 신체 안전 사항

1. 어린이나 임산부는 모든 청소가 완료 될 때까지 페인트 샌딩 또는 와이어 브러싱이 수행되는 작업장에 출입해서는 안됩니다.
2. 작업 구역에 들어가는 모든 사람은 방진 마스크 또는 마스크를 착용해야 합니다. 필터는 매일 또는 착용자가 호흡 곤란을 겪을때마다 교체해야 합니다.

**참고:** 납 페인트 분진 및 연기 작업에 적합한 먼지 마스크만 사용해야 합니다. 일반 도장 마스크는 이 보호 기능을 제공하지

않습니다. 적절한 N.I.O.S.H. 승인 마스크에 대해서는 현지 하드웨어 판매점에 문의하십시오.

3. 오염 된 페인트 입자의 섭취를 방지하기 위해 작업장에서 음식물, 음료수 또는 담배를 피우지 마십시오. 근로자는 음식을 먹거나 마시거나 흡연하기 전에 씻고 청소해야 합니다. 음식, 음료 또는 흡연 물품은 먼지가 쌓일수 있는 작업 공간에 두지 않아야 합니다.

### 환경 안전

1. 분진 발생을 최소화하기 위해 페인트를 제거해야 합니다.
2. 페인트 제거가 발생하는 부분은 4 밀 두께의 플라스틱 시트로 밀봉해야 합니다.
3. 샌딩 작업 영역 외부의 페인트 먼지 축적을 줄이기 위해 수행해야 합니다.

### 청소 및 폐기

1. 작업 영역의 모든 표면은 샌딩 프로젝트 기간 동안 매일 진공 청소하고 철저히 청소해야 합니다. 진공 필터 백은 자주 교체해야 합니다.
2. 플랩 디스크 천은 먼지 침이나 기타 제거 파편과 함께 모아서 처리해야 합니다. 밀폐 된 쓰레기통에 보관하고 정기적인 쓰레기 수거 절차를 통해 처리해야 합니다. 청소하는 동안 어린이와 임산부는 작업장에서 멀리 떨어져 있어야 합니다.
3. 어린이가 사용하는 모든 장난감, 빨수 있는 가구 및 기구는 다시 사용하기 전에 철저히 씻어야 합니다.

## 가장자리 연삭

**!** 경고: 표면 연삭 작업에는 에지 연삭 휠을 사용하지 마십시오. 이 휠은 표면 연삭시 발생하는 측면 압력에 적합하지 않습니다. 휠이 파손되어 부상을 입을 수 있습니다.

**!** 주의: 공구를 사용하는 동안 모서리 연삭에 사용되는 휠이 휘거나 뒤로될 경우 휠이 부러지거나 반동될 수 있습니다. 모든 모서리 연삭 작업에서 가드의 열린 쪽이 작업자로부터 떨어져 있어야 합니다.

**참고:** 유형 27 휠을 사용한 엣지 그라인딩/컷팅은 휠이 새것일 때 깊이 13mm 미만의 알은 노칭으로 제한되어야 합니다. 휠이 마모될 때 휠 반경이 줄어드는것과 같이 노치 깊이를 줄이십시오. 자세한 내용은 액세서리 차트를 참조하십시오. 타입 1 휠로 에지 연삭을 하려면 타입1 가드를 사용해야 합니다.

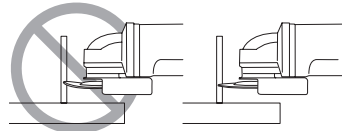

1. 공구를 작업대에 달기 전에 공구가 최고 속도에 도달하도록 하십시오.
2. 작업 표면에 최소 압력을 가하여 공구가 고속으로 작동하도록 합니다. 공구가 고속으로 작동할 때 연삭 속도가 가장 높습니다.
3. 휠의 아래쪽이 사용자를 향하지 않도록 작업자 위치를 배치하십시오.
4. 작업이 시작되고 공작물에 노치가 설정되면 각도를 변경하지 마십시오. 각도를 변경하면 휠이 구부러져 휠이 파손될 수 있습니다. 모서리 연삭 휠은 굽힘으로 인한 측면 압력을 견디도록 설계되지 않았습니다.

5. 공구를 끄기 전에 작업대에서 공구를 제거하십시오. 공구를 내려 놓기 전에 회전을 멈추십시오.

## 금속 어플리케이션

금속 응용 분야에서 공구를 사용할 때는 금속 부스러기로 인한 잔류 위험을 피하기 위해 잔류 전류 장치(RCD)가 삽입되어 있는지 확인하십시오.

RCD에 의해 전원 공급 장치가 차단 된 경우 공인 DeWALT 수리 대리점에 의뢰하십시오.

**경고:** 극한의 작업 조건에서 금속으로 작업 할 때 전도성 먼지가 장비 하우징 내부에 쌓일 수 있습니다. 감전의 위험이 있으므로 기계의 보호 절연 성능이 저하될 수 있습니다. 기계 내부에 금속 부스러기가 쌓이지 않도록하려면 환기 슬롯을 매일 청소하는 것이 좋습니다. **유지 보수** 매뉴얼을 참조하십시오.

## 금속 작업

**접착 연마제로 작업할 때는 항상 가드 타입 1을 사용하십시오.**

작업시, 재료에 맞게 적당한 피드로 작업하십시오. 디스크에 압력을 가하거나 기계를 기울이거나 진동시키지 마십시오.

측면 압력을 가하여 디스크의 속도를 낮추지 마십시오.

기계는 항상 상용 동작으로 작동해야 합니다. 그렇지 않으면 작업되지 않은 상태로 밀어넣을 위험이 있습니다.

프로파일과 사각형 막대를 작업할때는 가장 작은 단면에서 시작하는것이 가장 좋습니다.

## 거친 연삭

**황삭에는 절대로 디스크를 사용하지 마십시오.**

**항상 가드 유형 27을 사용하십시오.**

기계를 30° ~ 40°의 각도로 설정하면 최상의 황삭 결과를 얻을 수 있습니다. 적당한 압력으로 기계를 앞뒤로 움직입니다. 이러한 방식으로, 공작물이 너무 뜨거워지지 않고 변색되지 않으며 흠이 형성되지 않습니다.

## 석재 작업

기계는 건식 작업에만 사용해야 합니다.

석재 작업에는 다이아몬드 디스크를 사용하는 것이 가장 좋습니다. 먼지 방지 마스크를 추가하여 기계를 작동하십시오.

## 작업 안내사항

**구조 벽의 슬롯을 작업할 때는 주의하십시오.**

구조 벽의 슬롯에는 국가 별 규정이 적용됩니다. 이러한 규정은 모든 상황에서 준수해야 합니다. 작업을 시작하기전에 담당 구조 엔지니어, 건축가 또는 건축 감독자와 상의하십시오.

## 유지 보수

DeWALT 전동 공구는 최소한의 유지 보수로 장기간에 걸쳐 작업이 가능하도록 설계되어 있습니다. 만족스러운 연속 작동은 적절한 공구 관리와 정기적인 청소에 따라 그 성능이 달라질 수 있습니다.

**경고: 심각한 신체 부상의 위험을 줄이려면 공구를 정하거나 부작용 또는 액세서리를 제거/설치하기 전에 공구를 끄고 배터리 팩을 분리하십시오. 공구가 갑자기 작동하여 부상을 당할 수 있습니다.**

충전기 및 배터리 팩은 수리할 수 없습니다.



## 윤활방법

전동 공구는 별도의 윤활 작업이 필요하지 않습니다.



## 청소

**경고:** 통풍구 속이나 주변에 먼지가 쌓여있는 것이 보이면 가능한 한 자주 건조한 공기를 이용하여 메인 하우징에서 먼지를 불어내십시오. 이 절차를 수행할 때에는 승인된 눈 보호 장구 및 승인된 방진 마스크를 착용하십시오.

**경고:** 공구의 비금속성 부품을 청소할 때는 용제 등의 강력한 화학약품을 절대 사용하지 마십시오. 그렇지 않으면 이러한 부분에 사용된 재료가 약해질 수 있습니다. 헹굼에 물과 순한 비누를 적서 닦아주십시오. 공구 내부에 액체를 넣거나 공구 부품을 액체에 담그는 행동은 절대 금물입니다.

## 선택 액세서리

**경고:** DeWALT에서 제공하지 않은 액세서리는 본 제품에서 테스트되지 않았으므로 본 제품에서 이러한 액세서리를 사용하면 위험할 수 있습니다. 신체 부상의 위험을 줄이려면 본 제품에 알맞은 액세서리만 사용해야 합니다.

해당 액세서리에 대한 자세한 정보는 판매 대리점으로 문의하십시오.

## 환경 보호



분리 수거. 이 기호가 표시된 제품과 배터리를 일반 가정용 쓰레기와 함께 처리하면 안됩니다.

제품과 배터리에는 재활용되거나 재활용되고 고철 자원에 대한 수요를 줄일 수 있는 자재가 포함되어 있습니다. 전기 제품과 배터리는 지역 규정에 따라 재활용하십시오. 자세한 내용은 [www.2helpU.com](http://www.2helpU.com) 에서 찾아볼 수 있습니다.

## 충전용 배터리 팩













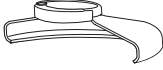
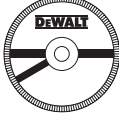

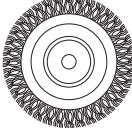

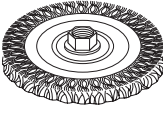
이전에 쉽게 수행했던 작업에 대해 충분한 힘을 발휘하지 못하는 배터리 팩은 재충전해야 합니다. 배터리 수명이 다하면 환경 보호 차원에서 배터리 팩을 폐기하십시오.

- 배터리 팩을 완전히 사용하고 난 후 공구에서 분리하십시오.
- 리튬이온 전지는 재활용할 수 있습니다. 이 전지를 판매점이나 지역 재활용 센터로 가져가십시오. 수집된 배터리 팩은 재활용되거나 적절히 폐기됩니다



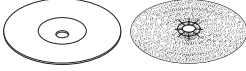



## 정비 및 수리

DeWALT 는 고객들에게 가장 효율적이고 신뢰할 수 있는 서비스를 제공하기 위하여 훈련된 직원들로 센터를 구성하고 있습니다. 사용자의 안전 및 제품의 신뢰성을 보장하기 위하여 제품의 정비, 유지 보수 및 수리는 반드시 공인된 서비스센터에서 수행해야 합니다. 자격이 없는 곳으로부터 받은 제품의 정비 및 수리는 사용자의 부상 위험 및 불이익을 초래할 수 있습니다. 가까운 DeWALT 서비스센터의 위치를 알아보려면, 제품과 함께 동봉된 전단을 통해 전화번호, 홈페이지 주소 및 기타 연락처 등을 확인할 수 있습니다.

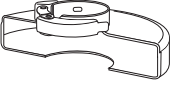
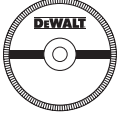
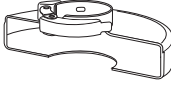
액세서리 차트

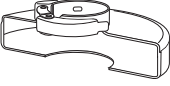
| 가드 유형   | 부속물   | 기술                          | 그라인더를 장착하는 방법  |
|---|---|-----------------------------|--|
|  <p>유형 27가드</p> |    | <p>눌린 센터<br/>그라인딩 디스크</p>   |  <p>유형 27가드</p>   |
|   |    | <p>플랩 휠</p>                 |  <p>백업 플랜지</p>   |
|   |    | <p>와이어 휠</p>                | <p>유형 27 눌린 센터 휠</p>  <p>잠금 플랜지</p>   |
|   |    | <p>나사산 너트가<br/>있는 와이어 휠</p> |  <p>유형 27가드</p>  <p>와이어 휠</p>  |
|   |    | <p>나사 너트가<br/>있는 와이어 컵</p>  |  <p>유형 27가드</p>  <p>와이어 브러쉬</p>   |
|   |  | <p>백킹 패드/<br/>샌딩 시트</p>     |  <p>유형 27가드</p>  <p>고무 백업 패드</p>  <p>샌딩 디스크</p>  <p>클램프 너트</p> |

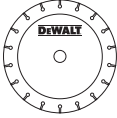
액세서리 차트 (계속)

| 가드 유형   | 부속물   | 기술            | 그라인더를 장착하는 방법   |
|---|---|---------------|---|
| <br>유형 1가드  | <br>벽돌 디스크, 접착 | 벽돌 디스크,<br>접착 | <br>유형 1가드   |
|   | <br>금속 디스크, 접착 | 금속 디스크,<br>접착 | <br>백업 플랜지   |
| <br>유형 1가드 또는<br><br>유형 27 가드 | <br>다이아몬드 휠    | 다이아몬드 휠       | <br>휠<br><br>잠금 플랜지 |

# เครื่องเจียรสวิตซ์เลื่อน DCG409

## ขอแสดงความยินดี!

คุณได้เลือกใช้เครื่องมือของ DEWALT ด้วยประสบการณ์ที่ยาวนาน ตลอดจนการพัฒนาผลิตภัณฑ์และนวัตกรรมใหม่ ๆ ทำให้ DEWALT เป็นหนึ่งในเครื่องมือไฟฟ้าที่น่าเชื่อถือที่สุดสำหรับกลุ่มผู้ใช้เครื่องมือไฟฟ้าระดับมืออาชีพ

## ข้อมูลด้านเทคนิค

|                              |                   | DCG409-TW  | DCG409-B1  | DCG409-KR  |
|------------------------------|-------------------|------------|------------|------------|
| แรงดันไฟฟ้า                  | V <sub>DC</sub>   | 18(20 Max) | 18(20 Max) | 18(20 Max) |
| ประเภทของแบตเตอรี่           |                   | Li-Ion     | Li-Ion     | Li-Ion     |
| กำลังไฟขาออกสูงสุด           | W                 | 1647       | 1647       | 1647       |
| พิกัดความเร็ว                | min <sup>-1</sup> | 9000       | 9000       | 9000       |
| เส้นผ่านศูนย์กลางของหินเจียร | mm                | 125        | 100        | 125        |
| ความหนาของหินเจียร (สูงสุด)  | mm                | 6          | 4          | 6          |
| เส้นผ่านศูนย์กลางของแกนหมุน  |                   | M14        | M10        | M10        |
| ความยาวของแกนหมุน            | mm                | 21.5       | 16         | 16         |
| น้ำหนัก (ไม่มีชุดแบตเตอรี่)  | kg                | 1.81       | 1.62       | 1.73       |

ระดับการสั่นสะเทือนและ/หรือการปล่อยเสียงตามที่ระบุไว้ในแผ่นข้อมูลนี้ได้รับการวัดตามการทดสอบมาตรฐานซึ่งระบุไว้ในมาตรฐาน EN60745 และสามารถนำมาใช้ในการเปรียบเทียบเครื่องมือหนึ่งกับเครื่องมืออื่นได้ ระดับดัง

กล่าวสามารถนำมาใช้ในการประเมินผลการสัมผัสเบื้องต้นได้เช่นกัน



**คำเตือน:** ระดับของการปล่อยแรงสั่นสะเทือนที่ระบุไว้ แสดงถึงการใช้งานหลักๆ ของเครื่องมือ อย่างไรก็ตาม หากใช้เครื่องมือกับการใช้งานอื่นๆ ร่วมกับอุปกรณ์เสริมชนิดอื่น หรือเครื่องมืออยู่ในสภาพที่ขาดการดูแล ระดับการปล่อยแรงสั่นสะเทือนอาจแตกต่างไปจากค่าที่ระบุ เนื่องจากอาจส่งผลให้ระดับการสั่นสะเทือนเพิ่มสูงขึ้นอย่างมากตลอดระยะเวลาการทำงานโดยรวม

ควรนำระดับการสั่นสะเทือนที่เหลือนอยู่ในขณะเปิดสวิตซ์เครื่องมือ หรือเมื่อปล่อยให้เครื่องทำงานแต่ไม่ได้ใช้งานใดๆ มาใช้ในการประเมินค่าด้วย เนื่องจากอาจส่งผลให้ระดับการสั่นสะเทือนลดลงอย่างมากสำหรับระยะเวลาการทำงานโดยรวม ศึกษาเพิ่มเติมถึงมาตรการรักษาความปลอดภัย ทั้งนี้ เพื่อป้องกันผู้ปฏิบัติงานจากผลกระทบของแรงสั่นสะเทือน เช่น บำรุงรักษาเครื่องมือและอุปกรณ์เสริม ทำให้มีอายุ วางแผนการทำงานอย่างเป็นระบบ



**คำเตือน:** เพื่อลดความเสี่ยงจากการบาดเจ็บ โปรดอ่านคู่มือการใช้งานเล่มนี้

## คำจำกัดความ: ข้อแนะนำด้านความปลอดภัย

คำจำกัดความด้านล่างอธิบายถึงระดับความรุนแรงของความอันตรายที่ใช้เรียกสัญลักษณ์ต่างๆ โปรดอ่านคู่มือและใส่ให้กับสัญลักษณ์ต่างๆ เหล่านี้

| แบตเตอรี่     |                   |          |             | อุปกรณ์ชาร์จ/เวลาในการชาร์จ (นาที) |        |        |        |         |         |        |         |
|---------------|-------------------|----------|-------------|------------------------------------|--------|--------|--------|---------|---------|--------|---------|
| Cat#          | V <sub>DC</sub>   | Ah       | น้ำหนัก(kg) | DCB104                             | DCB107 | DCB112 | DCB115 | DCB117  | DCB118  | DCB132 | DCB112  |
| DCB546/DCB606 | 18/54 (20/60 Max) | 6.0/2.0  | 1.05        | 60                                 | 270    | 170    | 90     | 40      | 60      | 90     | 40      |
| DCB547/DCB609 | 18/54 (20/60 Max) | 9.0/3.0  | 1.46        | 75*                                | 420    | 270    | 135*   | 60      | 75*     | 135*   | 60      |
| DCB548/DCB612 | 18/54 (20/60 Max) | 12.0/4.0 | 1.44        | 120                                | 540    | 350    | 180    | 80      | 120     | 180    | 80      |
| DCB181        | 18 (20 Max)       | 1.5      | 0.35        | 22                                 | 70     | 45     | 22     | 22      | 22      | 22     | 22      |
| DCB182/DCB204 | 18 (20 Max)       | 4.0      | 0.61        | 60/40**                            | 185    | 120    | 60     | 60/40** | 60/40** | 60     | 60/40** |
| DCB183/DCB203 | 18 (20 Max)       | 2.0      | 0.40        | 30                                 | 90     | 60     | 30     | 30      | 30      | 30     | 30      |
| DCB184/DCB205 | 18 (20 Max)       | 5.0      | 0.62        | 75/50**                            | 240    | 150    | 75     | 75/50** | 75/50** | 75     | 75/50** |
| DCB185        | 18 (20 Max)       | 1.3      | 0.35        | 22                                 | 60     | 40     | 22     | 22      | 22      | 22     | 22      |
| DCB187        | 18 (20 Max)       | 3.0      | 0.54        | 45                                 | 140    | 90     | 45     | 45      | 45      | 45     | 45      |
| DCB189/DCB240 | 18 (20 Max)       | 4.0      | 0.54        | 60                                 | 185    | 120    | 60     | 60      | 60      | 60     | 60      |
| DCB186        | 18 (20 Max)       | 6.0      | 0.95        | 60                                 | 270    | 170    | 90     | 60      | 60      | 90     | 60      |

\*รหัสรุ่นที่ 201811475B หรือหลังจากนั้น

\*\*รหัสรุ่นที่ 201536 หรือหลังจากนั้น



**อันตราย:** หมายถึงสถานการณ์ที่ก่อให้เกิดอันตรายได้อย่างฉับพลัน ซึ่งหากไม่ระวังจะทำให้เสียชีวิตหรือได้รับบาดเจ็บสาหัสได้



**คำเตือน:** หมายถึงสถานการณ์ที่มีแนวโน้มว่าจะก่อให้เกิดอันตราย ซึ่งหากไม่ระวังสามารถทำให้เกิดอันตรายถึงชีวิตหรือบาดเจ็บสาหัสได้



**ข้อควรระวัง:** หมายถึงสถานการณ์ที่มีแนวโน้มว่าจะก่อให้เกิดอันตราย ซึ่งหากไม่ระวัง อาจทำให้ได้รับบาดเจ็บเล็กน้อยหรือปานกลาง

**ข้อสังเกต:** หมายถึงการปฏิบัติที่ไม่เกี่ยวข้องกับการบาดเจ็บซึ่งหากไม่ระวังอาจทำให้ทรัพย์สินเสียหายได้



แสดงถึงความเสี่ยงจากการถูกไฟฟ้าช็อต



แสดงถึงอันตรายจากการเกิดเพลิงไหม้

## คำเตือนเพื่อความปลอดภัยทั่วไปสำหรับการใช้เครื่องมือไฟฟ้า



**คำเตือน:** อ่านคำเตือนเพื่อความปลอดภัย คำแนะนำ ภาพประกอบ และข้อมูลจำเพาะทั้งหมดซึ่งได้รับการจัดทำมาให้พร้อมทั้งเครื่องมือไฟฟ้านี้ การไม่สามารถปฏิบัติตามคำแนะนำทั้งหมดซึ่งระบุไว้ที่ด้านล่างอาจทำให้เกิดไฟฟ้าช็อต ไฟไหม้ และ/หรือการบาดเจ็บสาหัสได้

### จัดเก็บเอกสารคำเตือนและคำแนะนำทั้งหมดไว้เพื่อการอ้างอิงในภายหลัง

คำว่า "เครื่องมือไฟฟ้า" ในคำเตือน หมายถึงเครื่องมือไฟฟ้า (แบบมีสาย) ที่ทำงานผ่านแหล่งจ่ายไฟหลัก หรือเครื่องมือไฟฟ้า (แบบไร้สาย) ที่ทำงานผ่านแบตเตอรี่

### 1) ความปลอดภัยในบริเวณที่ทำงาน

- รักษาความสะอาดและจัดให้มีแสงสว่างเพียงพอในบริเวณที่ทำงาน บริเวณที่มีดหรือมีของวางระเกะระกะอาจทำให้เกิดอุบัติเหตุได้
- ห้ามใช้เครื่องมือไฟฟ้าในบริเวณที่อาจเกิดการระเบิด เช่น ในสถานที่ที่มีของเหลว แก๊ส หรือฝุ่นละอองที่มีคุณสมบัติไวไฟ เครื่องมือไฟฟ้าจะทำให้เกิดประกายไฟที่อาจทำให้เกิดประกายไฟหรือเปลวไฟขึ้นได้
- ระวังไม่ให้เด็กเล็กและคนเดินผ่านไปมาเข้าใกล้ในขณะที่ใช้งานเครื่องมือไฟฟ้า สิ่งรบกวนอาจทำให้คุณเสียสมาธิได้

### 2) ความปลอดภัยทางไฟฟ้า

- ปลั๊กไฟของเครื่องต้องเป็นชนิดเดียวกับตัวรับ ห้ามตัดแปลงปลั๊กไม่ว่าด้วยวิธีใด ห้ามใช้ปลั๊กอะแดปเตอร์ใดๆ กับเครื่องมือไฟฟ้าที่ต่อสายดิน (ลงกราวด์) ปลั๊กที่ไม่มีกราดตัดแปลงและตัวรับชนิดเดียวกันจะช่วยลดความเสี่ยงจากการเกิดไฟฟ้าช็อต
- หลีกเลี่ยงการสัมผัสพื้นผิวที่ต่อสายดินหรือลงกราวด์ เช่น ท่อ หม้อน้ำ เตาหุงต้ม และตู้เย็น

มีความเสี่ยงเพิ่มขึ้นที่จะเกิดไฟฟ้าช็อตหากร่างกายเป็นสื่อเชื่อมต่อลงดินหรือลงกราวด์

- อย่าให้เครื่องมือไฟฟ้าถูกฝนหรืออยู่ในสภาพที่เปียกชื้น น้ำที่เข้าเครื่องมือไฟฟ้าจะเพิ่มความเสี่ยงในการเกิดไฟฟ้าช็อต
- ห้ามใช้สายไฟผิดวัตถุประสงค์ ห้ามใช้สายไฟเพื่อการหิ้ว ดึง หรือถอดปลั๊กเครื่องมือไฟฟ้าเพื่อการหิ้ว ดึง หรือถอดปลั๊กเครื่องมือไฟฟ้าเก็บสายไฟให้พ้นจากความร้อน น้ำมัน ของมีคม หรือ ชิ้นส่วนที่กำลังเคลื่อนที่ สายไฟที่ชำรุดหรือพันกันเป็นการเพิ่มความเสี่ยงจากการถูกไฟฟ้าช็อต
- เมื่อใช้เครื่องมือไฟฟ้านอกอาคาร ให้ใช้สายต่อพ่วงที่เหมาะสมสำหรับการใช้งานนอกอาคาร สายไฟที่เหมาะสมสำหรับใช้นอกอาคารจะช่วยลดความเสี่ยงต่อการเกิดไฟฟ้าช็อต
- หากไม่สามารถหลีกเลี่ยงการใช้เครื่องมือไฟฟ้าในบริเวณที่ชื้นแฉะได้ ให้ใช้อุปกรณ์ป้องกันไฟดูด (RCD) การใช้ RCD จะช่วยลดความเสี่ยงในการถูกไฟฟ้าช็อต

### 3) ความปลอดภัยส่วนบุคคล

- ตื่นตัวและมีสมาธิกับสิ่งที่คุณกำลังทำ รวมทั้งใช้สามัญสำนึก ในขณะที่กำลังใช้งานเครื่องมือไฟฟ้า ห้ามใช้เครื่องมือไฟฟ้าในขณะที่คุณกำลังเหนื่อยหรือได้รับอิทธิพลจากยา แอลกอฮอล์ หรือการรักษายาบางอย่าง การขาดความระมัดระวังในการใช้เครื่องมือไฟฟ้าแม้ชั่วขณะหนึ่งอาจทำให้บาดเจ็บสาหัสได้
- ใช้อุปกรณ์คุ้มครองความปลอดภัยส่วนบุคคลสวมอุปกรณ์ป้องกันดวงตาเสมอ อุปกรณ์ป้องกันเช่น หน้ากากกันฝุ่น รองเท้านิรภัยกันลื่น หมวกนิรภัย หรืออุปกรณ์ป้องกันเสียงดังที่ใช้ในสภาวะที่เหมาะสมจะช่วยลดอาการบาดเจ็บทางร่างกาย
- ป้องกันเครื่องเปิดทำงานโดยไม่ตั้งใจ สวิตช์ต้องอยู่ในตำแหน่งปิดก่อนที่จะเสียบปลั๊กเข้ากับแหล่งจ่ายไฟ และ/หรือ ขดแบบเตอร์ หรือก่อนจะยกหรือหัวเครื่องมือ การยกเครื่องมือไฟฟ้าในขณะที่นิ้วอยู่ที่สวิตช์ หรือใช้เครื่องมือไฟฟ้าที่สวิตช์เปิดอยู่ อาจทำให้เกิดอุบัติเหตุได้
- ถอดกุญแจปรับตั้งหรือประแจออกก่อนเปิดสวิตช์เครื่องมือไฟฟ้า ประแจหรือกุญแจที่เสียบค้างอยู่ในชิ้นส่วนที่หมุนได้ของเครื่องมือไฟฟ้าอาจทำให้ได้รับบาดเจ็บได้
- ห้ามยืนเขย่งเท้าขณะใช้เครื่อง ควรยืนในท่าที่เหมาะสมและสมดุลตลอดเวลา เพื่อช่วยในการควบคุมเครื่องมือไฟฟ้าได้ดียิ่งขึ้นในสถานการณ์ที่ไม่คาดคิด
- แต่ก่อนให้เหมาะสม ห้ามสวมเสื้อผ้าหลวมหรือใส่เครื่องประดับ รวบผมและเสื้อผ้าให้ห่างจากชิ้นส่วนที่กำลังหมุน เสื้อผ้าที่หลวมหรือยารวมรั่ว เครื่องประดับ หรือผมที่ยาวอาจเข้าไปพันกับชิ้นส่วนที่กำลังหมุน

- g) หากมีอุปกรณ์สำหรับดูดและเก็บฝุ่น ต้องตรวจสอบให้แน่ใจว่าได้เชื่อมต่อและใช้งานอุปกรณ์นั้นอย่างเหมาะสม การใช้อุปกรณ์เก็บฝุ่นจะช่วยลดอันตรายที่เกี่ยวข้องกับฝุ่นได้
- h) อย่าวัดความเค้นขืนจากการใช้งานทำให้คุณประมาทและละเลยการปฏิบัติตามหลักการเพื่อความปลอดภัย การใช้งานโดยไม่ระวังอาจทำให้เกิดการบาดเจ็บสาหัสได้ภายในเวลาเพียงเสี้ยววินาที

#### 4) การใช้งานและการดูแลรักษาเครื่องมือไฟฟ้า

- a) ห้ามฝืนใช้เครื่องมือไฟฟ้า เลือกใช้เครื่องมือไฟฟ้าที่ถูกต้องตรงกับลักษณะการใช้งานของคุณ เครื่องมือไฟฟ้าที่ถูกต้องย่อมทำงานได้ดีกว่าและปลอดภัยกว่า เมื่อใช้งานตามที่คิดที่เครื่องมือได้รับการออกแบบมา
- b) ห้ามใช้เครื่องมือไฟฟ้าถ้าสวิทช์เปิดปิดเครื่องไม่ทำงาน เครื่องมือไฟฟ้าที่ไม่สามารถควบคุมผ่านสวิทช์ได้ ถือว่ามีอันตรายและต้องส่งซ่อม
- c) ถอดปลั๊กของเครื่องมือไฟฟ้าออกจากแหล่งจ่ายไฟ และ/หรือหากถอดแบตเตอรี่ได้ ให้ถอดแบตเตอรี่ออกก่อนทำการปรับแต่ง เปลี่ยนอุปกรณ์เสริม หรือจัดเก็บเครื่องมือไฟฟ้า มาตรการเพื่อความปลอดภัยเชิงการป้องกันจะช่วยลดความเสี่ยงในการเผลอเปิดเครื่องไฟฟ้าให้ทำงานโดยไม่ตั้งใจ
- d) เก็บเครื่องมือไฟฟ้าที่ไม่ได้ใช้งานไว้ในพื้นที่แห้ง และไมอนุญาตให้บุคคลที่ไม่คุ้นเคยกับเครื่องมือไฟฟ้าหรือคำแนะนำเหล่านี้เป็นผู้ใช้เครื่องมือ เครื่องมือไฟฟ้าจะเป็นอันตรายหากอยู่ในมือผู้ใช้ที่ไม่มีประสบการณ์
- e) บำรุงรักษาเครื่องมือไฟฟ้าและอุปกรณ์เสริมต่างๆ ตรวจสอบว่าชิ้นส่วนที่เคลื่อนที่ได้มีการวางไม่ตรงแนวหรือติดขัดหรือไม่ มีชิ้นส่วนที่แตกหัก และสภาพอื่นใดที่อาจส่งผลกระทบต่อการทำงานของเครื่องมือไฟฟ้าหรือไม่ หากชำรุดเสียหาย ให้นำเครื่องมือไปส่งซ่อมก่อนนำมาใช้ อุบัติเหตุจำนวนมากเกิดจากการดูแลรักษาเครื่องมือไฟฟ้าไม่ดีพอ
- f) เครื่องมือตัดต้องคมและสะอาดอยู่เสมอ เครื่องมือตัดที่ได้รับการดูแลรักษาอย่างถูกต้องและมีขอบตัดคม จะมีปัญหาติดขัดน้อย และควบคุมได้ง่ายกว่า
- g) ใช้เครื่องมือไฟฟ้า อุปกรณ์เสริม และดอกสว่านของเครื่องมือ เป็นต้น ให้ตรงตามข้อปฏิบัติเหล่านี้ โดยพิจารณาถึงสภาพการทำงานและงานที่ทำเป็นสำคัญ การใช้เครื่องมือไฟฟ้าทำงานอื่นนอกเหนือจากที่กำหนดไว้อาจทำให้เกิดอันตรายได้
- h) หมั่นดูแลให้มือจับและพื้นผิวที่จับนั้นแห้ง สะอาด ปราศจากน้ำมันและจาระบี มือจับและผิวสัมผัสที่ลื่นอาจทำให้เกิดการใช้งานที่ไม่ปลอดภัย

และทำให้ไม่สามารถควบคุมเครื่องมือในสถานการณ์คับขันได้อย่างถูกต้อง

#### 5) การใช้และการดูแลรักษาแบตเตอรี่

- a) ชาร์จแบตเตอรี่ด้วยเครื่องชาร์จที่ผู้ผลิตแนะนำเท่านั้น เครื่องชาร์จที่เหมาะสมกับแบตเตอรี่แบบหนึ่งอาจทำให้เกิดไฟไหม้ได้ถ้านำมาใช้กับแบตเตอรี่อีกแบบหนึ่ง
- b) ใช้เครื่องมือไฟฟ้าเฉพาะกับก้อนแบตเตอรี่ที่ออกแบบมาเป็นพิเศษเท่านั้น การใช้แบตเตอรี่แบบอื่นอาจทำให้เกิดการบาดเจ็บหรือเกิดไฟไหม้ได้
- c) เมื่อไม่ได้ใช้ก้อนแบตเตอรี่ ให้เก็บออกห่างจากวัตถุอื่นๆ ที่เป็นโลหะ เช่น คลิปหนีบกระดาษ เหรียญ กุญแจ เข็ม สกรูหรือวัตถุขนาดเล็กอื่นๆ ที่ทำจากโลหะที่อาจทำให้เกิดการเชื่อมต้อจากขั้วหนึ่งไปอีกขั้วหนึ่ง การลัดวงจรบริเวณขั้วแบตเตอรี่อาจทำให้เกิดรอยไหม้หรือไฟไหม้ได้
- d) เมื่ออยู่ภายใต้สภาวะที่ไม่เหมาะสม อาจมีของเหลวไหลออกมาจากแบตเตอรี่ ให้หลีกเลี่ยงการสัมผัสกับของเหลวนี้ หากมีสิ่งสัมผัสโดยไม่ตั้งใจ ให้ล้างออกด้วยน้ำปริมาณมาก หากของเหลวกระเด็นเข้าตา ควรรีบไปพบแพทย์ของเหลวที่ออกมาจากแบตเตอรี่อาจทำให้เกิดอาการระคายเคืองหรือรอยไหม้ได้
- e) ห้ามใช้แบตเตอรี่หรือเครื่องมือที่มีการชำรุดเสียหายหรือได้รับการตัดแปลง แบตเตอรี่ที่ชำรุดเสียหายหรือได้รับการตัดแปลงอาจทำให้เกิดเหตุการณ์ที่ไม่คาดคิด เช่น ไฟไหม้ ระเบิด หรือความเสี่ยงอันก่อให้เกิดการบาดเจ็บได้
- f) อย่าวางแบตเตอรี่หรือเครื่องมือถูกไฟไหม้หรืออยู่ในที่ที่มีอุณหภูมิสูงเกินไป หากแบตเตอรี่ถูกไฟไหม้หรืออยู่ในที่ที่มีอุณหภูมิสูงเกิน 130 °C อาจทำให้เกิดการระเบิดได้
- g) ปฏิบัติตามคำแนะนำการชาร์จทุกขั้นตอนและไม่ชาร์จแบตเตอรี่หรือเครื่องมือในอุณหภูมิที่เกินจากที่กำหนดไว้ในคำแนะนำ การชาร์จที่ไม่ถูกต้องหรือในอุณหภูมิที่นอกเหนือจากที่กำหนดไว้ อาจทำให้แบตเตอรี่เสียหายและเสี่ยงต่อการเกิดไฟไหม้ได้

#### 6) การบริการ

- a) ให้ช่างซ่อมที่มีความเชี่ยวชาญเป็นผู้ซ่อมเครื่องมือไฟฟ้า และใช้อะไหล่ของแท้เท่านั้น ซึ่งจะช่วยให้คุณมั่นใจได้ว่าเครื่องมือไฟฟ้ายังมีความปลอดภัยอยู่
- b) ห้ามซ่อมแบตเตอรี่ที่ชำรุด ควรให้ผู้ผลิตหรือผู้ให้บริการที่ผ่านการรับรองเป็นผู้ซ่อมแบตเตอรี่เท่านั้น

## กฎความปลอดภัยโดยเฉพาะเพิ่มเติม คำแนะนำความปลอดภัยสำหรับการ ใช้งานทั้งหมด

- a) เครื่องมือไฟฟ้านี้มีเจตนาเพื่อการใช้งานเป็นเครื่องเจียร แปลงลวด หรือเครื่องมือตัด อ่านคำเตือนเกี่ยวกับความปลอดภัย คำแนะนำ ภาพประกอบและรายละเอียดทั้งหมดซึ่งระบุไว้สำหรับเครื่องมือไฟฟ้านี้ การไม่ปฏิบัติตามคำแนะนำทั้งหมดซึ่งระบุไว้ที่ด้านล่างอาจส่งผลให้เกิดไฟฟ้าดูด ไฟไหม้ และ/หรือการบาดเจ็บส่วนบุคคลได้
- b) ไม่แนะนำให้คนทำงานต่างๆ อย่างการขัดด้วยกระดาษทรายหรือการขัดโดยใช้เครื่องมือไฟฟ้านี้ การใช้งานเครื่องมือไฟฟ้าซึ่งไม่ได้มีการระบุเอาไว้ว่าอาจก่อให้เกิดอันตรายและการบาดเจ็บส่วนบุคคลได้
- c) ห้ามใช้อุปกรณ์เสริมซึ่งไม่ได้รับการออกแบบและแนะนำโดยเฉพาะโดยผู้ผลิตเครื่องมือ การที่คุณสามารถใส่อุปกรณ์เสริมเข้ากับเครื่องมือไฟฟ้าของคุณได้ไม่ได้รับประกันถึงการทำงานที่ปลอดภัย
- d) ความเร็วที่กำหนดของอุปกรณ์เสริมจะต้องเท่ากับความเร็วสูงสุดซึ่งระบุไว้บนเครื่องมือไฟฟ้าเป็นอย่างน้อย อุปกรณ์เสริมที่ทำงานเร็วกว่าความเร็วที่กำหนดอาจแตกหักและระเบิดได้
- e) เส้นผ่านศูนย์กลางภายนอกและความหนาของอุปกรณ์เสริมของคุณจะต้องอยู่ในอัตราความสามารถของเครื่องมือไฟฟ้าของคุณ อุปกรณ์เสริมที่มีขนาดไม่ถูกต้องจะไม่สามารถได้รับการปกป้องหรือการควบคุมอย่างเพียงพอได้
- f) การติดตั้งแบบเกลียวของอุปกรณ์เสริมจะต้องเข้าที่กับเกลียวแกนหมุนของเครื่องเจียร สำหรับอุปกรณ์เสริมที่มีการติดตั้งหน้าแปลน รูอาร์เบอร์ของอุปกรณ์เสริมจะต้องพอดีกับเส้นผ่านศูนย์กลางของหน้าแปลน อุปกรณ์เสริมที่ไม่เข้าที่กับเครื่องมือสำหรับการติดตั้งของเครื่องมือไฟฟ้าจะทำให้ความสมดุลหมดไป สั่นสะเทือนอย่างรุนแรง และก่อให้เกิดการสูญเสียการควบคุมได้
- g) ห้ามใช้อุปกรณ์เสริมที่ชำรุดเสียหาย ก่อนการใช้งานในแต่ละครั้ง คุณจะต้องตรวจสอบอุปกรณ์เสริมก่อน เช่น ตรวจสอบลวดขัดเงาเพื่อหารอยแหวนและรอยแตก ตรวจสอบแผ่นรองเพื่อหารอยแตก การฉีกขาดและการสึกหรอส่วนเกิน และตรวจสอบแปรงลวดเพื่อดูว่าลวดหลวมหรือแตกหรือไม่ หากคุณทำเครื่องมือไฟฟ้าหรืออุปกรณ์เสริมตก คุณจะต้องตรวจสอบความเสียหายหรือติดตั้งอุปกรณ์เสริมที่ไม่ชำรุดเสียหาย หลังจากตรวจสอบและติดตั้งอุปกรณ์เสริมแล้ว คุณและผู้ที่ยืนดูอยู่จะต้องอยู่ในที่ไกลจากอุปกรณ์เสริมที่กำลังหมุน และใช้งานเครื่องมือไฟฟ้าที่ความเร็วสูงสุดแบบไม่มีกระแสไหลดเป็น

เวลาหนึ่งนาที อุปกรณ์เสริมที่ชำรุดเสียหายมักจะแตกหักออกจากกันระหว่างการทดสอบนี้

- h) สวมอุปกรณ์ป้องกันส่วนบุคคล ใช้กระบังป้องกันใบหน้า แวนตาปริบ์หรือกระจกนิรภัยตามแต่การใช้งานของคุณ คุณจะต้องสวมหมวกกันน็อก อุปกรณ์ป้องกันการได้ยิน ถุงมือและผ้ากันเปื้อนที่สามารถหยุดยั้งเศษจากการขัดและเศษจากชิ้นงานตามความเหมาะสม การปกป้องดวงตาจะต้องสามารถหยุดยั้งเศษที่ลอยไปมาซึ่งเกิดจากการทำงานต่างๆ ได้ หมวกกันน็อกหรืออุปกรณ์ป้องกันระบบหายใจจะต้องสามารถกรองอนุภาคซึ่งเกิดจากการทำงานของคุณได้ การได้ยินเสียงดังความเข้มสูงเป็นเวลานานอาจทำให้สูญเสียการได้ยินได้
- i) กันผู้ที่ยืนดูให้อยู่ห่างออกไปจากบริเวณที่มีการปฏิบัติงาน ผู้ใดก็ตามที่เข้ามาในบริเวณที่มีการปฏิบัติงานจะต้องสวมอุปกรณ์ป้องกันส่วนบุคคล เศษของชิ้นงานหรืออุปกรณ์ที่แตกหักอาจลอยไปทางอื่น และก่อให้เกิดการบาดเจ็บนอกบริเวณที่มีการปฏิบัติงานได้
- j) ถัดเครื่องมือไฟฟ้าโดยการจับผิวหนังที่กันฉนวน เมื่อต้องปฏิบัติงานที่อุปกรณ์เสริมสำหรับการตัด อาจสัมผัสอุปกรณ์เดินสายไฟที่ซ่อนอยู่ อุปกรณ์เสริมสำหรับการตัดหรืออุปกรณ์จับยึดที่สัมผัสลูกสายไฟที่มี "ไฟฟ้า" อยู่อาจทำให้ชิ้นส่วนโลหะของเครื่องมือไฟฟ้า "มีไฟฟ้า" และทำให้ผู้ปฏิบัติงานถูกไฟฟ้าดูดได้
- k) ห้ามวางเครื่องมือไฟฟ้าลงจนกว่าอุปกรณ์เสริมจะหยุดสนิท อุปกรณ์เสริมที่กำลังหมุนอาจจับไปที่ผิวหนังและดึงเครื่องมือไฟฟ้าออกจากการควบคุมของคุณได้
- l) ห้ามใช้งานเครื่องมือไฟฟ้าในขณะที่ถือเครื่องมือไฟฟ้าในมือของคุณ การสัมผัสอุปกรณ์เสริมที่กำลังหมุนโดยไม่เจตนาอาจกระชากเสื้อผ้าของคุณหรือดึงอุปกรณ์เสริมไปหาตัวคุณได้
- m) ทำความสะอาดช่องระบายอากาศเป็นประจำ พัฒลมของมอเตอร์จะดึงฝุ่นเข้ามาที่ด้านในของตัวเรือนในขณะที่การสะสมฝุ่นโลหะที่มากเกินไปจะทำให้เกิดอันตรายจากไฟฟ้าได้
- n) ห้ามใช้งานเครื่องมือไฟฟ้าใกล้กับวัสดุไวไฟ ประกายไฟสามารถทำให้วัสดุดังกล่าวติดไฟได้
- o) ห้ามใช้อุปกรณ์เสริมที่ต้องใช้สารหล่อเย็นที่เป็นของเหลว การใช้น้ำหรือสารหล่อเย็นที่เป็นของเหลวอื่นๆ อาจทำให้เกิดการเสียชีวิตด้วยกระแสไฟฟ้าหรือไฟฟ้าดูดได้
- p) ห้ามใช้หินเจียรประเภท 11 (หินครก) กับเครื่องมือนี้ การใช้อุปกรณ์เสริมที่ไม่เหมาะสมจะทำให้เกิดการบาดเจ็บได้
- q) ใช้ด้ามจับด้านข้างอยู่เสมอ ชันด้ามจับให้แน่น คุณจะต้องใช้ด้ามจับด้านข้างอยู่เสมอเพื่อคงไว้ซึ่งการควบคุมเครื่องมือตลอดเวลา





**คำเตือน:** เราแนะนำให้คุณใช้เครื่องตัดไฟรั่วซึ่งมีฟังก์ชันกระแสไฟเหลือที่ 30mA หรือต่ำกว่า

## คำแนะนำความปลอดภัยเพิ่มเติม สำหรับการใช้งานทั้งหมด

### สาเหตุและการป้องกันผู้ปฏิบัติงาน จากการสะท้อนกลับ

การสะท้อนกลับเป็นปฏิกิริยาแบบฉับพลันที่มีต่อการหนีบหรือการตัดค้างของล่อหมุน แผ่นรอง แปรงหรืออุปกรณ์เสริมอื่นๆ การหนีบหรือการกระชากจะก่อให้เกิดการหยุดทำงานกลางคันอย่างรวดเร็วซึ่งในทางกลับกันจะทำให้เครื่องมือไฟฟ้าที่ไม่สามารถควบคุมได้ถูกบังคับไปในทิศทางตรงข้ามกับการหมุนของอุปกรณ์ตรงจุดที่มีการตัดค้าง

ตัวอย่างเช่น หากล่อขัดเงาถูกกระชากหรือถูกหนีบโดยขึ้นงาน ขอบของล่อซึ่งเข้าไปในจุดที่มีการหนีบอาจหลุดเข้าไปในผิวหน้าของวัสดุจนทำให้ล่อหลุดออกมาหรือสะท้อนกลับได้ ล้ออาจจะกระเด็นเข้าหาหรือกระเด็นห่างออกไปจากผู้ปฏิบัติงานได้ขึ้นอยู่กับทิศทางเคลื่อนไหวของล่อตรงจุดที่มีการหนีบ ล่อขัดเงาอาจจะแตกหักได้ภายใต้สภาพดังต่อไปนี้

การสะท้อนกลับเป็นผลมาจากการใช้งานเครื่องมือไฟฟ้าไม่ถูกต้อง และ/หรือขั้นตอนหรือสภาพการทำงานที่ไม่ถูกต้องซึ่งเป็นเรื่องที่สามารถหลีกเลี่ยงได้โดยการปฏิบัติตามข้อควรระวังตามที่ระบุข้างล่างอย่างเหมาะสม

- ดงไว้ซึ่งการจับบนเครื่องมือไฟฟ้าอย่างแน่นหนา และวางตำแหน่งร่างกายและแขนของคุณเพื่อให้คุณสามารถต้านทานแรงสะท้อนกลับได้** หากมีการจัดหามาให้พร้อมกับเครื่องมือ ให้คุณใช้ด้ามจับเสริมในการควบคุมการสะท้อนกลับสูงสุดหรือปฏิกิริยาจากแรงบิดในระหว่างการเริ่มต้นอยู่เสมอ ผู้ปฏิบัติงานสามารถควบคุมปฏิกิริยาจากแรงบิดหรือแรงสะท้อนกลับได้หากมีการปฏิบัติตามข้อควรระวังอย่างเหมาะสม
- ห้ามวางมือของคุณไว้ใกล้กับอุปกรณ์เสริมที่กำลังหมุนโดยเด็ดขาด** อุปกรณ์เสริมอาจจะสะท้อนกลับเหนื่อมือของคุณได้
- ห้ามวางตำแหน่งร่างกายของคุณไว้ในบริเวณที่เครื่องมือไฟฟ้าจะเคลื่อนไหวหากเกิดการสะท้อนกลับขึ้น** การสะท้อนกลับจะบังคับเครื่องมือไปในทิศทางตรงข้ามกับการเคลื่อนไหวของล่อตรงจุดที่มีการกระชาก
- ใช้การดูแลเป็นพิเศษเมื่อต้องทำงานกับมุมขอบคม ฯลฯ หลีกเลี่ยงการกระเด็นและการกระชากอุปกรณ์เสริม** มุม ขอบคมหรือการกระเด็นมีแนวโน้มที่จะกระชากอุปกรณ์เสริมที่กำลังหมุน และก่อให้เกิดการสูญเสียการควบคุมหรือเกิดการสะท้อนกลับได้
- ห้ามใส่ใบเลื่อยโซ่ตัดไม้หรือใบเลื่อยที่มีฟัน ใบเลื่อยดังกล่าวจะทำให้เกิดการสะท้อนกลับและการสูญเสียการควบคุมบ่อยครั้ง**

## คำเตือนเพื่อความปลอดภัยโดยเฉพาะ สำหรับการเจียรและการตัดแบบกั๊ดกรอน

- ใช้เฉพาะประเภทของใบตัดที่แนะนำสำหรับเครื่องมือไฟฟ้าของคุณรวมถึงอุปกรณ์ป้องกันเฉพาะซึ่งได้รับการออกแบบมาสำหรับใบตัดที่เลือกเท่านั้น** ใบตัดซึ่งไม่ได้รับการออกแบบมาสำหรับเครื่องมือไฟฟ้าจะไม่สามารถได้รับการป้องกันอย่างเพียงพอและไม่ปลอดภัย
- ผิวหน้าการเจียรของใบตัดที่ตกลงตรงกลางจะต้องได้รับการติดตั้งไว้ที่ด้านล่างของระบบของขอบป้องกัน** ใบตัดซึ่งได้รับการติดตั้งอย่างไม่เหมาะสมที่ยื่นออกมาผ่านระบบของขอบป้องกันจะไม่สามารถได้รับการป้องกันอย่างเพียงพอได้
- อุปกรณ์ป้องกันจะต้องได้รับการติดเข้ากับเครื่องมือไฟฟ้าอย่างแน่นหนาและอยู่ในตำแหน่งที่มีความปลอดภัยสูงสุดเพื่อที่ปริมาณของใบตัดที่น้อยที่สุดจะตรงไปหาผู้ปฏิบัติงาน** อุปกรณ์ป้องกันจะช่วยป้องกันผู้ปฏิบัติงานจากเศษใบตัดที่แตกหัก การสัมผัสใบตัดโดยไม่เจนา และประกายไฟที่อาจทำให้เสื้อผ้าติดไฟได้
- ใบตัดจะต้องได้รับการใช้งานตามการใช้งานที่แนะนำเท่านั้น** ตัวอย่างเช่น: ห้ามทำการเจียรโดยใช้ด้านข้างของใบตัด ใบตัดแบบซัดมีเจนาเพื่อการเจียรรอบนอก แรงต้านข้างที่ใช้กับใบตัดดังกล่าวอาจทำให้ใบตัดแตกเป็นเสี่ยงได้
- ใช้หน้าแปลนของใบตัดที่ไม่ชำรุดเสียหายซึ่งมีขนาดและรูปทรงที่ถูกต้องสำหรับใบตัดที่เลือกของคุณอยู่เสมอ** หน้าแปลนของใบตัดที่เหมาะสมจะรองรับใบตัด เมื่อเป็นเช่นนี้จึงช่วยลดความเป็นไปได้ในการแตกหักของใบตัด หน้าแปลนสำหรับใบตัดอาจแตกต่างกันไปจากหน้าแปลนของหินเจียร
- ห้ามใช้ใบตัดที่เสื่อมสภาพจากเครื่องมือไฟฟ้าที่มีขนาดใหญ่กว่า** ใบตัดสำหรับเครื่องมือไฟฟ้าที่มีขนาดใหญ่กว่าไม่เหมาะสมกับความเร็วที่สูงขึ้นของเครื่องมือที่ขนาดเล็กกว่า และอาจเกิดการระเบิดได้

## คำเตือนเพื่อความปลอดภัยเพิ่มเติมโดย เฉพาะสำหรับการตัดแบบกั๊ดกรอน

- ห้าม "ดัน" ใบเจียร หรือใช้แรงกดที่มากเกินไป** ห้ามพยายามทำการตัดจนมีความลึกที่มากเกินไป ทั้งนี้ การใช้ความดันที่มากเกินไปกับใบเจียรจะเพิ่มการไหล และทำให้เกิดการบิดงอหรือการทำให้ใบเจียรพันเข้าไปในการตัด รวมถึงอาจทำให้เกิดการสะท้อนกลับ หรือทำให้ใบเจียรแตกหักได้
- ห้ามวางตำแหน่งร่างกายของคุณให้อยู่ในแนวเดียวกันและอยู่ที่ด้านหลังของใบเจียรที่กำลังหมุน** ในขณะที่กำลังปฏิบัติงาน เมื่อใบเจียรขยับห่างจากร่างกายของคุณ การสะท้อนกลับที่อาจเกิดขึ้นอาจขับเคลื่อนใบเจียรที่กำลังหมุนและเครื่องมือไฟฟ้าให้มาทางคุณได้

- c) **มือใบเจียร์เกิดการพันหรือเมื่อการตัดหยุดชะงัก** ไม่ว่าจะด้วยเหตุผลใดก็ตาม คุณจะต้องปิดเครื่องมือ และหยุดการเคลื่อนไหวของเครื่องมือไฟฟ้าจนกระทั่งใบเจียร์หยุดสนิท ห้ามพยายามย่นนำใบเจียร์ออกจากการตัดในขณะที่ใบเจียร์กำลังเคลื่อนไหวโดยเด็ดขาด มิเช่นนั้นอาจทำให้เกิดการสะท้อนกลับได้ ตรวจสอบและดำเนินการแก้ไขเพื่อกำจัดสาเหตุของการพันของใบเจียร์
- d) ห้ามเริ่มการตัดในชิ้นงานอีกครั้ง ปล่อยให้ใบเจียร์ขึ้นถึงความเร็วเต็มอัตรา และเข้าสู่การตัดอย่างระมัดระวัง ใบเจียร์อาจเกิดการพัน ชยับ ออกจากตำแหน่ง หรือสะท้อนกลับได้หากเครื่องมือไฟฟ้าในชิ้นงานถูกรีสตาร์ท
- e) **คำย่นแผงหรือชิ้นงานที่มีขนาดใหญ่เกินไปเพื่อลดความเสี่ยงในการหนีบและการสะท้อนกลับของใบเจียร์** ทั้งนี้ ชิ้นงานที่มีขนาดใหญ่มีแนวโน้มที่จะตกลงมาได้เนื่องจากน้ำหนักของชิ้นงานเอง คุณจะต้องวางที่คำย่นไว้ที่ด้านล่างของชิ้นงานใกล้กับแนวตัด และใกล้กับขอบของชิ้นงานบนทั้งสองด้านของใบเจียร์
- f) **ใช้ความระมัดระวังเป็นพิเศษเมื่อทำการ "ตัด" เข้าไปในผนังหรือจุดบอดอื่นๆ ที่มีอยู่** ใบเจียร์ที่ยื่นออกมาอาจตัดโดนท่อก๊าซหรือท่อน้ำ สายไฟ หรือวัตถุต่างๆ ที่สามารถทำให้เกิดการสะท้อนกลับได้

**คำเตือนเพื่อความปลอดภัยโดยเฉพาะสำหรับการชดทรา**

- a) ห้ามใช้กระดาดชทราที่มีขนาดใหญ่มากเกินไป ปฏิบัติตามคำแนะนำของผู้ผลิตเมื่อทำการเลือกกระดาดชทรา กระดาดชทราที่มีขนาดใหญ่ซึ่งอยู่เกินออกมาจากแผ่นชดทราจะทำให้เกิดอันตรายจากการฉีกขาด และทำให้เกิดการขีดข่วน การขาดหรือการสะท้อนกลับของใบเจียร์ได้

**คำเตือนเพื่อความปลอดภัยโดยเฉพาะสำหรับการแปรงลวด**

- a) **พึงทราบว่า ขนของแปรงลวดอาจถูกปล่อยออกมาจากแปรงได้แม้แต่ในระหว่างการทำงานตามปกติ** ห้ามใช้แรงเค้นกับลวดมากเกินไปโดยการใส่โซ่ที่มากเกินไปกับแปรง ขนของแปรงลวดอาจเข้าไปเสียดผ้าที่บางเบาและ/หรือผิวหนังได้
- b) **หากมีการแนะนำให้ใช้อุปกรณ์ป้องกันสำหรับการแปรงลวด** คุณจะต้องไม่ปล่อยให้อุปกรณ์ป้องกันถูกรบกวนจากแปรงลวดกลมหรือแปรงลวด ทั้งนี้ ขนาดเส้นผ่านศูนย์กลางของแปรงลวดกลมหรือแปรงลวดอาจเพิ่มขึ้นเนื่องจากการทำงานและแรงเหวี่ยงได้

**ความเสี่ยงอื่น ๆ ที่ยังมีอยู่**

แม้จะปฏิบัติตามข้อกำหนดด้านความปลอดภัยที่เกี่ยวข้องและใช้อุปกรณ์นิรภัยแล้วก็ตาม แต่ก็ไม่สามารถหลีกเลี่ยงความเสี่ยงบางอย่างได้ ความเสี่ยงเหล่านั้นได้แก่:

- ความบกพร่องในการได้ยินเสียง
- ความเสี่ยงที่จะได้รับบาดเจ็บจากเศษชิ้นงานที่ปลิว
- ความเสี่ยงที่จะเกิดรอยไหม้เนื่องจากอุปกรณ์เสริมที่ร้อนขึ้นในระหว่างการใช้งาน
- ความเสี่ยงที่จะได้รับบาดเจ็บเนื่องจากการใช้งานเป็นเวลานาน
- ความเสี่ยงในการเกิดฝุ่นจากสารอันตราย

**เครื่องชาร์จ**

เครื่องชาร์จ DEWALT สามารถใช้งานได้โดยไม่ต้องปรับแต่ง และได้รับการออกแบบมาเพื่อให้ใช้งานง่ายที่สุด

**ความปลอดภัยทางไฟฟ้า**

มอเตอร์ไฟฟ้าออกแบบมาเพื่อใช้กับแรงดันไฟฟ้าขนาดเดียวกันนั้น ต้องตรวจสอบแรงดันไฟฟ้าของแบตเตอรี่ให้ตรงกับแรงดันไฟฟ้าบนแผ่นแสดงที่กีดเสมอ รวมทั้งตรวจสอบว่าแรงดันไฟฟ้าของเครื่องชาร์จตรงกับกับสายไฟตู้เครื่องของคุณ



เครื่องชาร์จ DEWALT ของคุณมีฉนวนสองชั้นตามมาตรฐาน IEC60335 ดังนั้นจึงไม่จำเป็นต้องใช้สายดิน.

หากสายไฟชำรุด เฉพาะ DEWALT หรือองค์กรจัดการซ่อมบำรุงที่ได้รับอนุญาตเท่านั้นที่สามารถเปลี่ยนชิ้นส่วนดังกล่าวได้

**การใช้สายพวง**

ห้ามใช้สายต่อพวงเว้นแต่มีความจำเป็นอย่างหลีกเลี่ยงไม่ได้ ควรใช้สายต่อพวงที่ผ่านการรับรองและเหมาะสมกับกำลังไฟเข้าของเครื่องชาร์จ (**ดูข้อมูลด้านเทคนิค**) ขนาดต่ำสุดของสายไฟคือ 1 ตร.มม. ความยาวสูงสุด คือ 30 ม. เมื่อมีการใช้อุปกรณ์ม้วนเก็บสายไฟ ให้คลายสายไฟออกจนหมดทุกครั้ง

**คำแนะนำเพื่อความปลอดภัยที่สำคัญสำหรับ**

**เครื่องชาร์จแบตเตอรี่ทุกชนิด**

**เก็บรักษาคำแนะนำเหล่านี้:** คู่มือนี้ประกอบด้วยคำแนะนำด้านความปลอดภัยและการใช้งานที่สำคัญสำหรับเครื่องชาร์จแบตเตอรี่ที่ใช้ทำงานร่วมกันได้ (**ดูข้อมูลด้านเทคนิค**)

- ก่อนใช้งานเครื่องชาร์จ โปรดอ่านคำแนะนำและสัญลักษณ์เตือนทั้งหมดบนเครื่องชาร์จ แบตเตอรี่ และผลิตภัณฑ์ที่ใช้แบตเตอรี่



**คำเตือน:** อันตรายจากการถูกไฟฟ้าช็อต อย่าให้มือของคุณเข้าไปภายในเครื่องชาร์จ เพราะอาจทำให้เกิดไฟฟ้าช็อตได้



**คำเตือน:** เราแนะนำการใช้อุปกรณ์ป้องกันไฟดูดที่มีกระแสไฟไม่เกิน 30 มิลลิแอมป์



**ข้อควรระวัง:** อันตรายจากไฟไหม้ เพื่อลดความเสี่ยงของการเกิดการบาดเจ็บ โปรดใช้แบตเตอรี่แบบชาร์จซ้ำได้ของ DEWALT เท่านั้น แบตเตอรี่ชนิดอื่นๆ อาจระเบิดทำให้เกิดการบาดเจ็บและความเสียหายได้



**ข้อควรระวัง:** เด็กควรได้รับการควบคุมดูแลเพื่อให้อย่างแน่ใจว่าเด็กจะไม่เล่นเครื่องมือ

**ข้อสังเกต:** ในบางสถานการณ์ ระหว่างที่เครื่องชาร์จเสียบปลั๊กอยู่ อาจมีวัตถุแปลกปลอมเข้าไปภายในเครื่องชาร์จและทำให้ตัวชาร์จไฟลัดวงจรได้อย่าให้มีวัตถุแปลกปลอมที่มีคุณสมบัตินำไฟฟ้า เช่นฝอยเหล็ก อะลูมิเนียมฟอยล์ หรือการสะสมตัวของอนุภาคโลหะอยู่ในช่องใส่แบตเตอรี่ของเครื่องชาร์จและถอดปลั๊กเครื่องชาร์จออกเสมอ เมื่อไม่มีชุดแบตเตอรี่อยู่ในช่องใส่ รวมทั้งถอดปลั๊กเครื่องชาร์จทุกครั้งก่อนทำความสะอาด

- **อย่าชาร์จแบตเตอรี่ด้วยตัวเครื่องชาร์จเครื่องอื่นๆ** นอกเหนือจากเครื่องชาร์จที่ระบุในคู่มือเล่มนี้โดยเด็ดขาด เครื่องชาร์จและชุดแบตเตอรี่ได้รับการออกแบบมาให้ใช้งานร่วมกันโดยเฉพาะ
- **เครื่องชาร์จนี้ไม่ได้ออกแบบมาเพื่อการใช้งานใดๆ นอกจากชาร์จแบตเตอรี่แบบชาร์จซ้ำได้ของ DEWALT การนำไปใช้ในงานอื่นนอกจากนี้อาจเสี่ยงต่อการเกิดไฟไหม้ ไฟฟ้าช็อต หรืออันตรายจากไฟฟ้าจนถึงแก่ชีวิตได้**
- **อย่าให้เครื่องชาร์จถูกฝนหรือหิมะ**
- **ดึงปลั๊กเครื่องชาร์จที่หัวปลั๊กแทนการดึงที่สายไฟ** เมื่อจะถอดปลั๊กเครื่องชาร์จ วิธีนี้จะช่วยลดความเสี่ยงที่ปลั๊กและสายไฟจะชำรุดเสียหายได้
- **ตรวจสอบให้แน่ใจว่าสายไฟต่ออยู่ในตำแหน่งที่จะไม่ถูกเหยียบ เตะ สะดุด มิฉะนั้นอาจทำให้สายมีความตึงหรือความเสียหายได้**
- **ห้ามใช้สายต่อพ่วงโดยเด็ดขาด** เว้นแต่มีความจำเป็นอย่างหลีกเลี่ยงไม่ได้ การใช้สายต่อพ่วงที่ไม่เหมาะสมอาจทำให้เกิดเพลิงไหม้ ไฟฟ้าช็อต หรืออันตรายจากไฟฟ้าจนถึงแก่ชีวิตได้
- **อย่าวางวัตถุใดๆ บนเครื่องชาร์จหรือวางเครื่องชาร์จไว้บนพื้นผิวอ่อนนุ่มที่อาจปิดกั้นช่องระบายอากาศและทำให้เกิดความร้อนภายในที่มากเกินไป** วางเครื่องชาร์จในตำแหน่งที่ห่างจากแหล่งกำเนิดความร้อน เครื่องชาร์จมีการระบายความร้อนผ่านทางของระบายที่อยู่ด้านบนและด้านล่างของตัวเครื่อง
- **ห้ามใช้งานเครื่องชาร์จที่มีสายไฟหรือปลั๊กชำรุดเสียหาย— ให้เปลี่ยนใหม่ทันที**
- **ห้ามใช้งานเครื่องชาร์จที่ถูกกระแทกอย่างรุนแรง ตก หรือได้รับความเสียหายรูปแบบใดๆ ก็ตาม** ให้นำเครื่องชาร์จดังกล่าวไปยังศูนย์บริการที่ได้รับอนุญาต
- **ห้ามถอดชิ้นส่วนเครื่องชาร์จเอง โปรดนำเครื่องชาร์จไปยังศูนย์บริการที่ได้รับอนุญาตเมื่อจำเป็นต้องซ่อมแซมหรือรับบริการ** การประกอบเครื่องกลับดังเดิมอาจไม่ถูกต้องอาจเสี่ยงต่อการถูกไฟฟ้าช็อต อันตรายจากไฟฟ้าจนถึงแก่ชีวิต หรือเกิดเพลิงไหม้ได้
- **ในกรณีที่สายไฟของตัวเครื่องชำรุดเสียหาย สายไฟดังกล่าวต้องได้รับการเปลี่ยนโดยผู้ผลิต หรือตัวแทนศูนย์**

บริการของผู้ผลิต หรือบุคคลที่มีคุณสมบัติเทียบเท่าโดยทันที เพื่อหลีกเลี่ยงอันตรายที่อาจเกิดขึ้นได้

- **ถอดปลั๊กของเครื่องชาร์จทุกครั้งก่อนทำความสะอาดภาชนะนี้ซึ่งจะช่วยลดความเสี่ยงจากการถูกไฟฟ้าช็อตได้** การถอดก่อนแบตเตอรี่ออกจะไม่ได้
- **ทำให้ความเสี่ยงนี้ลดลง ห้ามเชื่อมต่อเครื่องชาร์จ 2 เครื่องเข้าด้วยกันโดยเด็ดขาด**
- **เครื่องชาร์จออกแบบมาเพื่อทำงานด้วยแรงดันไฟฟ้าบ้านทั่วไป 220-240 โวลต์ ห้ามนำเครื่องชาร์จไปใช้กับแรงดันไฟอื่น ๆ** ทั้งนี้ไม่รวมถึงเครื่องชาร์จสำหรับใช้ในรถยนต์

## การชาร์จแบตเตอรี่ (รูป B)

1. เสียบเครื่องชาร์จเข้ากับเต้าเสียบที่เหมาะสมก่อนที่จะใส่ก่อนแบตเตอรี่
2. ใส่ก่อนแบตเตอรี่ 10 ลงในเครื่องชาร์จ ตรวจสอบให้แน่ใจว่าใส่แบตเตอรี่ในตำแหน่งจนสุดแล้วไฟสีแดง (การชาร์จ) จะกะพริบซ้ำ ๆ เพื่อระบุว่ากระบวนการชาร์จได้เริ่มขึ้นแล้ว
3. เมื่อการชาร์จเสร็จสมบูรณ์ ไฟสีแดงจะติดสว่างอย่างต่อเนื่อง ก่อนแบตเตอรี่มีประจุไฟเต็มแล้ว และคุณอาจใช้งานแบตเตอรี่ในขณะนั้นหรือทิ้งไว้ในเครื่องชาร์จ หากต้องการถอดก่อนแบตเตอรี่ออกจากเครื่องชาร์จ ให้กดปุ่มปลดแบตเตอรี่ที่ **11** บนก่อนแบตเตอรี่

**หมายเหตุ:** เพื่อให้อุ่นใจถึงประสิทธิภาพสูงสุดและอายุการใช้งานของก่อนแบตเตอรี่ลิเทียมไอออน ให้ชาร์จก่อนแบตเตอรี่ให้เต็มก่อนใช้งานครั้งแรก

## การทำงานของเครื่องชาร์จ

อ้างอิงจากไฟแสดงสถานะด้านล่างสำหรับสถานะการชาร์จของก่อนแบตเตอรี่

### ไฟแสดงสถานะการชาร์จ

|  |                           |  |
|--|---------------------------|--|
|  | กำลังชาร์จไฟ              |  |
|  | ชาร์จเต็มแล้ว             |  |
|  | หน่วงเวลาเพื่อชาร์จ/เย็น* |  |

\* ไฟสีแดงจะยังคงกะพริบต่อเนื่อง แต่ไฟแสดงสถานะสีเหลืองจะติดสว่างในระหว่างการดำเนินการนี้เมื่อก่อนแบตเตอรี่มีอุณหภูมิที่เหมาะสมแล้ว ไฟสีเหลืองจะดับลงและเครื่องชาร์จจะเริ่มกระบวนการชาร์จต่อ

เครื่องชาร์จที่เข้ากันได้จะไม่ชาร์จก่อนแบตเตอรี่ที่ผิดปกติ หากก่อนแบตเตอรี่ผิดปกติ ไฟแสดงสถานะบนเครื่องชาร์จจะไม่ติดสว่าง

**หมายเหตุ:** ที่อาจหมายถึงปัญหาที่เกิดขึ้นกับเครื่องชาร์จ หากปรากฏว่ามีปัญหาเกิดขึ้นกับเครื่องชาร์จ ให้นำเครื่องชาร์จและแบตเตอรี่ไปทดสอบที่ศูนย์บริการซ่อมบำรุงที่ได้รับอนุญาต

### ช่วงเวลาแปะครอน/เย็น

เมื่อเครื่องชาร์จตรวจพบว่าก้อนแบตเตอรี่ร้อนหรือเย็นเกินไป เครื่องจะเริ่มการทำงานช่วงเวลาแปะครอน/เย็นโดยอัตโนมัติ หยุดการชาร์จจนกว่าแบตเตอรี่จะมีอุณหภูมิที่เหมาะสม จากนั้นเครื่องชาร์จจะสลับไปเป็นโหมดการชาร์จก้อนแบตเตอรี่โดยอัตโนมัติ คุณสมบัตินี้ช่วยให้มั่นใจถึงอายุการใช้งานสูงสุดของก้อนแบตเตอรี่

ก้อนแบตเตอรี่เย็นจะชาร์จในอัตราที่ช้ากว่าก้อนแบตเตอรี่ที่อุ่น ก้อนแบตเตอรี่จะชาร์จในอัตราที่ช้าลงตลอดรอบการชาร์จทั้งหมด และจะไม่กลับสู่อัตราการชาร์จสูงสุดแม้กระทั่งแบตเตอรี่จะอุ่นแล้วก็ตาม

เครื่องชาร์จ DCB118 มาพร้อมกับพัดลมภายในที่ออกแบบมาเพื่อทำให้ก้อนแบตเตอรี่เย็นลง พัดลมจะทำงานโดยอัตโนมัติเมื่อจำเป็นต่อระบายความร้อนของก้อนแบตเตอรี่ อย่างไรก็ตามเครื่องชาร์จหากพัดลมทำงานไม่ถูกต้องหรือมีการปิดกั้นช่องระบายอากาศ อาจปล่อยให้วัตถุแปลกปลอมเข้าไปภายในเครื่องชาร์จ

### ระบบป้องกันอิเล็กทรอนิกส์

เครื่องมือ XR Li-Ion ได้รับการออกแบบมาพร้อมกับระบบป้องกันอิเล็กทรอนิกส์ที่จะปกป้องก้อนแบตเตอรี่จากการใช้งานหนักเกินที่คิด โหลด ความร้อนสูงเกินไป หรือการคายประจุที่ลึก

เครื่องมือจะหยุดการทำงานโดยอัตโนมัติหากระบบป้องกันอิเล็กทรอนิกส์ทำงาน หากเกิดเหตุการณ์เช่นนี้ ให้วางก้อนแบตเตอรี่ทิ้งไว้บนพื้นผิวเรียบในอุณหภูมิห้องก่อนทำการติดตั้งบนผนัง

เครื่องชาร์จเหล่านี้ได้รับการออกแบบมาให้สามารถติดตั้งกับผนังหรือตั้งตรงบนโต๊ะหรือพื้นผิวการทำงาน หากติดตั้งบนผนัง ให้วางตำแหน่งเครื่องชาร์จใกล้กับเด้าเสียบและห่างจากมุมหรือสิ่งกีดขวางอื่น ๆ ซึ่งอาจขัดขวางการไหลของอากาศ ใช้น้ำหนักของเครื่องชาร์จเป็นแผนแบบเจาะสำหรับการวางตำแหน่งของสกรูยึดบนผนัง ติดตั้งเครื่องชาร์จอย่างแน่นหนาด้วยสกรูผนังเบา (ชื่อแยกต่างหาก) ยาวอย่างน้อย 25.4 มม. ด้วยหัวสกรูขนาดเส้นผ่านศูนย์กลาง 7-9 มม. โดยยึดเข้ากับไม้ด้วยความลึกที่เหมาะสม โดยปล่อยให้สกรูไหลออกมาประมาณ 5.5 มม. จัดตำแหน่งช่องด้านหลังของเครื่องชาร์จให้ตรงกับสกรูที่ไหลออกและเกี่ยวเข้ากับช่องให้สมบูรณ์

### คำแนะนำในการทำความสะอาดเครื่องชาร์จ

**!** **คำเตือน: อันตรายจากการถูกไฟฟ้าช็อต ถอดเครื่องชาร์จออกจากเต้ารับไฟบ้านก่อนทำความสะอาด** ให้ห้จัดสิ่งสกปรกและจาระบีออกจากภายนอกของเครื่องชาร์จโดยใช้ผ้าหรือแปรงขนนุ่มที่ไม่ใช่โลหะ ห้ามใช้น้ำหรือน้ำยาทำความสะอาดใดๆ อย่าให้มีของเหลวใดๆ เข้าไปในเครื่องมือเด็ดขาด ห้ามจุ่มส่วนใดๆ ของเครื่องมือลงในของเหลวเด็ดขาด

## ชุดแบตเตอรี่

### คำแนะนำเพื่อความปลอดภัยที่สำคัญสำหรับ

#### ก้อนแบตเตอรี่ทั้งหมด

เมื่อสั่งซื้อก้อนแบตเตอรี่ทดแทน โปรดตรวจให้แน่ใจว่าได้ใส่หมายเลขแคตตาล็อกและแรงดันไฟฟ้าแบบไปด้วย ผู้ผลิตไม่ได้ทำการชาร์จก้อนแบตเตอรี่ที่บรรจุอยู่ในกล่องจนเต็ม ก่อนใช้งานก้อนแบตเตอรี่และเครื่องชาร์จ โปรดอ่านคำแนะนำด้านความปลอดภัยด้านล่างจากนั้นทำตามขั้นตอนการชาร์จที่ระบุไว้

#### อ่านคำแนะนำทั้งหมด

- ห้ามชาร์จหรือใช้แบตเตอรี่ในบริเวณที่อาจเกิดการระเบิด เช่น ในบริเวณที่มีของเหลว แก๊ส หรือฝุ่น ละอองที่มีคุณสมบัติไวไฟ การใส่และถอดแบตเตอรี่ออกจากเครื่องชาร์จอาจเป็นการจุดระเบิดฝุ่นหรือไอระเหยดังกล่าวได้
- ห้ามฝืนใส่แบตเตอรี่ลงในเครื่องชาร์จ ห้ามดัดแปลงก้อนแบตเตอรี่ด้วยวิธีการใดๆ เพื่อให้สามารถใส่ลงในเครื่องชาร์จที่ไม่รองรับแบตเตอรี่นั้น เนื่องจากก้อนแบตเตอรี่อาจระเบิดขึ้นและเป็นเหตุให้ได้รับบาดเจ็บสาหัสได้
- ชาร์จแบตเตอรี่ในเครื่องชาร์จของ DEWALT ที่กำหนดเท่านั้น
- ห้ามสาดหรือจุ่มลงในน้ำหรือของเหลวใดๆ โดยเด็ดขาด
- ห้ามจัดเก็บหรือใช้งานเครื่องมือและชุดแบตเตอรี่ในสถานที่ซึ่งอุณหภูมิต่ำกว่า 4 °C (39.2 °F) (เช่น เเท็งเก็บของกลางแจ้งหรืออาคารที่เป็นโลหะในฤดูหนาว) หรืออุณหภูมิสูงกว่า 40 °C (104 °F) (เช่น เเท็งเก็บของกลางแจ้งหรืออาคารที่เป็นโลหะในฤดูร้อน)
- ห้ามเผาชุดแบตเตอรี่ แม้ว่าชุดแบตเตอรี่นั้นจะได้รับ ความเสียหายอย่างร้ายแรงหรือใช้งานจนหมดแล้วก็ตาม ชุดแบตเตอรี่สามารถระเบิดในเปลวไฟได้ และจะเกิดแก๊สพิษและสารพิษอันตรายขึ้นเมื่อแบตเตอรี่ลิเทียมไอออนถูกเผา
- หากสารภายในแบตเตอรี่สัมผัสผิวหนัง ให้รีบล้างออกด้วยน้ำสบู่อุ่นๆ ทันที หากของเหลวภายในแบตเตอรี่เข้าตา ให้ลืมนตาในน้ำเป็นเวลา 15 นาทีหรือจนไม่รู้สึกระคายเคืองอีก หากจำเป็นต้องไปพบแพทย์ สารอิเล็กทรอนิกส์ของแบตเตอรี่เป็นส่วนผสมของสารละลายคาร์บอนอินทรีย์และเกลือลิเทียม
- สารภายในแบตเตอรี่ที่ถูกเปิดออกอาจระคายเคืองต่อระบบทางเดินหายใจได้ ปรึกษาไปยังสถานที่ที่มีอากาศถ่ายเท หากอาการผิดปกติไม่หายไป ให้รีบพบแพทย์

- **!** **คำเตือน: อันตรายจากไฟไหม้** ของเหลวในแบตเตอรี่อาจติดไฟได้หากสัมผัสกับประกายไฟหรือเปลวไฟ
- **!** **คำเตือน: ห้ามพยายามแกะตัวแบตเตอรี่ในทุกกรณี** หากตัวก้อนแบตเตอรี่มีรอยแตกหรือเสียหาย ห้ามนำใส่เข้าไปในเครื่องชาร์จโดยเด็ดขาด ห้ามทุบ ทำตก

หรือทำให้ก้อนแบตเตอรี่ชำรุดเสียหาย ห้ามใช้งานแบตเตอรี่และเครื่องชาร์จที่ถูกกระแทกอย่างรุนแรง เคยตก ถูกทับ หรือได้รับความเสียหายในรูปแบบใดๆ (กล่าวคือ ถูกตะปุดอกทะลุ ถูกค้อนทุบ ถูกเหยียบจนชำรุด) เพราะอาจทำให้เกิดไฟฟ้าช็อตหรือเกิดอันตรายจากไฟฟ้างจนถึงแก่ชีวิตได้ ควรส่งแบตเตอรี่ที่ชำรุดเสียหายคืนให้ศูนย์บริการเพื่อนำไปรีไซเคิล



**คำเตือน: อันตรายจากเพลิงไหม้ อย่าเก็บหรือถือชุดแบตเตอรี่ในลักษณะที่อาจมีวัตถุที่ทำด้วยโลหะแตะถูกขั้วของแบตเตอรี่** ตัวอย่างเช่น อย่าวางชุดแบตเตอรี่ไว้ในชุดกันเปื้อน กระเป๋ากลองเครื่องมือ กลองชุดผลิตภัณฑ์ ลิ่นชก เป็นต้น เก็บรวมไว้กับตะปู สกรู กุญแจ เป็นต้น



**ข้อควรระวัง: เมื่อไม่ใช้งาน ให้วางเครื่องมือตะแคงไว้บนพื้นผิวที่มั่นคงที่จะไม่ทำให้เกิดอันตรายจากการสะดุดหรือร่วงหล่น** อุปกรณ์บางอย่างที่มีแบตเตอรี่ก้อนใหญ่อาจจะสามารถวางตั้งบนแบตเตอรี่ได้ แต่ก็อาจถูกชนล้มได้ง่ายเช่นกัน

## การขนส่ง



**คำเตือน: อันตรายจากเพลิงไหม้ การขนส่งแบตเตอรี่อาจทำให้เกิดไฟไหม้ได้** ถ้าขั้วของแบตเตอรี่สัมผัสกับวัตถุที่นำไฟฟ้า เมื่อทำการขนส่งแบตเตอรี่ต้องแน่ใจว่าขั้วแบตเตอรี่ได้รับการป้องกันและได้รับการหุ้มฉนวนอย่างดีเพื่อไม่ให้มีวัตถุใดๆ มาสัมผัสถูกและทำให้เกิดการลัดวงจรได้ **หมายเหตุ: จะต้องไม่ใส่แบตเตอรี่ลิเทียมไอออนไว้ในสัมภาระใต้ท้องเครื่อง**

แบตเตอรี่ของ DEWALT ปฏิบัติตามข้อกำหนดในการขนส่งที่บังคับใช้ตามที่บัญญัติเป็นมาตรฐานของกฎหมายและอุตสาหกรรมทุกประการ ซึ่งประกอบด้วย ข้อเสนอแนะในการขนส่งสินค้าอันตรายขององค์การสหประชาชาติ (UN Recommendations on the Transport of Dangerous Goods) เปรียบเทียบข้อบังคับของสมาคมขนส่งทางอากาศระหว่างประเทศ (IATA) ข้อกำหนดว่าด้วยการขนส่งสินค้าอันตรายระหว่างประเทศ ขององค์การทางทะเลระหว่างประเทศ (International Maritime Dangerous Goods – IMDG) และข้อตกลงร่วมกับการขนส่งสินค้าอันตรายผ่านแดนทางถนนของกลุ่มประชาคมเศรษฐกิจยุโรป (European Agreement Concerning the International Carriage of Dangerous Goods by Road – ADR) เซลล์และแบตเตอรี่ลิเทียมไอออนได้รับการทดสอบตามเกณฑ์และการทดสอบมาตรา 38.3 ของข้อเสนอแนะในการขนส่งสินค้าอันตรายขององค์การสหประชาชาติแล้ว โดยส่วนใหญ่แล้ว การขนส่งแบตเตอรี่ของ DEWALT จะได้รับยกเว้นในการจัดประเภทเป็นวัตถุอันตรายตามที่กำหนดไว้ประเภทที่ 9 โดยทั่วไปของการขนส่งที่บรรจุแบตเตอรี่ลิเทียมไอออนที่มีอัตราพลังงานไฟฟ้ามากกว่า 100 วัตต์-ชั่วโมง (Wh) จะต้องขนส่งตามที่กำหนดไว้ประเภทที่ 9 โดยต้องมีการทำเครื่องหมายแสดงอัตราวัตต์-ชั่วโมงไว้ที่หีบห่อของแบตเตอรี่ลิเทียมไอออนทั้งหมด นอกจากนี้ เนื่องจากความ

ความซับซ้อนของข้อมับังคับ DEWALT ไม่แนะนำให้ขนส่งแบตเตอรี่ลิเทียมไอออนทางอากาศเพียงอย่างเดียวโดยไม่มีคานึงถึงอัตราวัตต์-ชั่วโมง การขนส่งเครื่องมือพร้อมแบตเตอรี่ (เครื่องมือชุด) สามารถขนส่งทางอากาศได้เนื่องจากได้รับการยกเว้น หากอัตราวัตต์-ชั่วโมงของชุดแบตเตอรี่ไม่เกิน 100 วัตต์-ชั่วโมง

ทั้งนี้ โดยไม่คำนึงว่าการขนส่งจะได้รับยกเว้นหรือต้องปฏิบัติตามอย่างครบถ้วน เป็นความรับผิดชอบของผู้ขนส่งที่จะต้องค้นหาข้อมูลเกี่ยวกับข้อมับังคับด้านบรรจุกฎที่ล่าสุด ข้อกำหนดเรื่องการแสดงฉลาก/เครื่องหมายและการจัดเตรียมเอกสาร

ข้อมูลในหัวข้อนี้ได้รับการจัดเตรียมโดยสุจริตและเชื่อมั่นว่าถูกต้องในเวลาที่ทำขึ้น อย่างไรก็ตามไม่ถือว่าเป็นการรับประกันทั้งโดยชัดแจ้งหรือโดยปริยาย เป็นความรับผิดชอบของผู้ซื้อที่จะตรวจสอบให้แน่ใจว่ากิจกรรมต่างๆ ของบริษัทสอดคล้องตามข้อกำหนดที่บังคับใช้ **การขนส่งแบตเตอรี่ FLEXVOLT™**

แบตเตอรี่ DEWALT FLEXVOLT™ มีสองโหมด: **การใช้และการขนส่ง**

**โหมดการใช้งาน:** เมื่อแบตเตอรี่ FLEXVOLT™ แยกออกโดยเด็ดขาดหรืออยู่ในผลิตภัณฑ์ DEWALT 18V แบตเตอรี่จะทำงานเป็นแบตเตอรี่ 18V เมื่อแบตเตอรี่ FLEXVOLT™ อยู่ ในผลิตภัณฑ์ 54V หรือ 108V (แบตเตอรี่ 54V สองก้อน) แบตเตอรี่จะทำงานเป็นแบตเตอรี่ 54V

**โหมดการขนส่ง:** เมื่อติดตั้งฝาครอบกับแบตเตอรี่ FLEXVOLT™ ซึ่งแบตเตอรี่อยู่ในโหมดการขนส่งให้เก็บรักษาฝาครอบสำหรับจัดส่ง

เมื่ออยู่ในโหมดการขนส่ง สตรีงของเซลล์จะถูกตัดการเชื่อมต่อทางไฟฟ้าภายในก่อน แบตเตอรี่ ทำให้แบตเตอรี่ 3 ก้อนที่มีพัลส์วัตต์-ชั่วโมง (Wh) ต่ำลงเมื่อเปรียบเทียบกับแบตเตอรี่ 1 ก้อนที่มีพัลส์วัตต์-ชั่วโมงสูงกว่า มีการยกเว้นปริมาณที่เพิ่มขึ้นของแบตเตอรี่ 3 ก้อนที่มีพัลส์วัตต์-ชั่วโมงต่ำกว่าจากข้อมับังคับการขนส่งที่กำหนดไว้สำหรับแบตเตอรี่ที่มีพัลส์วัตต์-ชั่วโมงสูงกว่า ตัวอย่างเครื่องหมายฉลากเกี่ยวกับการใช้งานและการขนส่ง



สำหรับการขนส่งอาจได้รับการระบุเป็น 3 x 36 Wh ซึ่งหมายถึงความถ่วง

**Use: 108 Wh**  
**Transport: 3x36 Wh**

แบตเตอรี่จำนวน 3 ลูกโดยที่แต่ละลูกมีกำลังเท่ากับ 36 Wh การใช้กำลัง Wh อาจได้รับการแสดงเป็น 108 Wh (หมายถึงแบตเตอรี่ 1 ลูก)

## คำแนะนำในการเก็บรักษา

1. สถานที่เก็บรักษาอุปกรณ์ที่เหมาะสมที่สุดคือสถานที่ซึ่งแห้งและเย็น ไม่ได้รับแสงอาทิตย์โดยตรง และอุณหภูมิไม่ร้อนหรือเย็นมากเกินไป เพื่อให้ประสิทธิภาพและอายุการใช้งานของแบตเตอรี่ยาวนานสูงสุด ควรเก็บรักษาแบตเตอรี่ในอุณหภูมิห้องเมื่อไม่ใช้งาน

2. กรณีเก็บเป็นเวลานาน ให้เก็บแบตเตอรี่ที่ชาร์จเต็มแล้ว  
ในสถานที่แห้งและเย็นนอกเครื่องชาร์จ

หมายเหตุ: ไม่ควรเก็บรักษาชุดแบตเตอรี่ในสภาพปราศจากประจุ  
โดยสิ้นเชิง จำเป็นต้องชาร์จแบตเตอรี่ใหม่อีกครั้งก่อนใช้งาน

### แผ่นป้ายบนแบตเตอรี่และเครื่องชาร์จ

นอกเหนือจากสัญลักษณ์ภาพที่ใช้ในคู่มือเล่มนี้แล้ว บนเครื่อง  
ชาร์จและแบตเตอรี่จะมีสัญลักษณ์ภาพดังต่อไปนี้



โปรดอ่านคู่มือแนะนำการใช้ก่อนใช้งาน



โปรดดูข้อมูลทางเทคนิคสำหรับเวลาชาร์จ



ห้ามแยกด้วยวัตถุที่เป็นตัวนำ



ห้ามชาร์จแบตเตอรี่ที่ชำรุด



ห้ามทำให้แบตเตอรี่เปียกน้ำ



เปลี่ยนสายไฟที่ชำรุดทันที



ชาร์จไฟที่อุณหภูมิระหว่าง 4 °C ถึง 40 °C เท่านั้น



ใช้ภายในอาคารเท่านั้น



โปรดทิ้งแบตเตอรี่อย่างเหมาะสมโดยคำนึงถึง  
ผลกระทบต่อสิ่งแวดล้อม



ชาร์จแบตเตอรี่ DEWALT กับเครื่องชาร์จของ  
DEWALT ที่กำหนดเท่านั้น การชาร์จแบตเตอรี่  
ชนิดอื่นนอกเหนือจากแบตเตอรี่ DEWALT  
กำหนดกับเครื่องชาร์จ DEWALT อาจทำให้  
แบตเตอรี่ระเบิดหรือนำไปสู่สถานการณ์ที่เป็น  
อันตรายอื่นๆ



ห้ามเผาแบตเตอรี่



โหมดการใช้งาน (โดยไม่มีฝาครอบการขนส่ง)  
ตัวอย่าง: พิกัด Wh ระบุ 108 Wh (แบตเตอรี่ 1 ก้อน  
โดยมีขนาด 108 Wh)



โหมดการขนส่ง (พร้อมฝาปิดการขนส่งในตัว)  
ตัวอย่าง: พิกัด Wh ระบุ 3 x 36 Wh (แบตเตอรี่ 3  
ก้อน โดยแต่ละก้อนมีขนาด 36 Wh)

### ชนิดของแบตเตอรี่

เครื่องมือดังต่อไปนี้ทำงานโดยใช้ชุดแบตเตอรี่แรงดัน  
ไฟฟ้าสูงสุด 18/20:DCG409

คุณสามารถใช้งานก่อนแบตเตอรี่เหล่านี้ได้: DCB181, DCB182,  
DCB183, DCB183B, DCB184, DCB184B, DCB185, DCB186,  
DCB187, DCB189, DCB203, DCB204, DCB205, DCB240,  
DCB546, DCB547, DCB548, DCB606, DCB609, DCB612  
อ้างอิง ตามข้อมูลทางเทคนิคสำหรับข้อมูลเพิ่มเติม

### สิ่งที่อยู่ในบรรจุภัณฑ์

ภายในบรรจุภัณฑ์ประกอบด้วย:

- 1 เครื่องเจียร์ไฟฟ้า
- 1 อุปกรณ์ป้องกันขนาด 125 มม (ประเภท 27)
- 1 คัมจับด้านข้าง
- 1 ชุดหน้าแปลน
- 1 ประแจหกเหลี่ยม
- 1 ก้อนแบตเตอรี่ Li-Ion (รุ่น C1, D1, L1, M1, P1, S1, T1, X1, Y1)
- 2 ก้อนแบตเตอรี่ Li-Ion (รุ่น C2, D2, L2, M2, P2, S2, T2, X2, Y2)
- 3 ก้อนแบตเตอรี่ Li-Ion (รุ่น C3, D3, L3, M3, P3, S3, T3, X3, Y3)
- 1 คู่มือการใช้งาน

หมายเหตุ: รุ่น N จะไม่มีชุดแบตเตอรี่ ที่ชาร์จและกล่องเครื่องมือ  
ให้คุณ รุ่น NT จะไม่มีชุดแบตเตอรี่และที่ชาร์จให้คุณ รุ่น B จะมีชุด  
แบตเตอรี่ Bluetooth® ให้คุณ

หมายเหตุ: เครื่องหมายถ้อยคำและโลโก้ของ Bluetooth® ถือเป็น  
เครื่องหมายการค้าจดทะเบียนซึ่งเป็นของ Bluetooth®, SIG, Inc. การ  
ใช้เครื่องหมายดังกล่าวโดย DEWALT อยู่ภายใต้ใบอนุญาตในขณะที่  
ที่เครื่องหมายการค้าและชื่อการค้าอื่นๆ จะถือว่าเป็นของเจ้าของ  
ที่เกี่ยวข้อง

- โปรดตรวจหาร่องรอยความเสียหายของเครื่องมือ ชิ้น  
ส่วน หรืออุปกรณ์เสริม ที่อาจเกิดขึ้นในระหว่างการขนส่ง
- โปรดอ่านและทำความเข้าใจคู่มือเล่มนี้ก่อนการใช้งาน

### สัญลักษณ์บนเครื่องมือ

รูปภาพต่อไปนี้จะปรากฏบนเครื่องมือ:



โปรดอ่านคู่มือแนะนำการใช้ก่อนใช้งาน



สวมอุปกรณ์ป้องกันเสียงดัง



สวมอุปกรณ์ป้องกันดวงตา

### ตำแหน่งของรหัสรุ่น (รูป E)

รหัสรุ่น **12** ซึ่งรวมถึง ปีที่ผลิต จะพิมพ์ไว้บนตัวเครื่อง  
ตัวอย่างเช่น:

2021 XX XX

ปีและสัปดาห์ของการผลิต

### คำอธิบาย (รูป A)



**คำเตือน:** ห้ามดัดแปลงเครื่องมือไฟฟ้าหรือส่วน  
ประกอบต่างๆ เพราะอาจทำให้เครื่องมือชำรุดหรือได้  
รับบาดเจ็บได้

- 1 สวิตช์เลื่อน
- 2 คันโยกสำหรับลีด
- 3 ปุ่มลีดคแกนหมุน
- 4 แกนหมุน
- 5 ตามจับด้านข้าง
- 6 หน้าแปลนเหล็ก
- 7 หน้าแปลนลีด
- 8 อุปกรณ์ป้องกัน
- 9 คันโยกปล่อยอุปกรณ์ป้องกัน
- 10 ชุดแบตเตอรี่
- 11 ปุ่มปลดลีดคแบตเตอรี่

## วัตถุประสงค์ในการใช้งาน

เครื่องเจียร์ไฟฟ้าไร้สายรุ่น DCG409 ได้รับการออกแบบมาสำหรับการตัด การเจียร์ การขีด และการแปรงลวดแบบมีมืออาชีพ

ห้ามใช้งาน หากอยู่ในบริเวณที่เปียกชื้นหรือมีของเหลว ไวไฟหรือแก๊สอยู่ในบริเวณดังกล่าว

เครื่องเจียร์ไฟฟ้าไร้สายนี้เป็นเครื่องมือไฟฟ้าสำหรับมืออาชีพ

ห้ามปล่อยให้เด็กสัมผัสกับเครื่องมือ ผู้ใช้ที่ไม่มีประสบการณ์มาก่อนต้องได้รับการดูแลในขณะที่ใช้เครื่องมือนี้

- ผู้เยาว์และผู้ที่มีความเชี่ยวชาญ เครื่องมือนี้ไม่ได้มีไว้เพื่อการใช้งานโดยผู้เยาว์หรือผู้ที่มีความเชี่ยวชาญโดยไม่มีการควบคุมดูแล
- เครื่องมือนี้ไม่ได้มีไว้เพื่อการใช้งานโดยบุคคล (ซึ่งรวมถึงผู้เยาว์) ที่มีความบกพร่องทางร่างกาย ทางารรับความรู้สึก หรือทางจิตประสาท หรือขาดประสบการณ์ ความรู้ และทักษะ เว้นเสียแต่จะได้รับการควบคุมดูแล หรือคำแนะนำการใช้เครื่องมือโดยผู้ที่รับผิดชอบต่อความปลอดภัยของบุคคลเหล่านั้น ห้ามปล่อยให้ผู้เยาว์ไว้กับเครื่องมือนี้ตามลำพัง

## คุณลักษณะเด่น

### สวิตช์แบบไม่มีแรงดันไฟฟ้า

ฟังก์ชันการไม่มีแรงดันไฟฟ้าจะทำให้เครื่องเจียร์ไม่รีสตาร์ทเครื่องหากไม่มีการหมุนสวิตช์ในกรณีที่เกิดความเสียหายในแหล่งจ่ายไฟ

### คลัตช์อีเล็กทรอนิกส์

เครื่องมือนี้ได้รับการติดตั้งมาพร้อมกับ E-Clutch™ (คลัตช์อิเล็กทรอนิกส์) ในกรณีเกิดการโหลดสูงหรือการหนีบของใบเจียร์ เครื่องมือจะถูกปิดเพื่อลดแรงบิดปฏิกิริยาที่เกิดขึ้นผู้ใช้ ทั้งนี้ คุณจะต้องหมุนสวิตช์ (การเปิดและการปิดเครื่อง) เพื่อรีสตาร์ทเครื่องมือ

### Kickback Brake™

เมื่อเกิดการหนีบ การหยุดชะงัก หรือการพันขึ้น เบรคอิเล็กทรอนิกส์จะใช้แรงสูงสุดเพื่อหยุดใบเจียร์อย่างรวดเร็ว รวมถึงลดการเคลื่อนไหวของเครื่องเจียร์ และปิดเครื่อง

เจียร์ คุณจะต้องปล่อยสวิตช์ก่อน จากนั้นจึงกดสวิตช์เพื่อรีสตาร์ทเครื่องมือ

## การป้องกันการโอเวอร์โหลด Power-OFF™

การจ่ายไฟให้แก่มอเตอร์จะลดลงในกรณีที่มอเตอร์โอเวอร์โหลด หากมอเตอร์ยังคงโอเวอร์โหลดต่อไป เครื่องมือจะดับลง คุณจะต้องปล่อยสวิตช์ก่อน จากนั้นจึงกดสวิตช์เพื่อรีสตาร์ทเครื่องมือ เครื่องมือจะดับลงในทุกครั้งที่โหลดไฟฟ้าขึ้นถึงค่ากระแสไฟฟ้าโอเวอร์โหลด (จุดเผาไหม้ของมอเตอร์) หากเกิดการปิดเครื่องเนื่องจากการโอเวอร์โหลดอย่างต่อเนื่อง คุณจะต้องใช้แรง/น้ำหนักกับเครื่องมือให้น้อยลงจนกระทั่งเครื่องมือทำงานโดยไม่มีการโอเวอร์โหลด

## ฟีเจอร์ Soft Start

ฟีเจอร์ Soft Start จะช่วยให้เกิดการสะสมความเร็วต่ำเพื่อหลีกเลี่ยงการกระตุกเมื่อเริ่มต้นทำงาน ฟีเจิร์นีจะมีประโยชน์เป็นอย่างมากโดยเฉพาะอย่างยิ่งเมื่อทำงานในพื้นที่อับอากาศ

## ตามจับด้านข้างป้องกันการสั่นสะเทือน

ตามจับด้านข้างป้องกันการสั่นสะเทือนจะให้ความสะดวกที่มากขึ้นแก่ผู้ใช้เนื่องจากจะดูดซับการสั่นสะเทือนที่เกิดจากเครื่องมือ

## การประกอบและการปรับแต่ง

**⚠ คำเตือน:** เพื่อลดความเสี่ยงจากการได้รับบาดเจ็บรุนแรง ต้องปิดเครื่องมือและถอดปลั๊กออกจากแหล่งจ่ายไฟก่อนทำการปรับตั้ง หรือทำการถอด/ติดตั้งอุปกรณ์ยึดติดหรืออุปกรณ์เสริมใดๆ ทุกครั้ง การเผลอเปิดเครื่องโดยไม่ตั้งใจอาจเป็นสาเหตุให้เกิดการบาดเจ็บได้

**⚠ คำเตือน:** ใช้แบตเตอรี่และเครื่องชาร์จของ DEWALT เท่านั้น

## การใส่และถอดก้อนแบตเตอรี่ออกจากเครื่องมือ (รูป B)

หมายเหตุ: ต้องตรวจให้แน่ใจว่าแบตเตอรี่แพ็ค 10 ของคุณชาร์จจนเต็มแล้ว

### ในการติดตั้งชุดแบตเตอรี่ลงในที่จับเครื่องมือ

1. จัดแนวแบตเตอรี่ 10 ให้ตรงกับรางด้านในที่จับของเครื่องมือ (รูป B)
2. เลื่อนเข้าไปในที่จับจนกระทั่งก้อนแบตเตอรี่ฝังอยู่ในเครื่องมืออย่างแน่นสนิท และเพื่อความแน่ใจ คุณจะได้ยินเสียงลีดลีดเข้าที่

### วิธีการถอดแบตเตอรี่ออกจากเครื่องมือ

1. กดปุ่มปลดลีดค 11 และดึงแบตเตอรี่ออกจากมือจับเครื่องมืออย่างมีกำลัง
2. ใส่ก้อนแบตเตอรี่ลงในเครื่องชาร์จตามที่ได้อธิบายไว้ในส่วนของเครื่องชาร์จของคุณ

### ชุดมาตรฐานวัดพลังงานแบตเตอรี่ (รูป C)

แบตเตอรี่ของ DEWALT บางรุ่นมีมาตรฐานวัดพลังงานซึ่งประกอบด้วยไฟ LED สีเขียวสามดวงที่จะระบุระดับประจุที่เหลืออยู่ในก้อนแบตเตอรี่

เพื่อกระตุนมาตรฐานวัดพลังงาน 19 กดปุ่มมาตรฐานค่าจวไฟ LED สีเขียวสามดวงที่รวมตัวกันจะส่องสว่างเพื่อกำหนดระดับประจุที่เหลือเมื่อระดับประจุไฟฟ้ในแบตเตอรี่ต่ำกว่าขีดจำกัดที่ใช้งานได้ มาตรฐานจะไม่ติดและต้องทำการชาร์จแบตเตอรี่ใหม่

**หมายเหตุ:** มาตรฐานวัดพลังงานเป็นเพียงการบ่งบอกถึงประจุที่เหลืออยู่ในก้อนแบตเตอรี่ซึ่งไม่ได้บ่งบอกถึงการทำงานของเครื่องมือ และอาจมีการเปลี่ยนแปลงตามส่วนประกอบของผลิตภัณฑ์ อุดหนุุมและการใช้งานของผู้ใช้

### การใส่ด้ามจับด้านข้าง (รูป C)

**!** **คำเตือน:** ก่อนใช้เครื่องมือ คุณจะต้องตรวจสอบว่า คุณได้ขันด้ามจับจนแน่นหรือไม

ขั้นสกรูของด้ามจับด้านข้าง 5 เข้าไปในรูใดรูหนึ่งบนด้านใดด้านหนึ่งของกระปุกเกียร์ให้แน่น คุณจะต้องใช้ด้ามจับด้านข้างอยู่เสมอเพื่อให้สามารถกดว้ซึ่งการควบคุมเครื่องมืออยู่ตลอดเวลาได้

### การหมุนกระปุกเกียร์ (รูป D)

กระปุกเกียร์จะหมุนที่ 90 องศาสำหรับการตัดเพื่อให้อู้ใช้เกิดความสะดวกมากขึ้น

1. ถอดสกรูยึดมุมทั้งสี่ตัวซึ่งยึดกระปุกเกียร์กับตัวเรือนมอเตอร์ออก
2. หมุนส่วนหัวของกระปุกเกียร์ไปยังตำแหน่งที่ต้องการโดยไม่ต้องแยกกระปุกเกียร์ออกจากตัวเรือนมอเตอร์

**หมายเหตุ:** หากกระปุกเกียร์และตัวเรือนมอเตอร์ถูกแยกออกจากกันมากกว่า 3.17 มม. เครื่องมือจะต้องได้รับการบำรุงรักษาและประกอบใหม่โดยศูนย์บริการของ DEWALT ทั้งนี้ การไม่บำรุงรักษาเครื่องมือจะทำให้หม้อเตอร์และดลล์สึกป็นไม่ทำงาน ใส่สกรูเข้าไปใหม่เพื่อยึดกระปุกเกียร์เข้ากับตัวเรือนมอเตอร์

3. ขั้นสกรูให้ม้แรงบิด 12.5 นิว-ปอนด์ ทั้งนี้ การขันสกรูแน่นเกินไปจะทำให้สกรูเสียหายได้

### อุปกรณ์ป้องกัน

**!** **ข้อควรระวัง:** **คุณจะต้องใช้อุปกรณ์ป้องกันกับหินเจียร ใบตัด ใบเจียรผ้าทรายข้อน แปรงลาด และแปรงลาดกลมทั้งหมด** คุณสามารถใช้เครื่องมือโดยปราศจากอุปกรณ์ป้องกันได้ในกรณีที่คุณทำการขีดทรายโดยใช้แผ่นขีดทรายทั่วไป ดูที่รูป A เพื่อดูอุปกรณ์ป้องกันซึ่งได้รับการจัดหามาให้พร้อมกับเครื่องมือ อนึ่ง คุณอาจต้องซื้ออุปกรณ์ป้องกันที่เหมาะสมสำหรับการทำงานบางประเภทจากตัวแทนจำหน่ายหรือศูนย์บริการที่ได้รับการอนุญาตในท้องถิ่นของคุณ

**หมายเหตุ:** คุณจะต้องทำการเจียรและการตัดขอบโดยใช้ใบเจียรประเภท 27 ซึ่งได้รับการกำหนดและออกแบบมาเพื่อวัตถุประสงค์นี้ ใบเจียรซึ่งมีความหนา 6.35 มม. ได้รับการออกแบบมาสำหรับการเจียรพื้นผิว ในขณะที่คุณจะต้องตรวจสอบใบเจียรประเภท 27 ซึ่งบางกว่ากับเวลาของผลิตเพื่อดูว่า คุณสามารถใช้ใบเจียรดังกล่าวกับการเจียรพื้นผิวหรือการเจียร/การตัดขอบได้หรือไม่ คุณจะต้องใช้อุปกรณ์ป้องกันประเภท 1 สำหรับใบเจียรซึ่งห้ามไม่ให้มีการเจียรพื้นผิว คุณสามารถทำการตัดได้โดยใช้ใบเจียรประเภท 41 และอุปกรณ์ป้องกันประเภท 1

**หมายเหตุ:** ดูที่ **แผนภูมิอุปกรณ์เสริม** เพื่อเลือกการรวมอุปกรณ์ป้องกัน/อุปกรณ์เสริมที่เหมาะสม

### การใส่และการปรับอุปกรณ์ป้องกัน One-Touch™ (รูป E)

**!** **คำเตือน:** **คุณจะต้องปิดเครื่องมือและตัดการเชื่อมต่อชุดแบตเตอรี่ก่อนที่จะทำการปรับแต่งหรือทำการถอด/ใส่อุปกรณ์ต่อพ่วงหรืออุปกรณ์เสริมเพื่อลดความเสี่ยงในการบาดเจ็บส่วนบุคคลที่สาหัส** การเริ่มต้นทำงานโดยไม่เจตนาอาจทำให้เกิดการบาดเจ็บได้

### การปรับแต่งอุปกรณ์ป้องกัน

ในส่วนของการปรับแต่งอุปกรณ์ป้องกันนั้น ดันโยกปล่อยอุปกรณ์ป้องกัน 9 จะยึดรูวางตำแหน่ง 15 รูใดรูหนึ่งบนปลอกของอุปกรณ์ป้องกันโดยใช้พีเจอรการหมุนไปในทิศทางเดียวกัน

หน้าที่ยึดจะเฉียงและจะคล่อมไปที่รูวางตำแหน่งถัดไปเมื่อคุณหมุนอุปกรณ์ป้องกันตามเข็มนาฬิกา (แกนหมุนหันไปทางผู้ใช้) แต่จะล็อกตัวเองในทิศทางทวนเข็มนาฬิกา

### การใส่อุปกรณ์ป้องกัน (รูป E)

1. กดคันโยกปล่อยอุปกรณ์ป้องกัน 9
2. ในขณะที่คันโยกปล่อยอุปกรณ์ป้องกันเปิดอยู่ จัดส่วนที่ยื่นออกมา 13 บนอุปกรณ์ป้องกันให้อยู่ตรงกันกับช่อง 14 บนกระปุกเกียร์
3. ดูแลให้คันโยกปล่อยอุปกรณ์ป้องกันเปิดอยู่เสมอ ดันอุปกรณ์ป้องกันลงจนกระทั่งส่วนที่ยื่นออกมาของอุปกรณ์ป้องกันเข้าที่ หมุนส่วนที่ยื่นออกมามาตั้งกล่าวในร่องบนกระปุกเกียร์ และปล่อยคันโยกปล่อยอุปกรณ์ป้องกัน
4. เมื่อแกนหมุนหันหน้าเข้าหาผู้ปฏิบัติงาน ให้คุณหมุนอุปกรณ์ป้องกันไปตามเข็มนาฬิกาเข้าไปในตำแหน่งการทำงานที่ต้องการ กดคันโยกปล่อยอุปกรณ์ป้องกัน 9 ค้างไว้เพื่อหมุนอุปกรณ์ป้องกันไปในทิศทางทวนเข็มนาฬิกา

**หมายเหตุ:** อุปกรณ์ป้องกันจะต้องได้รับการวางตำแหน่งให้อยู่ที่ระหว่างแกนหมุนกับผู้ปฏิบัติงานเพื่อให้เกิดการปกป้องสูงสุดแก่ผู้ปฏิบัติงาน คันโยกปล่อยอุปกรณ์ป้องกันจะต้องเข้าไปในรูวางตำแหน่ง 15 รูใดรูหนึ่งบนปลอกของอุปกรณ์ป้องกัน การทำเช่นนี้จะช่วยให้อุ่นใจได้ว่าอุปกรณ์ป้องกันยึดแน่น



- ปฏิบัติตามขั้นตอน 1-3 ของคำแนะนำแบบสลบขั้นตอน เพื่อทำการถอดอุปกรณ์ป้องกัน

## หน้าแปลนและใบเจียร

### การใส่ใบเจียรแบบไม่มีดุม (รูป F)

**!** คำเตือน: การไม่สามารถใส่หน้าแปลน/น็อตยึด/ใบเจียรให้เข้าที่อย่างเหมาะสมอาจทำให้เกิดการบาดเจ็บสาหัส (หรือเกิดความเสียหายกับเครื่องมือหรือใบเจียร) ได้

**!** ข้อควรระวัง: คุณจะต้องใช้หน้าแปลนที่จัดหาให้มากกว่าศูนย์กลางที่ถูกดัดประเภท 27 นิ้วเจียรประเภท 42 และใบตัดประเภท 41 ดูที่ **แผนภาพอุปกรณ์เสริม** สำหรับข้อมูลเพิ่มเติม

**!** คำเตือน: คุณจะต้องใช้อุปกรณ์ป้องกันสำหรับใบตัดสองด้านแบบปิดเมื่อใช้ใบตัด

**!** คำเตือน: การใช้หน้าแปลนหรืออุปกรณ์ป้องกันที่ชำรุดเสียหาย หรือการไม่ใช้หน้าแปลนและอุปกรณ์ป้องกันที่เหมาะสมจะทำให้เกิดการบาดเจ็บเนื่องจากการแตกหักของใบตัดและการสัมผัสกับใบตัดได้ ดูที่ **แผนภาพอุปกรณ์เสริม** สำหรับข้อมูลเพิ่มเติม

- วางเครื่องมือลงบนโต๊ะ เตรียมอุปกรณ์ป้องกัน
- ใส่หน้าแปลนเหล็ก 6 บนแกนหมุน 4 โดยให้ตรงกลางที่ยกขึ้น (นาร่อง) หันหน้าไปทางใบตัด กอดหน้าแปลนเหล็กให้เข้าที่
- วางใบตัด 20 ลงไปที่หน้าแปลนเหล็ก ให้ใบตัดอยู่ตรงกลางของตรงกลางที่ยกขึ้น (นาร่อง) ของหน้าแปลนเหล็ก
- ในขณะที่กดปุ่มล็อคแกนหมุนโดยให้ส่วนที่กดรูปทรงแหลมหันหน้าออกไปจากใบตัด ให้คุณร้อยหน้าแปลนล็อค 7 บนแกนหมุนเพื่อให้ส่วนที่ยื่นออกมาเข้าไปในทั้งสองช่องในแกนหมุน
- ในขณะที่กดปุ่มล็อคแกนหมุน ให้คุณขันหน้าแปลนล็อค 7 โดยใช้มือ หรือใช้ประแจซึ่งจัดหามาให้
- (ใช้เฉพาะหน้าแปลนล็อคหากหน้าแปลนล็อคดังกล่าวอยู่ในสภาพที่สมบูรณ์แบบเท่านั้น) ดูที่ **แผนภาพอุปกรณ์เสริม** เพื่อดูรายละเอียดเกี่ยวกับหน้าแปลน
- ทำตามขั้นตอนข้างต้นแบบสลบลำดับเพื่อถอดใบตัด

### การใส่แผ่นขัดทราย (รูป G)

**หมายเหตุ:** คุณไม่จำเป็นต้องใช้อุปกรณ์ป้องกันกับแผ่นขัดทรายที่ใช้แผ่นขัดหรือที่มักเรียกกันว่าแผ่นไฟเบอร์เรซิน เนื่องจากคุณไม่ต้องการใช้อุปกรณ์ป้องกันสำหรับอุปกรณ์เสริมดังกล่าว อุปกรณ์ป้องกันอาจจะไม่ได้รับการใส่อย่างถูกต้องหากมีการใช้อุปกรณ์ป้องกัน

**!** คำเตือน: การไม่สามารถใส่หน้าแปลน/น็อตยึด/ใบเจียรให้เข้าที่อย่างเหมาะสมอาจทำให้เกิดการบาดเจ็บสาหัส (หรือเกิดความเสียหายกับเครื่องมือหรือใบเจียร) ได้



**คำเตือน:** คุณจะต้องใส่อุปกรณ์ป้องกันที่เหมาะสมสำหรับหินเจียร ใบตัด ใบเจียรผ้าทรายซ้อน แปรงลวด หรือแปรงลวดกลมกลับเข้าไปอีกครั้งหลังจากทำการขัดทรายเรียบร้อยแล้ว

- วางหรือร้อยแผ่นเหล็ก 17 บนแกนหมุนอย่างเหมาะสม
- วางแผ่นขัดทราย 18 บนแผ่นขัด 17
- ในขณะที่กดปุ่มล็อคแกนหมุน 3 ให้คุณร้อยน็อตยึด 16 บนแกนหมุนโดยการนาร่องดุมที่กดขึ้นมาบนน็อตยึดไปที่ตรงกลางของแผ่นขัดทรายและแผ่นขัด
- ขันน็อตยึดโดยใช้มือ จากนั้นจึงกดปุ่มล็อคแกนหมุนในขณะที่หมุนแผ่นขัดทรายจนกระทั่งแผ่นขัดทรายกับน็อตยึดเข้าที่
- หากต้องการถอดใบเจียร ให้คุณจับและหมุนแผ่นขัดและแผ่นขัดทรายในขณะที่กดปุ่มล็อคแกนหมุน

### การใส่และการถอดใบเจียรแบบมีดุม (รูป F)

ใส่ใบเจียรแบบมีดุมบนแกนหมุนเกลียวโดยตรง เกลียวของอุปกรณ์เสริมจะต้องตรงกันกับเกลียวของด้ามจับ

- ถอดหน้าแปลนเหล็กโดยการดึงหน้าแปลนเหล็กออกจากเครื่องมือ
- ร้อยใบเจียรบนแกนหมุน 4 โดยใช้มือ
- กดปุ่มล็อคแกนหมุน 3 และใช้ประแจขันดุมของใบเจียรให้แน่น
- สลบขั้นตอนข้างต้นเพื่อทำการถอดใบเจียร

**หมายเหตุ:** การไม่สามารถใส่ใบเจียรให้เข้าที่อย่างเหมาะสมก่อนที่จะหมุนเครื่องมืออาจทำให้เครื่องมือหรือใบเจียรเสียหายได้

### การใส่แปรงลวดถั่วและแปรงลวดกลม (รูป A)

**!** คำเตือน: การไม่สามารถใส่หน้าแปลน/น็อตยึด/ใบเจียรให้เข้าที่อย่างเหมาะสมอาจทำให้เกิดการบาดเจ็บสาหัส (หรือเกิดความเสียหายกับเครื่องมือหรือใบเจียร) ได้

**!** ข้อควรระวัง: เพื่อลดความเสี่ยงของการบาดเจ็บส่วนบุคคล คุณจะต้องสวมถุงมือสำหรับการทำงานเมื่อจัดการกับแปรงลวดและแปรงลวดกลม เนื่องจากแปรงดังกล่าวมีความคม

**!** ข้อควรระวัง: เพื่อลดความเสี่ยงของความเสี่ยงที่มีต่อเครื่องมือ ใบเจียรหรือแปรงจะต้องไม่สัมผัสกับอุปกรณ์ป้องกันเมื่อมีการใส่หรือในขณะที่กำลังใช้งาน ทั้งนี้ ความเสียหายที่ตรวจไม่พบอาจเกิดขึ้นกับอุปกรณ์เสริมและทำให้ลวดแตกออกจากใบเจียรหรือถั่วของอุปกรณ์เสริมได้

ใส่แปรงลวดถั่วหรือแปรงลวดกลมบนแกนหมุนเกลียวโดยตรงโดยไม่จำเป็นต้องใช้หน้าแปลน ใช้แปรงลวดหรือแปรงลวดกลมที่ใหม่กับดุมเกลียว คุณสามารถซื้ออุปกรณ์เสริมดังกล่าวได้จากตัวแทนจำหน่ายหรือศูนย์บริการที่ได้รับอนุญาตในท้องถิ่นของคุณ



1. วางเครื่องมือลงบนโต๊ะ เตรียมอุปกรณ์เบื้องต้น
  2. ร้อยใบเจียรบนแกนหมุนโดยใช้มีด
  3. กดปุ่มล็อคแกนหมุน 3 และใช้ประแจบนคมของของแปรงลวดกลมหรือแปรงลวดเพื่อขันใบเจียรให้แน่น
  4. ทำตามขั้นตอนข้างต้นแบบสลับลำดับเพื่อถอดใบเจียร
- หมายเหตุ:** ใส่คมของใบเจียรให้เข้าที่ก่อนที่จะเปิดเครื่องมือเพื่อลดความเสี่ยงของความปลอดภัยที่มีต่อเครื่องมือ

### ก่อนการใช้งาน



- ใส่อุปกรณ์ป้องกันและใบเจียรหรือหินเจียรที่เหมาะสม ห้ามใช้ใบเจียรหรือหินเจียรที่สึกหรอมากเกินไป
- ตรวจสอบให้แน่ใจว่า คุณได้ใส่หน้าแปลนเหล็กและหน้าแปลนลวดค้อย่างถูกต้อง ปฏิบัติตามคำแนะนำต่างๆ ซึ่งระบุไว้ใน **แผนภาพอุปกรณ์เสริม**
- ตรวจสอบให้แน่ใจว่า ใบเจียรหรือหินเจียรหมุนไปในทิศทางเดียวกันกับลูกศรบนอุปกรณ์เสริมและเครื่องมือ
- ห้ามใช้อุปกรณ์เสริมที่ชำรุดเสียหาย ก่อนการใช้งานในแต่ละครั้ง คุณจะต้องตรวจสอบอุปกรณ์เสริม เช่น ตรวจสอบล้อขัดว่ามีการกระแทกและรอยแตกหรือไม่ ตรวจสอบแผ่นขัดว่ามีรอยแตก การฉีกขาดหรือการสึกหรอที่มากเกินไปหรือไม่ และตรวจสอบแปรงลวดเพื่อดูว่าลวดหลวมหรือแตกออกหรือไม่ หากเครื่องมือไฟฟ้าหรืออุปกรณ์เสริมตกลงพื้น คุณจะต้องตรวจสอบความเสียหาย หรือใส่อุปกรณ์เสริมที่ไม่ชำรุดเสียหาย หลังจากตรวจสอบและใส่อุปกรณ์เสริมแล้ว คุณและผู้ที่ยืนดูจะต้องอยู่ในไกลจากระนาบของอุปกรณ์เสริมที่กำลังหมุนและใช้งานเครื่องมือไฟฟ้าที่ความเร็วสูงสุดแบบไม่มีโหลดเป็นเวลาหนึ่งนาที อุปกรณ์เสริมที่ชำรุดเสียหายมักจะแตกออกกระหว่างช่วงเวลาของการทดสอบนี้

### การใช้งาน

#### วิธีการใช้เครื่อง

-  **คำเตือน:** ทำตามคำแนะนำด้านความปลอดภัยและข้อกำหนดที่บังคับใช้เสมอ
-  **คำเตือน:** เพื่อลดความเสี่ยงจากการได้รับบาดเจ็บรุนแรง ต้องปิดเครื่องมือและถอดปลั๊กออกจากแหล่งจ่ายไฟก่อนทำการปรับตั้ง หรือถอด/ติดตั้งอุปกรณ์ยึดติดหรืออุปกรณ์เสริมใดๆ ทุกครั้ง การเผลอเปิดเครื่องโดยไม่ตั้งใจอาจเป็นสาเหตุให้เกิดการบาดเจ็บได้

#### ตำแหน่งการจับที่เหมาะสม (รูป H)

-  **คำเตือน:** เพื่อลดความเสี่ยงจากการได้รับบาดเจ็บสาหัส ให้จับเครื่องมือในตำแหน่งที่ถูกต้องดังแสดงในภาพเสมอ
-  **คำเตือน:** เพื่อลดความเสี่ยงจากการได้รับบาดเจ็บสาหัส ต้องจับเครื่องมือให้แน่นทุกครั้งเพื่อเตรียมพร้อมสำหรับแรงปฏิกิริยาที่เกิดขึ้นแบบทันทีทันใด

การวางตำแหน่งมือที่เหมาะสมคือการวางมือข้างใดข้างหนึ่งไว้บนด้ามจับด้านข้าง 5 และวางมืออีกข้างไว้บนด้ามจับเสริมตามที่แสดงในรูป H

### สวิตช์เลื่อน (รูป A)

-  **ข้อควรระวัง:** จับด้ามจับหลักและตัวเครื่องของเครื่องมือให้แน่นเพื่อคงไว้ซึ่งการควบคุมเครื่องมือเมื่อเริ่มต้นการใช้งานและระหว่างการใช้งานจนกระทั่งใบเจียรหรืออุปกรณ์เสริมหยุดหมุน ตรวจสอบให้แน่ใจว่า ใบเจียรได้หยุดสนิทก่อนที่จะวางเครื่องมือลง

**หมายเหตุ:** ห้ามเปิดเครื่องมือหรือปิดเครื่องมือภายใต้ภาวะไหลตเพื่อลดการเคลื่อนไหวของเครื่องมือที่ไม่คาดคิด ปล่อยให้เครื่องชดทหายทำงานจนถึงความเร็วเต็มอัตรา ก่อนที่จะสัมผัสพื้นผิวของชิ้นงาน ยกเครื่องมือขึ้นจากพื้นผิวก่อนที่จะปิดเครื่องมือ ปล่อยให้เครื่องมือหยุดหมุนก่อนที่จะวางเครื่องมือลง

-  **คำเตือน:** ก่อนที่จะเชื่อมต่อเครื่องมือเข้ากับแหล่งจ่ายไฟ ควรต้องตรวจสอบให้แน่ใจว่า สวิตช์เลื่อนอยู่ในตำแหน่งปิด โดยการกดส่วนหลังของสวิตช์และปล่อยให้ ตรวจสอบให้แน่ใจว่า สวิตช์เลื่อนอยู่ในตำแหน่งปิดตามที่ระบุไว้ในขั้นตอนหลังจากการขัดข้องของเครื่องจ่ายไฟแก่เครื่องมือ เช่น แบตเตอรี่หมด เป็นต้น

เลื่อนสวิตช์เลื่อนเปิด/ปิดเครื่อง 1 ไปที่ด้านหน้าของเครื่องมือเพื่อเริ่มต้นเครื่องมือ และปล่อยให้สวิตช์เลื่อนเปิด/ปิดเครื่องมือเพื่อหยุดเครื่องมือ

สำหรับการใช้งานอย่างต่อเนื่อง ให้คุณเลื่อนสวิตช์ไปที่ด้านหน้าของเครื่องมือ และกดส่วนหน้าของสวิตช์เข้าด้านใน หากต้องการหยุดเครื่องมือในขณะที่กำลังทำงานอย่างต่อเนื่อง ให้คุณกดส่วนหลังของสวิตช์เลื่อนและปล่อยให้

### ที่ล็อคแกนหมุน (รูป I)

ที่ล็อคแกนหมุน 3 ได้รับการจัดหามาให้เพื่อป้องกันไม่ให้แกนหมุนหมุนเมื่อใส่หรือถอดหินเจียร ใช้ที่ล็อคแกนหมุนเฉพาะเมื่อคุณเปิดเครื่องมือ ถอดปลั๊กเครื่องมือออกจากแหล่งจ่ายไฟ และเครื่องมือหยุดสนิทแล้วเท่านั้น

- หมายเหตุ:** ห้ามใช้ที่ล็อคแกนหมุนในขณะที่เครื่องมือกำลังทำงานเพื่อลดความเสี่ยงจากการทำให้เครื่องมือเสียหาย เครื่องมือจะได้รับความเสียหายในขณะที่อุปกรณ์เสริมที่ใส่อาจจะหลุดออกจนทำให้เกิดการบาดเจ็บได้

หากต้องการใช้ที่ล็อค คุณจะต้องกดปุ่มล็อคแกนหมุน และหมุนแกนหมุนให้สุดจนกระทั่งคุณไม่สามารถหมุนแกนหมุนได้อีกต่อไป

### การเจียรพื้นผิว การขัดทราย และการแปรงลวด

-  **ข้อควรระวัง:** ใช้อุปกรณ์ป้องกันที่เหมาะสมตามคำแนะนำที่ระบุไว้ในคู่มือฉบับนี้อยู่เสมอ

ในการทำงานบนพื้นผิวของชิ้นงาน:

1. ปล่อยให้เครื่องมือขึ้นถึงความเร็วเต็มอัตราก่อนที่จะสัมผัสเครื่องมือกับพื้นผิวของชิ้นงาน
2. ใช้แรงกดต่ำสุดกับพื้นผิวของชิ้นงานเพื่อให้เครื่องมือทำงานด้วยความเร็วสูง อัตราการกำจัดวัสดุจะสูงที่สุดเมื่อเครื่องมือทำงานด้วยความเร็วสูง
3. คงไว้ซึ่งมุมที่เหมาะสมระหว่างเครื่องมือกับพื้นผิวของชิ้นงาน ดูที่แผนภาพตามฟังก์ชันแต่ละฟังก์ชัน

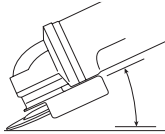

| ฟังก์ชัน                         | มุม     |
|----------------------------------|---------|
| การเจียร                         | 20°-30° |
| การขัดทรายด้วยใบเจียรผ้าทรายข้อน | 5°-10°  |
| การขัดทรายด้วยแผ่นขัด            | 5°-15°  |
| การแปรงลวด                       | 5°-10°  |

4. คงไว้ซึ่งการสัมผัสระหว่างขอบของใบเจียรกับพื้นผิวของชิ้นงาน
  - ขยับเครื่องมืออย่างต่อเนื่องในทิศทางที่ไปข้างหน้าและข้างหลังเมื่อทำการเจียร การขัดทรายด้วยใบเจียรผ้าทรายข้อน หรือการแปรงลวดเพื่อหลีกเลี่ยงการเกิดร่องในพื้นที่ผิวของชิ้นงาน
  - ขยับเครื่องมืออย่างต่อเนื่องเป็นเส้นตรงเพื่อป้องกันการเผาไหม้และการหมุนของพื้นผิวของชิ้นงานเมื่อทำการขัดทรายโดยใช้แผ่นขัด

**หมายเหตุ:** การปล่อยให้เครื่องมือพักบนพื้นผิวของชิ้นงานโดยไม่มีการเคลื่อนไหวจะทำให้ชิ้นงานเสียหาย

5. นำเครื่องมือออกจากพื้นผิวของชิ้นงานก่อนที่จะปิดเครื่องมือ ปล่อยให้เครื่องมือหยุดหมุนก่อนที่จะวางเครื่องมือลง

**!** **ข้อควรระวัง:** ให้การดูแลมากเป็นพิเศษเมื่อทำงานกับขอบเนื่องจากการคุณอาจสัมผัสจากการเคลื่อนไหวที่มีความคมของเครื่องเจียรได้

## ข้อพึงระวังเมื่อทำงานกับชิ้นงานที่ทาสี

1. ไม่แนะนำให้คุณทำการขัดทรายหรือการแปรงลวดสีทาที่มีตะกั่วเป็นส่วนผสมเนื่องจากความยุ่งยากในการควบคุมฝุ่นละอองที่มีการปนเปื้อน ความเป็นพิษของตะกั่วจะเป็นอันตรายมากที่สุดกับเด็กและสตรีมีครรภ์
2. เนื่องจากเป็นเรื่องยากในการระบุว่ามีส่วนผสมของตะกั่วหรือไม่หากไม่ได้ทำการวิเคราะห์ทางเคมี เราจึงแนะนำให้คุณปฏิบัติตามข้อควรระวังดังต่อไปนี้เมื่อทำการขัดทรายสีทาใดก็ตาม:

## ความปลอดภัยส่วนบุคคล

1. เด็กหรือสตรีมีครรภ์จะต่อไม่เข้าไปในพื้นที่ทำงานที่กำลังมีการขัดทรายสีทาหรือการแปรงลวดจนกว่าทุกอย่างจะได้รับการดำเนินการเรียบร้อยแล้ว
2. ทุกคนที่เข้าไปในพื้นที่ทำงานจะต้องใส่หน้ากากป้องกันฝุ่นหรือเครื่องช่วยหายใจ คุณจะต้องเปลี่ยนไส้กรองทุกวันหรือเมื่อใดก็ตามที่ผู้สวมรู้สึกหายใจลำบาก **หมายเหตุ:** คุณจะต้องใช้เฉพาะหน้ากากกันฝุ่นที่เหมาะสมสำหรับการทำงานกับฝุ่นละอองและควั่นจากสีทาที่มีตะกั่วเป็นส่วนผสมเท่านั้น หน้ากากสำหรับการทาสีทั่วไปไม่สามารถช่วยป้องกันในเรื่องนี้ได้ สอบถามตัวแทนจำหน่ายฮาร์ดแวร์ในท้องถิ่นของคุณสำหรับหน้ากาก N.I.O.S.H. ที่เหมาะสมและได้รับการอนุมัติ
3. ห้ามรับประทานอาหาร ดื่มน้ำ หรือสูบบุหรี่ในพื้นที่ทำงานเพื่อป้องกันการรับประทานอนุภาคของสีทาที่ปนเปื้อนเข้าไป ผู้ปฏิบัติงานจะต้องล้างและทำความสะอาดมือและร่างกายก่อนที่จะรับประทานอาหาร ดื่มน้ำ หรือสูบบุหรี่ ผู้ปฏิบัติงานจะต้องไม่รับประทานอาหาร เครื่องดื่ม หรือสูบบุหรี่ในพื้นที่ทำงานเนื่องจากอาจจะมีสัมผัสกับฝุ่นละอองได้

## ความปลอดภัยต่อสิ่งแวดล้อม

1. คุณจะต้องกำจัดสีทาในลักษณะที่เหมาะสมเพื่อลดปริมาณของฝุ่นละอองที่เกิดขึ้น
2. พื้นที่ซึ่งมีการกำจัดสีทาจะต้องได้รับการปิดผนึกด้วยแผ่นพลาสติกซึ่งมีความหนา 4 มิลลิเมตร
3. คุณจะต้องทำการขัดทรายในลักษณะที่เหมาะสมเพื่อลดปริมาณของฝุ่นละอองจากสีทาที่ด้านนอกของพื้นที่ทำงาน

## การทำความสะอาดและการกำจัด

1. พื้นผิวทั้งหมดในพื้นที่ทำงานจะต้องได้รับการดูดฝุ่นและทำความสะอาดทุกวันตลอดระยะเวลาของโครงการขัดทราย ทั้งนี้ คุณจะต้องเปลี่ยนถุงกรองสูญญากาศบ่อยๆ
2. คุณจะต้องเก็บรวบรวมและกำจัดพลาสติกปูพื้นรวมกับเศษฝุ่นหรือเศษที่เหลือจากการกำจัดอื่นๆ ทั้งหมดจะต้องได้รับการใส่ลงในถุงขยะที่ได้รับการปิดผนึกและได้รับการกำจัดตามขั้นตอนการกำจัดขยะตามปกติ เด็กและสตรีมีครรภ์จะต้องออกจากพื้นที่ทำงานทันทีในระหว่างที่มีการทำความสะอาด
3. ของเล่น เครื่องเรือน และเครื่องใช้ทั้งหมดที่เด็กใช้งานซึ่งสามารถซักล้างได้จะต้องได้รับการซักล้างก่อนที่จะนำมาใช้งานอีกครั้ง

## การเจียรและการตัดขอบ

**!** **คำเตือน:** ห้ามใช้หินเจียร/ใบเจียรขอบกับการเจียรพื้นผิวเนื่องจากหินเจียรและใบเจียรดังกล่าวไม่ได้รับการออกแบบมาสำหรับการกดด้านข้างที่พบในการเจียรผิวหน้า และอาจทำให้เกิดการแตกหักของหินเจียรและใบเจียรรวมถึงการบาดเจ็บได้

**!** **ข้อควรระวัง:** หินเจียรและใบเจียรที่ใช้ในการเจียรและการตัดขอบอาจแตกหักหรือสะท้อนกลับได้หาก

หินเจียรและใบเจียรหรือบิต ในขณะที่กำลังใช้ เครื่องมือ ในการเจียร/การตัดขอบทั้งหมด ด้านเปิด ของอุปกรณ์ป้องกันจะต้องได้รับการวางตำแหน่งให้อยู่ไกลออกไปจากผู้ใช้ปฏิบัติงาน

**หมายเหตุ:** การเจียร/การตัดขอบโดยใช้ใบเจียร ประเภท 27 จะต้องถูกจำกัดให้ใช้กับการตัดและการ ทำรอยบากต้นๆ ซึ่งมีความลึกไม่เกิน 13 มม เท่านั้น หากใบเจียรดังกล่าวยังไม่ค่อย ผลิตความลึกของการ ตัด/การทำรอยบากให้เหลือเท่ากับการลดลงของ รัศมีของใบเจียรเนื่องจากใบเจียรจะสึกหรอง ดูที่ **แผนภาพอุปกรณ์เสริม** สำหรับข้อมูลเพิ่มเติม **คุณ** จะต้องใช้อุปกรณ์ป้องกันประเภท 1 สำหรับการเจียร/ การตัดขอบซึ่งใช้ใบเจียรประเภท 41

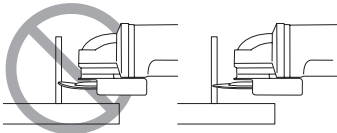

1. ปล่อยให้เครื่องมือขึ้นถึงความเร็วเต็มอัตราก่อนที่จะสัมผัสเครื่องมือลงไปที่พื้นผิวของชิ้นงาน
2. ใช้แรงกดต่ำสุดกับพื้นผิวของชิ้นงานเพื่อให้เครื่องมือทำงานที่ความเร็วสูง อัตราการเจียร/การตัดจะสูงที่สุดเมื่อเครื่องมือทำงานที่ความเร็วสูง
3. วางตำแหน่งตัวคุณเองเพื่อให้ด้านล่างที่เปิดอยู่ของใบเจียรหันห่างออกไปจากตัวคุณ
4. เมื่อเริ่มต้นทำการตัดและสร้างรอยบากในชิ้นงานแล้ว คุณจะต้องไม่เปลี่ยนมุมของการตัด การเปลี่ยนมุมจะทำให้หินเจียรงอ และอาจทำให้หินเจียรแตกหักได้ อนึ่ง หินเจียรขอบไม่ได้รับการออกแบบมาให้ทนทานต่อแรงกดด้านข้างที่เกิดขึ้นจากการงอ
5. นำเครื่องมือออกจากพื้นผิวของชิ้นงานก่อนที่จะปิดเครื่องมือ ปล่อยให้เครื่องมือหยุดหมุนก่อนที่จะวางเครื่องมือลง

### การทำงานกับโลหะ

เมื่อใช้เครื่องมือในการทำงานกับโลหะ คุณจะต้องตรวจสอบให้แน่ใจว่า คุณได้ใช้เครื่องตัดไฟรั่ว (RCD) เพื่อหลีกเลี่ยงความเสี่ยงของความเสี่ยงซึ่งเกิดจากเศษโลหะ

หากแหล่งจ่ายไฟถูกตัดโดย RCD คุณจะต้องนำเครื่องมือไปหาตัวแทนซ่อมของ DEWALT ที่ได้รับการอนุญาต

**!** **คำเตือน:** ในสภาวะการทำงานที่ย่ำแย่ อาจเกิดการสะสมของฝุ่นไวไฟที่ติดในของตัวเรือนเครื่องมือเมื่อทำงานกับโลหะ เรื่องดังกล่าวจะส่งผลให้ฉนวนป้องกันในเครื่องมือสึกหรอ รวมถึงจะทำให้เกิดความเสี่ยงจากไฟฟ้าดูดได้

เพื่อหลีกเลี่ยงการสะสมของเศษโลหะที่ด้านในของเครื่องมือ เราจึงขอแนะนำให้คุณทำความสะอาดช่องระบายอากาศทุกวัน ดูที่ **การบำรุงรักษา**

### การตัดโลหะ

**สำหรับการตัดสารกัดกร่อน คุณจะต้องใช้อุปกรณ์ป้องกันประเภท 1 อยู่เสมอ**

เมื่อทำการตัด คุณจะต้องทำงานกับการป้อนในระดับปานกลางซึ่งได้รับการปรับตามวัสดุที่จะทำการตัด ห้ามใช้แรงที่มากเกินไปกับใบตัด หรือเอียงหรือส่ายเครื่องมือ ห้ามลดความเร็วของใบตัดโดยการใช้แรงกดที่ด้านข้าง เครื่องมือจะต้องทำงานในการเคลื่อนไหวแบบเจียรขึ้นอยู่เสมอ มิเช่นนั้น อาจจะทำให้เกิดอันตรายเมื่อไม่สามารถควบคุมการตัดได้

เมื่อทำการตัดโครงร่างและแท่งสี่เหลี่ยม ทางที่ดีที่สุดคุณควรจะเริ่มต้นที่หน้าตัดที่มีขนาดเล็กที่สุดก่อน

### การเจียรหยาบ

**ห้ามใช้ใบตัดสำหรับการเจียรหยาบโดยเด็ดขาด ใช้ อุปกรณ์ป้องกันประเภท 27 อยู่เสมอ**

ผลลัพธ์ของการเจียรหยาบที่ดีที่สุดจะได้มาเมื่อคุณตั้งเครื่องมือที่มุมระหว่าง 30 องศาถึง 40 องศา ขยับเครื่องมือไปด้านหลังและด้านหน้าโดยใช้แรงกดปานกลาง การเคลื่อนไหวในลักษณะนี้จะทำให้ชิ้นงานไม่ร้อนจัดเกินไป ไม่ทำให้สีเปลี่ยน และไม่ทำให้เกิดร่อง

### การตัดหิน

**คุณจะต้องใช้เครื่องมือในการตัดแบบแห้งเท่านั้น**

ในส่วนของ การตัดหิน ทางที่ดีที่สุดคุณควรจะใช้ใบตัดเพชร และใช้งานเครื่องมือเมื่อคุณใส่หน้ากากป้องกันฝุ่นละอองเพิ่มเติมเท่านั้น

### คำแนะนำในการทำงาน

**ปฏิบัติงานด้วยความระมัดระวังเมื่อทำการตัดช่องในผนังเชิงโครงสร้าง**

ช่องในผนังเชิงโครงสร้างจะต้องเป็นไปตามกฎข้อบังคับตามที่ระบุไว้ของแต่ละประเทศ คุณจะต้องปฏิบัติตามกฎข้อบังคับดังกล่าวในทุกกรณี ทั้งนี้ ก่อนที่จะเริ่มต้นการทำงาน คุณจะต้องปรึกษากับวิศวกรโครงสร้าง สถาปนิก หรือผู้ควบคุมงานก่อสร้างที่มีหน้าที่รับผิดชอบก่อน

### การบำรุงรักษา

เครื่องมือไฟฟ้า ออกแบบมาเพื่อให้อาจใช้งานได้ยาวนานโดยมีการบำรุงรักษาน้อยที่สุด การทำงานที่สร้างความพึงพอใจอย่างต่อเนื่องจะขึ้นอยู่กับ การดูแลรักษาที่เหมาะสมและการทำความสะอาดอย่างสม่ำเสมอ

**!** **คำเตือน:** เพื่อลดความเสี่ยงจากการได้รับบาดเจ็บรุนแรง ต้องปิดเครื่องมือและถอดปลั๊กออกจากแหล่งจ่ายไฟก่อนทำการปรับตั้ง หรือถอด/ติดตั้งอุปกรณ์ยึดติดหรืออุปกรณ์เสริมใดๆ ทุกครั้ง การปลดเปิดเครื่องโดยไม่ไต่ตั้งใจอาจเป็นสาเหตุให้เกิดการบาดเจ็บได้

เครื่องชาร์จและชุดแบตเตอรี่ไม่สามารถซ่อมแซมได้



## การหล่อลื่น

ไม่จำเป็นต้องใช้การหล่อลื่นเพิ่มเติมกับเครื่องมือไฟฟ้านี้



## การทำความสะอาด



**คำเตือน:** หมั่นเป่าสิ่งสกปรกและฝุ่นละอองที่สะสมออกจากตัวเครื่องเป็นประจำด้วยลมแห้ง เนื่องจากสิ่งสกปรกมักสะสมอยู่ภายในและรอบๆ ช่องระบายอากาศ สวมอุปกรณ์ป้องกันดวงตาและหน้ากากกันฝุ่นที่ได้มาตรฐานในขณะที่ดำเนินการขั้นตอนนี้



**คำเตือน:** ห้ามใช้สารที่เป็นตัวทำละลายหรือสารเคมีที่มีฤทธิ์กัดกร่อนรุนแรงอื่นๆ ทำความสะอาดชิ้นส่วนที่ไม่ใช่โลหะของเครื่องมือ สารเคมีเหล่านี้อาจส่งผลต่อวัสดุที่ใช้ในชิ้นส่วนเหล่านี้ ใช้เฉพาะผ้าขุบน้ำสบู่อ่อนๆ เท่านั้น อย่าให้มีของเหลวใดๆ เข้าไปในเครื่องมือเด็ดขาด ห้ามจุ่มส่วนใดๆ ของเครื่องมือลงในของเหลวเด็ดขาด

## อุปกรณ์เสริม



**คำเตือน:** เนื่องจากอุปกรณ์เสริมอื่นนอกเหนือจากที่ DEWALT มีจำหน่ายไม่ได้ผ่านการทดสอบร่วมกับผลิตภัณฑ์นี้ จึงอาจเป็นอันตรายหากใช้อุปกรณ์เสริมดังกล่าวร่วมกับเครื่องมือนี้ เพื่อเป็นการลดความเสี่ยงจากการได้รับบาดเจ็บ ให้ใช้อุปกรณ์เสริมเฉพาะที่ DEWALT แนะนำให้ใช้ร่วมกับผลิตภัณฑ์เท่านั้น

โปรดติดต่อตัวแทนจำหน่ายหากต้องการข้อมูลเพิ่มเติมเกี่ยวกับอุปกรณ์เสริมที่เหมาะสม

## การปกป้องสิ่งแวดล้อม



การเก็บรวบรวมแบบคัดแยก ห้ามทิ้งผลิตภัณฑ์และแบตเตอรี่ที่มีสัญลักษณ์นี้รวมกับขยะในครัวเรือนปกติ

ผลิตภัณฑ์และแบตเตอรี่ประกอบด้วยวัสดุที่สามารถ

นำกลับมาใช้ใหม่หรือรีไซเคิลได้เพื่อลดความต้องการวัตถุดิบ โปรดรีไซเคิลอุปกรณ์ไฟฟ้าและแบตเตอรี่ตามข้อบังคับในท้องถิ่น ดูข้อมูลเพิ่มเติมได้ที่ [www.2helpU.com](http://www.2helpU.com)

## ชุดแบตเตอรี่แบบชาร์จซ้ำได้

แบตเตอรี่ที่มีอายุการใช้งานยาวนานนี้จำเป็นต้องรับการชาร์จไฟใหม่เมื่อไม่สามารถจ่ายพลังงานเพียงพอสำหรับการทำงานซึ่งเคยทำได้โดยง่าย เมื่อแบตเตอรี่หมดอายุการทำงานทางด้านเทคนิคแล้ว ให้นำแบตเตอรี่ไปกำจัดทิ้งโดยคำนึงถึงผลกระทบต่อสิ่งแวดล้อม:











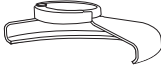

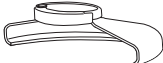
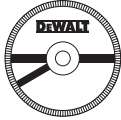

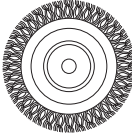
- ใช้แบตเตอรี่ให้หมดเกลี้ยง จากนั้นถอดแบตเตอรี่ออกจากเครื่องมือ

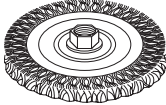
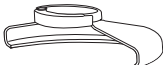
- แบตเตอรี่ลิเทียมไอออนสามารถรีไซเคิลได้ โปรดนำไปที่ตัวแทนจำหน่ายหรือสถานีรีไซเคิลในพื้นที่ของคุณ ชุดแบตเตอรี่ที่เรารวบรวมไว้จะนำไปรีไซเคิลหรือกำจัดอย่างเหมาะสมต่อไป

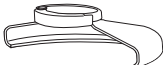

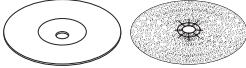
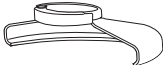



## บริการหลังการขายและการซ่อมแซมผลิตภัณฑ์

ศูนย์บริการ DEWALT ของเราประกอบไปด้วยบุคลากรที่ได้รับการฝึกอบรมมาเป็นอย่างดีในการให้บริการผลิตภัณฑ์ที่มีประสิทธิภาพและไว้วางใจได้แก่ลูกค้า อย่างไรก็ตาม เราจะไม่รับผิดชอบใดๆ หากคุณซ่อมแซมผลิตภัณฑ์กับศูนย์บริการที่ไม่ได้รับการอนุญาตจากเรา คุณสามารถดูที่ตั้งของศูนย์ติดต่อได้จากแผ่นพับในบรรจุภัณฑ์ของผลิตภัณฑ์และติดต่อเราได้ผ่านสายด่วน เว็บไซต์หรือโซเชียลมีเดียเพื่อค้นหาศูนย์บริการ DEWALT ซึ่งอยู่ใกล้คุณมากที่สุด

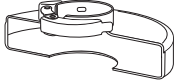
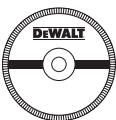
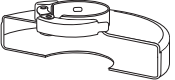
## แผนภาพอุปกรณ์เสริม

| ประเภทของอุปกรณ์ป้องกัน   | อุปกรณ์เสริม  | คำอธิบาย               | วิธีการใส่เครื่องเจียร  |
|---|---|------------------------|---|
| <br>อุปกรณ์ป้องกันประเภท 27 |    | แผ่นเจียรแบบกดตรงกลาง  | <br>อุปกรณ์ป้องกันประเภท 27  |
|   |    | ล้อขีด                 | <br>หน้าแปลนเหล็ก  |
|   |    | ล้อลวด                 | <br>เจียรแบบกดตรงกลางประเภท 27<br><br>หน้าแปลนล้อด  |
|   |    | ล้อลวดพร้อมน็อตเกลียว  | <br>อุปกรณ์ป้องกันประเภท 27<br><br>แปรงลวดกลม   |
|   |   | ถ้วยลวดพร้อมน็อตเกลียว | <br>อุปกรณ์ป้องกันประเภท 27<br><br>แปรงลวด  |
|   |  | แผ่นขีด / แผ่นขีดทราย  | <br>อุปกรณ์ป้องกันประเภท 27<br><br>แผ่นขีดยาง<br><br>แผ่นขีดทราย<br><br>น็อตยึด |

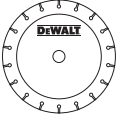
## แผนภาพอุปกรณ์เสริม (ต่อ)

| ประเภทของอุปกรณ์ป้องกัน  | อุปกรณ์เสริม  | คำอธิบาย              | วิธีการใส่เครื่องเจียร  |
|--|---|-----------------------|---|
| <br>อุปกรณ์ป้องกันประเภท 1   |  | แผ่นตัดอัญมณี, ยึดไว้ | <br>อุปกรณ์ป้องกันประเภท 1   |
|  |  | แผ่นตัดโลหะ, ยึดไว้   | <br>หน้าแปลนหลัก   |
| <br>OR อุปกรณ์เสริมประเภท 1<br><br>อุปกรณ์ป้องกันประเภท 27 |  | ใบตัดเพชร             | <br>ใบตัด<br><br>หน้าแปลนลิ้น |

# MÁY MÀI PIN CÔNG TẮC TRƯỢT

## DCG409

### Xin chúc mừng!

Bạn đã chọn thiết bị của DEWALT. Qua nhiều năm kinh nghiệm, những đổi mới và phát triển sản phẩm một cách toàn diện đã giúp DEWALT trở thành một trong những đối tác đáng tin cậy nhất đối với người sử dụng dụng cụ điện cầm tay chuyên nghiệp.

### Thông số kỹ thuật

|                               |                   | DCG409-TW   | DCG409-B1   | DCG409-KR   | DCG409NT-A9 |
|-------------------------------|-------------------|-------------|-------------|-------------|-------------|
| Điện áp                       | V <sub>DC</sub>   | 18 (20 Max) | 18 (20 Max) | 18 (20 Max) | 18 (20 Max) |
| Loại pin                      |                   | Li-Ion      | Li-Ion      | Li-Ion      | Li-Ion      |
| Công Suất Đầu Ra              | W                 | 1647        | 1647        | 1647        | 1647        |
| Tối Đa                        |                   |             |             |             |             |
| Tốc độ định mức               | min <sup>-1</sup> | 9000        | 9000        | 9000        | 9000        |
| Đường kính đĩa mài            | mm                | 125         | 100         | 125         | 125         |
| Độ dày bánh xe (tối đa)       | mm                | 6           | 4           | 6           | 6           |
| Đường kính trục chính         |                   | M14         | M10         | M10         | M14         |
| Chiều dài trục chính          | mm                | 21.5        | 16          | 16          | 21.5        |
| Trọng lượng (không có bộ pin) | kg                | 1.81        | 1.62        | 1.73        | 1.81        |

Mức rung được cung cấp trong bảng thông tin này được đo theo một thử nghiệm đã được tiêu chuẩn hóa trong EN60745 và có thể được sử dụng để so sánh hai dụng cụ với nhau. Có thể sử dụng mức rung này để đánh giá sơ bộ về độ rung của máy.

**!** **CẢNH BÁO:** Mức rung thiết kế được tạo ra khi thực hiện các chức năng chính của dụng cụ. Tuy nhiên, nếu bạn sử dụng dụng cụ cho các mục đích khác, với những phụ kiện khác hoặc công tác bảo trì dụng cụ kém, độ rung có thể thay đổi. Điều này có thể làm tăng đáng kể mức độ rung của máy trong toàn bộ quá trình làm việc.

Cũng nên tính toán thời gian dụng cụ tắt hoặc khi dụng cụ đang chạy nhưng không thực hiện công việc để ước tính mức độ gia tăng rung động của máy. Điều này có thể giúp giảm đáng kể độ rung của máy trong toàn bộ thời gian làm việc.

Tìm ra các biện pháp an toàn bổ sung để bảo vệ người vận hành khỏi những ảnh hưởng của rung động như bảo trì dụng cụ và phụ kiện, giữ ẩm tay, sắp xếp các mẫu làm việc.



**CẢNH BÁO:** Để giảm nguy cơ chấn thương, hãy đọc hướng dẫn sử dụng này.

### Định nghĩa: Hướng dẫn an toàn

Các định nghĩa dưới đây mô tả mức độ nghiêm trọng của từng từ ký hiệu. Vui lòng đọc sổ hướng dẫn sử dụng và chú ý đến các biểu tượng này.



**NGUY HIỂM:** Chỉ tình huống nguy hiểm sắp xảy ra sẽ gây tử vong hoặc chấn thương nghiêm trọng nếu không phòng tránh.



**CẢNH BÁO:** Chỉ tình huống nguy hiểm tiềm ẩn có thể gây tử vong hoặc chấn thương nghiêm trọng nếu không phòng tránh.



**THẬN TRỌNG:** Chỉ tình huống nguy hiểm tiềm ẩn, nếu không phòng tránh, có thể gây chấn thương nhẹ hoặc vừa.

**LƯU Ý:** Chỉ một hành động không liên quan đến chấn thương cá nhân nếu không phòng tránh, có thể gây hư hỏng tài sản.



Biểu thị nguy cơ bị điện giật.



Biểu thị nguy cơ hỏa hoạn.

| Pin           |                   |          |                 | Bộ sạc / Thời gian sạc (Phút) |        |        |        |         |         |        |         |
|---------------|-------------------|----------|-----------------|-------------------------------|--------|--------|--------|---------|---------|--------|---------|
| Cat#          | V <sub>DC</sub>   | Ah       | Trọng lượng(kg) | DCB104                        | DCB107 | DCB112 | DCB115 | DCB117  | DCB118  | DCB132 | DCB112  |
| DCB546/DCB606 | 18/54 (20/60 Max) | 6.0/2.0  | 1.05            | 60                            | 270    | 170    | 90     | 40      | 60      | 90     | 40      |
| DCB547/DCB609 | 18/54 (20/60 Max) | 9.0/3.0  | 1.46            | 75*                           | 420    | 270    | 135*   | 60      | 75*     | 135*   | 60      |
| DCB548/DCB612 | 18/54 (20/60 Max) | 12.0/4.0 | 1.44            | 120                           | 540    | 350    | 180    | 80      | 120     | 180    | 80      |
| DCB181        | 18 (20 Max)       | 1.5      | 0.35            | 22                            | 70     | 45     | 22     | 22      | 22      | 22     | 22      |
| DCB182/DCB204 | 18 (20 Max)       | 4.0      | 0.61            | 60/40**                       | 185    | 120    | 60     | 60/40** | 60/40** | 60     | 60/40** |
| DCB183/DCB203 | 18 (20 Max)       | 2.0      | 0.40            | 30                            | 90     | 60     | 30     | 30      | 30      | 30     | 30      |
| DCB184/DCB205 | 18 (20 Max)       | 5.0      | 0.62            | 75/50**                       | 240    | 150    | 75     | 75/50** | 75/50** | 75     | 75/50** |
| DCB185        | 18 (20 Max)       | 1.3      | 0.35            | 22                            | 60     | 40     | 22     | 22      | 22      | 22     | 22      |
| DCB187        | 18 (20 Max)       | 3.0      | 0.54            | 45                            | 140    | 90     | 45     | 45      | 45      | 45     | 45      |
| DCB189/DCB240 | 18 (20 Max)       | 4.0      | 0.54            | 60                            | 185    | 120    | 60     | 60      | 60      | 60     | 60      |
| DCB186        | 18 (20 Max)       | 6.0      | 0.95            | 60                            | 270    | 170    | 90     | 60      | 60      | 90     | 60      |

\*Mã ngày 201811475B hoặc muộn lên

\*\*Mã ngày 201536 hoặc muộn lên



## Cảnh báo chung về an toàn cho máy điện cầm tay



**CẢNH BÁO:** Đọc kỹ mọi cảnh báo an toàn, hướng dẫn, minh họa và thông số kỹ thuật đi kèm theo máy điện cầm tay này. Việc không tuân theo tất cả các hướng dẫn được liệt kê bên dưới có thể dẫn đến điện giật, cháy và/hoặc chấn thương nghiêm trọng.

### LƯU GIỮ MỌI CẢNH BÁO VÀ HƯỚNG DẪN ĐỂ THAM KHẢO SAU NÀY

Thuật ngữ “máy điện cầm tay” trong phần cảnh báo chỉ thiết bị chạy bằng điện nguồn (có dây điện) hoặc thiết bị chạy bằng pin (không có dây điện).

#### 1) An toàn tại nơi làm việc

- Khu vực làm việc phải sạch sẽ và đủ ánh sáng.** Những khu vực bừa bộn hoặc thiếu ánh sáng dễ gây tai nạn.
- Không vận hành máy điện cầm tay trong các môi trường dễ cháy nổ, như các môi trường có chất lỏng, khí hoặc bụi dễ cháy.** Máy điện cầm tay tạo ra các tia lửa điện có thể gây cháy bụi hoặc bốc khói.
- Không cho trẻ em và những người quan sát lại gần khi đang vận hành máy điện cầm tay.** Những lúc xao lãng có thể khiến bạn mất kiểm soát.

#### 2) An toàn điện

- Phích cắm của máy điện cầm tay phải vừa với ổ cắm. Không được sửa đổi phích cắm dưới bất kỳ hình thức nào. Không sử dụng các loại phích cắm nối cho máy điện cầm tay có nối đất.** Phích cắm nguyên trạng và ổ cắm phù hợp sẽ giúp giảm nguy cơ bị điện giật.
- Tránh tiếp xúc với các bề mặt được nối đất như đường ống, lò sưởi, bếp nướng và tủ lạnh.** Nguy cơ bị điện giật sẽ cao hơn nếu có thể bạn nối đất.
- Không để các máy điện cầm tay ngoài trời mưa hoặc ở nơi ẩm ướt.** Nước vào trong máy điện cầm tay sẽ làm tăng nguy cơ bị điện giật.
- Không dùng dây điện cho các mục đích khác. Tuyệt đối không sử dụng dây điện để mang, kéo hoặc rút phích cắm máy điện cầm tay. Để dây điện cách xa nguồn nhiệt, dầu mỡ, các cạnh sắc hoặc các bộ phận chuyển động.** Dây điện bị hỏng hoặc bị vướng sẽ làm tăng nguy cơ bị điện giật.
- Khi vận hành máy điện cầm tay ngoài trời, hãy sử dụng dây nối dài phù hợp để sử dụng ngoài trời.** Sử dụng dây điện phù hợp để sử dụng ngoài trời sẽ giúp giảm nguy cơ bị điện giật.
- Nếu bắt buộc phải vận hành máy điện cầm tay ở nơi ẩm ướt, hãy sử dụng nguồn điện được bảo vệ bởi thiết bị ngắt mạch tự động (RCD).** Sử dụng RCD giúp giảm nguy cơ bị điện giật.

#### 3) An toàn cá nhân

- Hãy tập trung, chú ý vào những gì bạn đang làm và tỉnh táo khi vận hành máy điện cầm tay. Không sử dụng máy điện cầm tay khi bạn đang mệt hoặc**

**chịu ảnh hưởng của rượu bia, ma túy hoặc chất kích thích.** Chỉ một khoảng khắc mất tập trung trong khi vận hành máy điện cầm tay cũng có thể dẫn đến chấn thương cá nhân nghiêm trọng.

- Sử dụng thiết bị bảo hộ cá nhân. Luôn đeo kính bảo hộ.** Thiết bị bảo hộ như mặt nạ chống bụi, giày chống trượt, mũ cứng hoặc thiết bị bảo vệ tai, được sử dụng ở những điều kiện phù hợp, sẽ giúp giảm các chấn thương cá nhân.
  - Tránh vô tình bật máy. Đảm bảo rằng công tắc ở vị trí tắt trước khi nối với nguồn điện và/hoặc pin, khi cầm hoặc mang máy.** Việc cầm máy điện cầm tay khi ngón tay đặt vào công tắc hoặc sạc pin cho máy điện cầm tay khi công tắc đang bật có thể gây tai nạn.
  - Hãy tháo hết khóa điều chỉnh hoặc cờ lê trước khi bật máy điện cầm tay.** Cờ lê hoặc khóa vẫn để ở bộ phận quay của máy điện cầm tay có thể dẫn đến chấn thương cá nhân.
  - Không được vớ tay. Hãy đứng ở tư thế thích hợp và luôn giữ thăng bằng.** Điều đó giúp kiểm soát máy điện cầm tay tốt hơn trong các tình huống bất ngờ.
  - Mặc quần áo phù hợp. Không mặc quần áo rộng hoặc đeo đồ trang sức. Giữ cho tóc và quần áo tránh xa các bộ phận di động.** Quần áo rộng, đồ trang sức hoặc tóc dài có thể bị mắc vào các bộ phận di động.
  - Nếu cần thiết bị được cung cấp để nối các phương tiện hút và gom bụi, hãy đảm bảo những thiết bị này được nối và sử dụng đúng cách.** Sử dụng thiết bị gom bụi có thể giảm các nguy cơ liên quan đến bụi.
  - Không nên tự mãn vì đã dùng thành thạo máy mà bỏ qua các nguyên tắc an toàn của máy.** Một hành động bất cẩn cũng có thể gây ra thương tích nghiêm trọng trong tích tắc.
- #### 4) Sử dụng và bảo quản máy điện cầm tay
- Sử dụng máy điện cầm tay phù hợp. Sử dụng máy điện cầm tay phù hợp với mục đích của bạn.** Máy phù hợp sẽ giúp bạn làm việc hiệu quả và an toàn hơn theo đúng tốc độ được thiết kế.
  - Không sử dụng máy điện cầm tay nếu công tắc không bật và tắt được.** Những máy điện cầm tay không điều khiển được bằng công tắc đều rất nguy hiểm và cần phải được sửa chữa.
  - Rút phích cắm khỏi nguồn điện và/hoặc tháo pin ra nếu có thể tháo rời khỏi máy điện cầm tay, trước khi thực hiện các điều chỉnh, thay đổi phụ kiện hoặc cắt giũa máy điện cầm tay.** Các biện pháp an toàn phòng ngừa đó giúp giảm nguy cơ khởi động máy điện cầm tay một cách tình cờ.
  - Bảo quản các máy điện cầm tay không sử dụng xa tầm tay trẻ em và không cho phép những người không quen với máy điện cầm tay hoặc những hướng dẫn này vận hành máy điện cầm tay.** Máy điện cầm tay sẽ rất nguy hiểm khi được sử dụng bởi những người chưa được huấn luyện.
  - Bảo trì các phụ kiện và máy điện cầm tay. Kiểm tra các bộ phận chuyển động xem có bị lắp lệch hoặc**

*kẹt không, các bộ phận có bị vỡ không và bất kỳ tình trạng nào khác có thể ảnh hưởng đến việc vận hành máy điện cầm tay. Nếu máy điện cầm tay bị hỏng, hãy sửa chữa trước khi sử dụng. Rất nhiều tai nạn xảy ra do công tác bảo trì các máy điện cầm tay kém.*

- f) **Đảm bảo các thiết bị cắt luôn sắc và sạch sẽ.** Các dụng cụ cắt được bảo trì đúng cách với các cạnh cắt sắc sẽ ít bị kẹt hơn và dễ điều khiển hơn.
- g) **Sử dụng máy điện cầm tay, các phụ kiện và mũi khoan, v.v.. theo hướng dẫn này, chú ý đến các điều kiện làm việc và công việc cần thực hiện.** Sử dụng máy điện cầm tay sai mục đích có thể gây nguy hiểm.
- h) **Giữ các tay cầm và bề mặt cầm nắm luôn khô ráo, sạch sẽ và không dính dầu mỡ.** Các tay cầm và bề mặt cầm nắm trơn trượt không cho phép xử lý và kiểm soát máy an toàn trong những tình huống bất ngờ.

## 5) Sử dụng và bảo quản máy chạy bằng pin

- a) **Chỉ sạc lại pin bằng bộ sạc do nhà sản xuất quy định.** Bộ sạc chỉ thích hợp cho một loại pin. Nếu sử dụng với loại pin khác, có thể tạo nguy cơ hỏa hoạn.
- b) **Chỉ sử dụng máy điện cầm tay với các loại pin được chỉ định cụ thể.** Sử dụng loại pin khác có thể tạo nguy cơ bị chấn thương và hỏa hoạn.
- c) **Khi không sử dụng pin, để pin tránh xa các vật dụng kim loại như kẹp giấy, tiền đồng, chìa khóa, đinh, vít, hay các vật dụng kim loại nhỏ khác có thể tạo kết nối từ cực này sang cực khác.** Khi các cực của pin tiếp xúc với nhau có thể gây bỏng hoặc hỏa hoạn.
- d) **Nếu làm dụng pin, dung dịch có thể chảy ra từ pin; tránh tiếp xúc.** Nếu vô tình tiếp xúc, hãy rửa bằng nước. Nếu chất lỏng dính vào mắt, hãy điều trị y tế ngay. Chất lỏng chảy ra từ pin có thể gây kích ứng hoặc bỏng da.
- e) **Không sử dụng pin hoặc máy khi bị hỏng hoặc đã bị chỉnh sửa.** Pin hỏng hoặc đã bị chỉnh sửa có thể gây ra những phản ứng khó lường, dẫn đến cháy nổ hoặc có nguy cơ gây chấn thương.
- f) **Không để pin hoặc máy gần khu vực có lửa hoặc nhiệt độ quá cao.** Tiếp xúc với lửa hoặc nhiệt độ trên 130 °C có thể gây nổ.
- g) **Tuân theo mọi hướng dẫn về sạc pin và không được sạc máy quá phạm vi nhiệt độ được ghi trong hướng dẫn.** Sạc pin không đúng cách hoặc ở các mức nhiệt độ nằm ngoài phạm vi chỉ định có thể làm hỏng pin và tăng nguy cơ hỏa hoạn.

## 6) Bảo dưỡng

- a) **Hãy để nhân viên bảo dưỡng có chuyên môn tiến hành bảo dưỡng máy điện cầm tay cho bạn và chỉ sử dụng các bộ phận thay thế chính hãng.** Điều này giúp đảm bảo độ an toàn của máy điện cầm tay đó.
- b) **Tuyệt đối không bảo dưỡng pin đã hỏng.** Việc bảo dưỡng pin phải được thực hiện bởi nhà sản xuất hoặc nhà cung cấp dịch vụ bảo dưỡng được ủy quyền.

# CÁC QUY TẮC AN TOÀN CỤ THỂ BỔ SUNG

## Hướng dẫn an toàn cho mọi hoạt động

- a) **Dụng cụ điện cầm tay này được thiết kế để hoạt động như máy mài. Đọc kỹ mọi cảnh báo an toàn, hướng dẫn, minh họa và thông số kỹ thuật đi kèm theo máy.** Việc không tuân theo tất cả các hướng dẫn được liệt kê bên dưới có thể dẫn đến điện giật, cháy và/hoặc chấn thương nghiêm trọng.
- b) **Không nên dùng dụng cụ điện cầm tay này để chà nhám, chà ri, đánh bóng hoặc cắt rời.** Các công việc không phù hợp với thiết kế của máy điện cầm tay này có thể gây nguy hiểm và chấn thương cá nhân.
- c) **Không sử dụng các phụ kiện không được thiết kế chuyên biệt và không được nhà sản xuất dụng cụ khuyến dùng.** Mặc dù có thể gắn phụ kiện vào dụng cụ điện cầm tay của bạn, nhưng điều đó không đảm bảo nó sẽ vận hành an toàn.
- d) **Tốc độ định mức của phụ kiện tối thiểu phải bằng với tốc độ tối đa được ghi trên dụng cụ điện cầm tay.** Các phụ kiện chạy nhanh hơn tốc độ định mức của chúng có thể vỡ và văng ra xa.
- e) **Đường kính ngoài và độ dày của phụ kiện phải nằm trong định mức kích cỡ của máy điện cầm tay.** Các phụ kiện có kích cỡ không phù hợp sẽ không được bảo vệ hoặc kiểm soát thích đáng.
- f) **Việc gắn ren các phụ kiện phải khớp với ren của trục chính máy mài. Đối với các phụ kiện gắn bằng mặt bích, lỗ tâm của phụ kiện phải vừa với đường kính định vị của mặt bích.** Các phụ kiện không khớp với vòng gá của dụng cụ điện cầm tay sẽ gây mất cân bằng, rung quá mức và có thể gây mất kiểm soát.
- g) **Không sử dụng phụ kiện bị hỏng. Trước khi dùng phải kiểm tra phụ kiện như đĩa mài có bị mòn không, có bị nứt, có mặt không, bạc lót có bị nứt, rách hoặc mòn quá không, chổi kim loại có bị lỏng hay dây có bị gãy không. Nếu để rơi máy điện cầm tay, phải kiểm tra xem máy có bị hỏng không và lắp lại phần phụ kiện chưa bị hỏng. Sau khi kiểm tra và lắp phụ kiện, bạn và những người quan sát nên đứng tránh xa mặt phẳng quay của phụ kiện và chạy máy điện cầm tay ở tốc độ không tải tối đa trong một phút.** Các phụ kiện bị hỏng thường sẽ vỡ thành từng mảnh trong thời gian chạy thử này.
- h) **Đeo thiết bị bảo hộ cá nhân. Tùy thuộc vào mục đích sử dụng, có thể dùng tấm che mặt, kính bảo hộ hoặc kính an toàn. Nếu có thể, đeo mặt nạ chống bụi, dụng cụ bảo vệ tai, găng tay và tạp dề công nhân có khả năng cản các mảnh vỡ của phối gia công hoặc mảnh vụn mài nhỏ. Kính bảo hộ phải có khả năng cản các mảnh vụn văng ra được tạo ra từ nhiều thao tác khác nhau. Mặt nạ chống bụi hoặc khẩu trang phải có khả năng lọc các hạt sinh ra**

**trong quá trình vận hành.** Tiếp xúc với tiếng ồn cường độ cao trong thời gian dài có thể gây giảm thính lực.

- i) **Đảm bảo những người quan sát luôn cách khu vực làm việc một khoảng cách an toàn. Mọi người đi vào khu vực làm việc đều phải đeo thiết bị bảo hộ cá nhân.** Các mảnh vụn phôi gia công hoặc phụ kiện vỡ có thể văng ra và gây chấn thương ngay trong khu vực vận hành.
- j) **Chỉ cầm dụng cụ điện cầm tay ở phần bề mặt tay cầm cách điện khi thực hiện thao tác mà phụ kiện cắt có thể tiếp xúc với hệ thống dây điện chìm hoặc dây điện của chính dụng cụ.** Phụ kiện cắt tiếp xúc với dây điện "có điện" có thể truyền điện cho các bộ phận kim loại hở của dụng cụ điện cầm tay và có thể khiến người vận hành bị điện giật.
- k) **Tuyệt đối không đặt dụng cụ điện cầm tay xuống khi phụ kiện chưa dừng hẳn.** Phụ kiện quay có thể găm vào bề mặt và kéo máy điện cầm tay ra khỏi tầm kiểm soát của bạn.
- l) **Không cầm dụng cụ điện cầm tay ở sát người khi vận hành dụng cụ điện cầm tay.** Vô tình tiếp xúc với phụ kiện đang quay có thể làm quần áo bị vướng vào, kéo phụ kiện vào người.
- m) **Thường xuyên vệ sinh các lỗ thông khí của máy điện cầm tay.** Quạt của động cơ sẽ hút bụi bên trong vỏ máy và để bột kim loại tích lũy quá nhiều có thể gây ra nguy hiểm về điện.
- n) **Không vận hành công cụ điện gần các vật liệu dễ cháy.** Tia lửa có thể làm các vật liệu này bốc cháy.
- o) **Không sử dụng các phụ kiện cần có chất làm mát dạng lỏng.** Sử dụng nước hoặc chất làm mát dạng lỏng khác có thể dẫn đến bị điện giật.
- p) **Không sử dụng bánh xe Loại 1 (cốc gương) trên công cụ này.** Sử dụng các phụ kiện không phù hợp có thể dẫn đến chấn thương.
- q) **Luôn luôn sử dụng tay cầm bên sườn. Thất chặt tay cầm an toàn.** Tay cầm bên sườn luôn luôn được sử dụng để duy trì kiểm soát công cụ mọi lúc.



**CẢNH BÁO:** Chúng tôi khuyến nghị sử dụng thiết bị dòng dư có định mức dòng dư từ 30mA trở xuống.

## CHỈ DẪN AN TOÀN BỔ SUNG CHO MỌI HOẠT ĐỘNG

### Nguyên nhân và cách phòng tránh hiện tượng người vận hành bị giật lại

Lực giật lại là phản lực bất ngờ của đĩa mài, bạc lót, chổi than hoặc bất kỳ phụ kiện đang quay nào khác bị kẹt hoặc bị vướng. Khi bị vướng hoặc kẹt, phụ kiện đang quay sẽ dừng lại nhanh chóng khiến cho người vận hành bị mất kiểm soát và máy điện cầm tay bị đẩy theo chiều ngược lại với chiều quay của phụ kiện tại điểm kẹt.

Ví dụ: nếu đĩa mài bị vướng hoặc kẹt vào phôi gia công, cạnh của đĩa mài đang tiến vào điểm kẹt có thể cắm sâu vào bề mặt của vật liệu khiến cho đĩa mài lên hoặc văng ra. Đĩa mài có thể văng về phía người vận hành hoặc văng ra ngoài, tùy thuộc vào chiều chuyển động của đĩa mài tại thời điểm bị kẹt. Đĩa mài cũng có thể vỡ ra trong điều kiện này.

Lực giật lại là hậu quả của việc dùng máy không đúng cách và/hoặc quy trình vận hành không chính xác hoặc các điều kiện khác và có thể phòng tránh được bằng cách thực hiện các biện pháp phòng ngừa phù hợp như sau:

- a) **Cầm chắc máy điện cầm tay đồng thời định vị người và tay để bạn có thể cầm được lực giật lại. Luôn sử dụng tay cầm phụ, nếu có, để kiểm soát tối đa lực giật lại hoặc phản lực mômen trong quá trình khởi động.** Người vận hành có thể kiểm soát phản lực mômen hoặc lực giật lại nếu thực hiện các biện pháp phòng ngừa thích hợp.
- b) **Tuyệt đối không để tay gần linh kiện đang quay.** Phụ kiện có thể đẩy ngược vào tay bạn.
- c) **Không đứng trong khu vực mà dụng cụ điện cầm tay có thể sẽ chuyển động tới khi xảy ra hiện tượng đẩy ngược.** Lực giật lại sẽ đẩy máy theo hướng ngược lại với hướng chuyển động của đĩa mài tại điểm bị kẹt.
- d) **Đặc biệt chú ý khi làm việc với các góc, cạnh sắc, v.v. Tránh làm nảy và kẹt phụ kiện.** Các góc, cạnh sắc hoặc gờ nổi có xu hướng làm kẹt phụ kiện đang quay và gây mất kiểm soát hoặc lực giật lại.
- e) **Không gắn lưới cửa gỗ dạng xích hoặc lưới cửa có răng.** Những lưới cửa này thường xuyên tạo ra lực giật lại và gây mất kiểm soát.

### Cảnh Báo An Toàn Cụ Thể cho Hoạt Động Mài và Cắt Mài Mòn:

- a) **Chỉ sử dụng loại đĩa mài được khuyến dùng cho dụng cụ điện cầm tay của bạn và vành chắn riêng được thiết kế cho đĩa mài đã chọn.** Đĩa mài không được thiết kế cho dụng cụ điện cầm tay này sẽ không được bảo vệ thích đáng và không an toàn.
- b) **Bề mặt mài của đĩa lõm tâm phải được gắn bên dưới mặt miệng vành chắn.** Đĩa nhỏ ra qua mặt miệng vành chắn nếu không được lắp đúng cách sẽ không được bảo vệ một cách tốt nhất.
- c) **Vành chắn phải được gắn chắc chắn vào công cụ điện và định vị để đảm bảo an toàn tối đa, sao cho phần bán ngoài lộ ra ngoài hướng về người vận hành là nhỏ nhất.** Vành chắn giúp bảo vệ người vận hành khỏi mảnh vụn của đĩa mài bị vỡ và tránh vô tình tiếp xúc với đĩa mài cũng như các tia lửa điện có thể gây cháy quần áo.
- d) **Chỉ sử dụng đĩa cho các ứng dụng được khuyến nghị.** Ví dụ: không mài bằng cạnh của đĩa cắt. Đĩa mài được sử dụng để mài cạnh biên; lực bên tác dụng vào các đĩa mài này có thể làm cho đĩa mài bị vỡ.
- e) **Luôn sử dụng mặt bích đĩa mài còn tốt, có kích thước và hình dạng phù hợp với đĩa mài đã chọn. Mặt bích đĩa mài phù hợp sẽ đỡ được đĩa mài, do đó làm giảm nguy cơ vỡ đĩa.** Mặt bích cho đĩa cắt có thể khác với mặt bích đĩa mài nhẵn.
- f) **Không sử dụng đĩa mài đã mòn của các dụng cụ điện cầm tay lớn hơn.** Đĩa mài được sử dụng cho dụng cụ điện cầm tay lớn hơn không thích hợp với tốc độ cao hơn của dụng cụ nhỏ hơn và có thể bị vỡ.

## Cảnh Báo An Toàn Bộ Sung Cọ Thể cho Hoạt Động Cắt Mài Mòn

- a) **Không “Siết” bánh xe cắt hoặc dùng áp lực quá mức. Đừng cố tạo ra vết cắt có độ sâu quá mức.** Việc kéo căng quá mức bánh xe làm tăng tải trọng và dễ bị xoắn hoặc vướng bánh xe trong vết cắt và có khả năng giật lại hoặc vỡ bánh xe.
- b) **Không đặt cơ thể của bạn thẳng hàng và phía sau bánh xe quay.** Khi bánh xe tại điểm hoạt động đang di chuyển ra xa cơ thể bạn, lực giật lại có thể đẩy bánh xe quay và dụng cụ điện trực tiếp vào bạn.
- c) **Khi bánh xe bị vướng hoặc khi làm gián đoạn một vết cắt vì bất kỳ lý do gì, hãy tắt công cụ điện và giữ công cụ điện bất động cho đến khi bánh xe dừng hẳn. Không bao giờ cố gắng loại bỏ bánh xe cắt khỏi vết cắt trong khi bánh xe đang chuyển động nếu không có thể xảy ra tình trạng giật lại.** Kiểm tra và thực hiện hành động khắc phục để loại bỏ nguyên nhân vướng bánh xe.
- d) **Không khởi động lại hoạt động cắt trong chi tiết gia công.** Cho phép bánh xe đạt tốc độ tối đa và nhập lại vết cắt một cách cẩn thận. Bánh xe có thể vướng, đi lên hoặc giật lại nếu công cụ điện được khởi động lại trong chi tiết gia công.
- e) **Các băng đỡ hoặc chi tiết gia công quá khổ để giảm thiểu nguy cơ chèn ép bánh xe và giật lại. Chi tiết gia công lớn có xu hướng chùng xuống do trọng lượng của chúng.** Các giá đỡ phải được đặt dưới chi tiết gia công gần đường cắt và gần mép chi tiết gia công ở cả hai mặt của bánh xe.
- f) **Cẩn thận hơn khi thực hiện “cắt túi” vào các cạnh hiện có hoặc các khu vực mù khác.** Bánh xe nhỏ ra có thể cắt phải ống dẫn khí hoặc nước, dây điện hoặc các vật thể có thể gây ra giật lại.

## Cảnh Báo An Toàn Cụ Thể cho Hoạt Động Chà Nhám

- a) **Không sử dụng giấy đĩa chà nhám quá khổ.** Làm theo khuyến nghị của nhà sản xuất khi chọn giấy chà nhám. Giấy chà nhám lớn hơn kéo dài ra ngoài miếng chà nhám có nguy cơ bị rách và có thể gây ra kẹt, rách đĩa hoặc giật ngược lại.

## Cảnh Báo An Toàn Cụ Thể đối với Sử Dụng Bàn Chài Sắt

- a) **Lưu ý rằng lông bàn chải có thể bị văng ra ngay cả khi đang vận hành bình thường. Không làm căng lông bàn chải bằng cách tác động quá tải lên bàn chải.** Lông bàn chải có thể dễ dàng xuyên thủng vào quần áo và/hoặc da.
- b) **Nếu việc sử dụng bộ bảo vệ được khuyến nghị cho việc chà bằng bàn chải sắt, không được để bánh xe sắt hoặc bàn chải sắt tiếp xúc với bộ bảo vệ.** Bánh xe sắt hoặc bàn chải sắt có thể giãn nở đường kính do làm việc và lực ly tâm.

## Các nguy cơ khác

Cho dù áp dụng các quy định an toàn liên quan và thực hiện các thiết bị an toàn, bạn cũng không thể tránh khỏi một số nguy cơ khác.

Chúng bao gồm:

- Suy giảm thính lực.
- Nguy cơ chấn thương cá nhân do các hạt bay vào người.
- Nguy cơ bị bỏng do các phụ kiện trở nên nóng trong khi vận hành.
- Nguy cơ chấn thương cá nhân do sử dụng trong một thời gian dài.
- Nguy cơ hít phải bụi từ các chất nguy hại.

## Bộ sạc

Bộ sạc DEWALT không cần điều chỉnh và được thiết kế sao cho vận hành dễ dàng hết mức có thể.

### An toàn điện

Động cơ điện chỉ được thiết kế với một mức điện áp. Luôn kiểm tra điện áp pin xem có bằng với điện áp trên tấm định mức hay không. Luôn chắc chắn rằng điện áp của bộ sạc tương ứng với điện áp nguồn.



Dụng cụ DEWALT này đã được cách điện kép theo tiêu chuẩn IEC60335; do vậy không cần dây nối đất.

Nếu dây nguồn bị hỏng, chỉ được thay thế bởi DEWALT hoặc một đơn vị dịch vụ được ủy quyền.

### Sử dụng dây điện nối dài

Không nên sử dụng dây điện nối dài trừ trường hợp thực sự cần thiết. Sử dụng dây nối dài được phê chuẩn - phù hợp với dòng điện đầu vào của bộ sạc (xem **Thông số kỹ thuật**). Kích cỡ tối thiểu cho phần dẫn điện là 1 mm<sup>2</sup>; chiều dài tối đa là 30 m. Khi sử dụng tang dây, luôn trải hết dây ra.

### Hướng dẫn an toàn quan trọng cho mọi bộ sạc pin

- Trước khi sử dụng bộ sạc, hãy đọc tất cả chỉ dẫn và những lưu ý ghi trên bộ sạc pin, pin và sản phẩm chạy bằng pin.



**CẢNH BÁO:** Nguy cơ điện giật. Không tiếp bất kỳ chất lỏng nào lọt vào bên trong bộ sạc. Có thể dẫn đến điện giật.



**CẢNH BÁO:** Bạn nên sử dụng thiết bị ngắt mạch tự động có cường độ dòng dư định mức từ 30mA trở xuống.



**THẬN TRỌNG:** Nguy cơ gây bỏng. Để giảm nguy cơ chấn thương, chỉ sạc pin có thể sạc lại của DEWALT. Sạc các loại pin khác có thể gây cháy dẫn đến chấn thương cá nhân và hỏng pin.



**THẬN TRỌNG:** Phải giám sát để đảm bảo trẻ không nghịch thiết bị.

**LƯU Ý:** Trong một số trường hợp nhất định, khi bộ sạc vẫn được nối với nguồn điện, các điểm tiếp xúc sạc hở bên trong bộ sạc có thể bị chập mạch do chất lạ. Không để các chất lạ có tính dẫn điện chẳng hạn như, nhưng không giới hạn ở, bông thép, lá nhôm hoặc bất kỳ sự tích tụ nào của các hạt kim loại dính vào các hốc của bộ sạc. Luôn rút phích cắm bộ sạc ra khỏi nguồn điện khi không có pin trong hốc bộ sạc. Rút phích cắm trước khi vệ sinh bộ sạc

- **KHÔNG sạc pin bằng bất kỳ bộ sạc nào không được khuyến dùng trong hướng dẫn sử dụng này.** Bộ sạc này được thiết kế riêng cho loại pin này.
- **Những bộ sạc này chỉ được thiết kế để sạc loại pin có thể sạc lại của DEWALT.** Sử dụng bộ sạc này cho các mục đích khác có thể dẫn đến nguy cơ hỏa hoạn, sốc điện hoặc giật điện.
- **Không để bộ sạc dưới trời mưa hoặc tuyết.**
- **Khi ngắt kết nối bộ sạc, nên cầm tay ở phần phích cắm, không nên kéo bằng dây điện.** Điều này sẽ giúp giảm nguy cơ hỏng phích cắm và dây điện.
- **Đặt dây điện ở vị trí thích hợp để tránh người khác dẫm lên dây, vướng vào dây hoặc làm hỏng hoặc làm căng dây.**
- **Không sử dụng dây nối dài trừ trường hợp thực sự cần thiết.** Sử dụng dây nối dài không thích hợp có thể dẫn đến nguy cơ hỏa hoạn, sốc điện hoặc giật điện.
- **Không để bất cứ vật gì lên trên bộ sạc hoặc không đặt bộ sạc lên trên bề mặt mềm khiến cho các khe thông gió bị chắn hoặc làm cho nhiệt độ bên trong bộ sạc tăng quá cao.** Đặt bộ sạc ở nơi cách xa mọi nguồn nhiệt. Bộ sạc được thông gió qua các khe ở phía trên và phía dưới nó.
- **Không sử dụng bộ sạc khi dây điện hoặc phích cắm bị hỏng** — thay ngay dây điện hoặc phích cắm hỏng.
- **Không vận hành bộ sạc nếu nó bị va đập mạnh, bị rơi hoặc bị hỏng.** Hãy đem đến trung tâm dịch vụ ủy quyền.
- **Không tháo rời bộ sạc; hãy đem bộ sạc đến trung tâm dịch vụ được ủy quyền khi cần bảo dưỡng hoặc sửa chữa.** Việc lắp lại không đúng có thể dẫn đến nguy cơ bị sốc điện, giật điện hoặc hỏa hoạn.
- Trong trường hợp dây cáp nguồn bị hỏng, việc thay thế phải được thực hiện ngay bởi nhà sản xuất, đại lý bảo dưỡng hoặc người có đủ chuyên môn để tránh gây nguy hiểm.
- **Ngắt kết nối bộ sạc khỏi ổ cắm điện trước khi vệ sinh.** Điều này sẽ giúp giảm nguy cơ bị giật điện. Tháo pin sẽ không giúp giảm nguy cơ này.
- **TUYỆT ĐỐI KHÔNG** nối hai bộ sạc với nhau.
- **Bộ sạc được thiết kế để hoạt động bằng nguồn điện gia đình chuẩn 220-240V.** Không cắm bộ sạc vào nguồn điện có điện áp khác. Điều này không áp dụng với bộ sạc trên xe.

**Sạc pin (Hình B)**

1. Cắm bộ sạc vào ổ cắm thích hợp trước khi lắp bộ pin.
2. Lắp bộ pin **10** vào bộ sạc, đảm bảo rằng bộ pin được đặt hoàn toàn trong bộ sạc. Đèn sạc màu đỏ (đang sạc) sẽ nhấp nháy liên tục cho biết quá trình sạc đã bắt đầu.
3. Việc hoàn tất quá trình sạc sẽ được chỉ báo bằng đèn sạc màu đỏ vẫn **BẬT** liên tục. Bộ pin đã được sạc đầy và có thể được sử dụng tại thời điểm này hoặc để lại trong bộ sạc. Để tháo pin khỏi bộ sạc, hãy đẩy nút tháo pin **11** trên bộ pin.

**LƯU Ý:** Để đảm bảo hiệu suất và tuổi thọ tối đa của bộ pin lithium ion , hãy sạc đầy bộ pin trước khi sử dụng lần đầu.

**Thao tác sạc**

Tham khảo các chỉ báo bên dưới để biết trạng thái sạc của bộ pin.

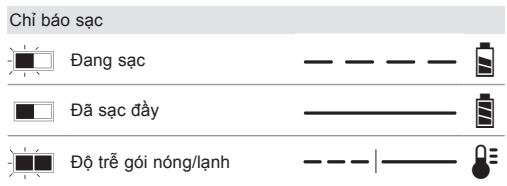

\*Đèn đỏ sẽ tiếp tục nhấp nháy, nhưng đèn chỉ báo màu vàng sẽ sáng trong quá trình này. Khi pin đã đạt nhiệt độ thích hợp, đèn vàng sẽ tắt và bộ sạc sẽ tiếp tục quy trình sạc.

Các bộ sạc tương thích sẽ không sạc được bộ pin bị lỗi. Bộ sạc sẽ chỉ báo pin bị lỗi bằng cách không sáng.

**GHI CHÚ:** Điều này cũng có thể là sự cố với bộ sạc.

Nếu bộ sạc có vấn đề, hãy mang bộ sạc và pin đi kiểm tra tại trung tâm dịch vụ được ủy quyền.

**Độ trễ Bộ nguồn Nóng/Lạnh**

Khi bộ sạc phát hiện thấy bộ pin quá nóng hoặc quá lạnh, nó sẽ tự động khởi động Độ trễ Pin Nóng/Lạnh, tạm ngừng sạc cho đến khi bộ pin đạt đến nhiệt độ phù hợp. Sau đó, bộ sạc sẽ tự động chuyển sang chế độ sạc bộ nguồn. Tính năng này đảm bảo tuổi thọ bộ pin tối đa.

Bộ pin lạnh sẽ sạc với tốc độ chậm hơn pin ấm. Bộ pin sẽ sạc ở tốc độ chậm hơn trong toàn bộ quá trình sạc và sẽ không trở lại tốc độ sạc tối đa ngay cả khi bộ pin ấm lên.

Bộ sạc DCB118 được trang bị một quạt bên trong được thiết kế để làm mát bộ pin. Quạt sẽ tự động bật khi bộ pin cần được làm mát. Không được sử dụng bộ sạc nếu quạt hoạt động không bình thường hoặc nếu các khe thông gió bị chặn. Không để các vật thể lạ xâm nhập vào bên trong bộ sạc.

**Hệ thống Bảo vệ Điện tử**

Các công cụ XR Li Ion được thiết kế với Hệ thống Bảo vệ Điện tử sẽ bảo vệ bộ pin khỏi tình trạng quá tải, quá nhiệt hoặc xả kiệt.

Công cụ sẽ tự động tắt nếu Hệ thống Bảo vệ Điện tử hoạt động. Nếu điều này xảy ra, hãy lắp bộ pin lithium ion vào bộ sạc cho đến khi nó được sạc đầy.

**Giá gắn tường**

Những bộ sạc này được thiết kế có thể treo tường hoặc để đứng thẳng trên bàn hoặc bề mặt làm việc. Nếu gắn tường, hãy đặt bộ sạc trong phạm vi gần ổ cắm điện và tránh góc hoặc các vật cản cản trở luồng không khí khác. Sử dụng mặt sau của bộ sạc để đo mẫu vị trí của các vít gắn tường. Gắn bộ sạc một cách chắc chắn bằng vít vận tường (mua riêng) dài ít nhất 25,4 mm với đường kính đầu vít từ 7–9 mm, được vận vào góc đến độ sâu tối ưu để hở ra khoảng 5,5 mm vít. Căn chỉnh các khe ở mặt sau của bộ sạc với các vít đã lộ ra và gắn chúng hoàn toàn vào các khe.

**Hướng dẫn vệ sinh bộ sạc**

**⚠ CẢNH BÁO:** *Nguy cơ điện giật. Ngắt kết nối bộ sạc khỏi ổ cắm điện xoay chiều trước khi thực hiện công tác vệ sinh. Bụi và dầu có thể được loại bỏ khỏi vỏ ngoài của bộ sạc bằng cách sử dụng vải hoặc bàn*

chải mềm phi kim. Không sử dụng nước hoặc bất kỳ dung dịch tẩy rửa nào. Tuyệt đối không để chất lỏng lọt vào bên trong máy; không được ngâm các bộ phận của máy vào chất lỏng.

**Pin**

**Hướng dẫn an toàn quan trọng cho mọi bộ sạc pin**

Khi mua bộ pin thay thế, hãy đảm bảo việc bao gồm mã số danh mục và điện áp.

Bộ pin chưa được sạc đầy khi bỏ ra khỏi hộp. Trước khi sử dụng bộ pin và bộ sạc, hãy đọc các hướng dẫn an toàn dưới đây. Sau đó làm theo các quy trình sạc đã nêu.

**ĐỌC TẤT CẢ HƯỚNG DẪN**

- **Không sạc hoặc sử dụng pin trong các môi trường dễ cháy nổ, chẳng hạn như các môi trường có chất lỏng, khí hoặc bụi dễ cháy.** Lắp hoặc tháo pin ra khỏi bộ sạc có thể gây cháy nổ hoặc bốc khói.
- **Tuyệt đối không có lắp pin vào bộ sạc. Không được sửa đổi pin theo bất kỳ cách nào để lắp vừa vào bộ sạc không tương thích vì pin có thể gây gây ra chấn thương cá nhân nghiêm trọng.**
- Chỉ sạc pin trong bộ sạc của DEWALT.
- **KHÔNG** vẩy nước vào pin hoặc nhúng pin vào nước hoặc các chất lỏng khác.
- **Không lưu trữ hoặc sử dụng dụng cụ và bộ pin ở những nơi nhiệt độ có thể hạ xuống dưới 4°C (39.2°F) (chẳng hạn như nhà kho bên ngoài hoặc các tòa nhà bằng kim loại vào mùa đông) hoặc đặt hoặc vượt quá 40°C (105°F) (chẳng hạn như nhà kho ngoài trời hoặc các tòa nhà bằng kim loại vào mùa hè).**
- **Không thiêu hủy pin ngay cả khi pin đã hỏng hoàn toàn hoặc bị mòn hết.** Pin có thể nổ khi bị thiêu hủy. Việc thiêu hủy pin Li-ion sẽ sinh ra khói và các chất độc.
- **Nếu dung dịch của pin dính vào da của bạn, hãy rửa ngay bằng xà phòng có tính tẩy nhẹ và nước.** Nếu chất lỏng chảy ra từ pin dính vào mắt, hãy mở mắt và rửa bằng nước sạch trong 15 phút hoặc cho tới khi hết bị kích ứng. Hãy điều trị y tế ngay nếu tiếp xúc với chất điện phân của pin gồm hỗn hợp cacbonat hữu cơ lỏng và muối lithi.
- **Dung dịch chảy ra từ pin hồ có thể gây kích ứng hô hấp.** Hãy hít thở không khí trong lành. Nếu không hết các triệu chứng, hãy tìm sự trợ giúp y tế.

 **CẢNH BÁO:** Nguy cơ gây bỏng. Chất lỏng chảy ra từ pin có thể bắt lửa nếu tiếp xúc với tia lửa hoặc ngọn lửa.

 **CẢNH BÁO:** Tuyệt đối không mở pin vì bất cứ lý do gì. Nếu vỏ pin bị nứt hoặc bị hỏng, không được lắp vào bộ sạc. Không để lên, đánh rơi hoặc làm hỏng pin. Không sử dụng pin hoặc bộ sạc bị va đập mạnh, bị rơi, bị dẫm lên hoặc bị làm hỏng bằng bất kỳ cách nào (ví dụ: bị móng tay chọc vào, bị búa đập vào, bị dẫm lên). Điều này có thể gây điện giật hoặc tử vong. Bạn nên trả lại pin hỏng cho trung tâm dịch vụ để tái chế.

 **CẢNH BÁO:** Nguy cơ hỏa hoạn. Không bảo quản hoặc cắm pin khi các vật bằng kim loại có thể tiếp

xúc với cực pin hở. Ví dụ, không để pin trong tạp dề, túi, hộp máy, hộp đựng bộ sản phẩm, ngăn kéo, v.v. cùng với đinh, vít, chìa khóa, v.v.

 **THẬN TRỌNG:** Khi không sử dụng, đặt nằm máy trên bề mặt chắc chắn để máy không bị trượt hoặc bị rơi. Một số máy có pin lớn sẽ đứng thẳng được nhờ có pin nhưng dễ bị đổ.

**Vận chuyển**

 **CẢNH BÁO: NGUY CƠ HỎA HOẠN.** Việc vận chuyển pin có thể gây cháy nổ nếu các cực pin vô tình tiếp xúc với các vật dẫn điện. Khi vận chuyển pin, đảm bảo rằng các cực của pin được bảo vệ đồng thời được cách ly khỏi các vật liệu có thể kết nối các cực của pin với nhau và gây hiện tượng chập mạch.

**LƯU Ý:** Không nên để pin LI-ION trong hành lý ký gửi.

Pin DEWALT tuân thủ tất cả các quy định vận chuyển hiện hành theo tiêu chuẩn công nghiệp và quy phạm pháp luật bao gồm Khuyến nghị của Liên hợp quốc về vận chuyển hàng hoá nguy hiểm; Hiệp hội Vận tải Hàng không quốc tế (IATA), Quy định Hàng hóa Nguy hiểm, Quy định về hàng hóa nguy hiểm trong hàng hải quốc tế (IMDG) và Hiệp định của Châu Âu về Vận chuyển quốc tế hàng nguy hiểm đường bộ (ADR). Pin Lithium-ion đã được thử nghiệm theo phần 38.3 của Khuyến nghị của Liên Hợp Quốc về vận chuyển hàng hóa nguy hiểm, Sách hướng dẫn thử nghiệm và tiêu chí.

Trong hầu hết các trường hợp, việc vận chuyển pin DEWALT sẽ không bị phân loại là Vật liệu nguy hại Loại 9 như đã quy định. Nhìn chung, bất kỳ lô hàng có chứa pin lithium-ion nào có mật độ năng lượng lớn hơn 100 watt giờ (Wh) sẽ yêu cầu loại hình vận chuyển là Loại 9. Tất cả pin lithium-ion đều có ghi mức Watt giờ trên pin. Ngoài ra, do các quy định phức tạp, DEWALT không khuyến khích vận chuyển pin lithium-ion bằng đường hàng không, bất kể mức Watt giờ là bao nhiêu. Một trường hợp ngoại lệ là cho phép vận chuyển máy có gắn pin (bộ máy tổ hợp) theo đường hàng không nếu mật độ năng lượng của pin không vượt quá 100 Whr.

Cho dù lô hàng nằm trong trường hợp ngoại lệ hoặc hoàn toàn theo quy định, việc tham khảo quy định mới nhất đối với việc đóng gói, dán nhãn/dán dấu và yêu cầu tài liệu thuộc trách nhiệm của người gửi.

Thông tin được cung cấp trong phần này của sách hướng dẫn là đáng tin cậy và chính xác tại thời điểm tạo ra tài liệu này. Tuy nhiên, không cung cấp bảo hành, dưới hình thức nêu rõ ràng hay ngụ ý. Người mua chịu trách nhiệm đảm bảo rằng các hoạt động phải tuân thủ đúng theo các quy định hiện hành.

**Vận chuyển Pin FLEXVOLT™**

Pin DEWALT FLEXVOLT™ có hai chế độ: **Sử dụng** và **Vận chuyển**.

**Chế độ Sử dụng:** Khi pin FLEXVOLT™ đứng riêng hoặc nằm trong sản phẩm DEWALT 18V(20V MAX), nó sẽ hoạt động như một pin 18V(20V MAX). Khi pin FLEXVOLT™ nằm trong một sản phẩm 54V(60V MAX) hoặc 108V(120V MAX) (hai pin 54V(60V MAX)), nó sẽ hoạt động như một pin 54V(60V MAX).

**Chế độ Vận chuyển:** Khi nắp được lắp vào pin FLEXVOLT™, pin sẽ ở chế độ Vận chuyển. Giữ chặt nắp để vận chuyển..

Khi ở chế độ Vận chuyển, các chuỗi pin được ngắt kết nối điện trong bộ pin dẫn đến 3 pin có công suất Watt giờ (Wh) thấp

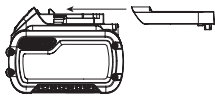

hơn so với 1 pin có công suất Watt giờ cao hơn. Số lượng tăng lên của 3 pin với công suất Watt giờ thấp hơn có thể giúp cho bộ pin tránh khỏi các quy định vận chuyển nhất định được áp dụng đối với pin Watt giờ cao hơn.

Ví dụ, Công suất Wh vận chuyển có thể chỉ ra 3 x 36 Wh, nghĩa là 3 pin 36 Wh mỗi pin. Công suất Wh sử dụng có thể chỉ ra 108 Wh (nghĩa là 1 pin).

Ví dụ về việc sử dụng và vận chuyển nhân Đánh dấu

**Use: 108 Wh**

**Transport: 3x36 Wh**

### Khuyến cáo bảo quản

- Nên bảo quản ở nơi mát mẻ và khô ráo, tránh ánh sáng mặt trời chiếu trực tiếp và không quá nóng hoặc quá lạnh. Để có hoạt động và tuổi thọ pin tối ưu, hãy bảo quản pin ở nhiệt độ phòng khi không sử dụng.
- Đối với việc bảo quản trong thời gian dài, chúng tôi khuyến bạn nên bảo quản pin đã sạc đầy ở nơi khô ráo thoáng mát và tháo khỏi bộ sạc để cho kết quả tối ưu.

**Lưu ý:** Khi bảo quản pin, không nên để pin ở trạng thái hoàn toàn hết điện. Cần sạc lại pin trước khi sử dụng.

### Nhãn trên bộ sạc và pin

Ngoài hình được sử dụng trong tài liệu hướng dẫn này, nhãn trên bộ sạc và pin có thể chỉ các hình vẽ sau:



Đọc kỹ hướng dẫn sử dụng trước khi dùng.



Xem Thông số kỹ thuật để biết thời gian sạc pin.



Không kiểm tra bằng các đồ vật dẫn điện.



Không sạc pin đã hỏng.



Không được tiếp xúc với nước.



Lập tức thay dây nguồn đã hỏng.



Chỉ sạc ở mức nhiệt độ 4 °C và 40 °C.



Chỉ sử dụng trong nhà.



LI-ION



DCBXXX

Thận trọng khi thải bỏ pin để bảo vệ môi trường.

Chỉ sạc pin DEWALT bằng bộ sạc DEWALT được khuyến nghị. Việc sạc pin khác ngoài pin DEWALT được khuyến nghị bằng bộ sạc DEWALT có thể làm cho chúng bị nổ hoặc gây ra các tình huống nguy hiểm khác.



Không đốt pin.



**SỬ DỤNG** (không có nắp vận chuyển). Ví dụ: Công suất Wh chỉ ra 108 Wh (1 pin có 108 Wh).



**VẬN CHUYỂN** (có nắp vận chuyển tích hợp). Ví dụ: Công suất Wh chỉ ra 3 x 36 Wh (3 pin có 36 Wh).

### Loại pin

Các công cụ sau hoạt động với bộ pin tối đa 18 (20 Max)vôn: DCG409

Những bộ pin này có thể được sử dụng: DCB181, DCB182, DCB183, DCB183B, DCB184, DCB184B, DCB185, DCB186, DCB187, DCB189, DCB203, DCB204, DCB205, DCB240, DCB546, DCB547, DCB548, DCB606, DCB609, DCB612. Tham khảo **dữ liệu Kỹ thuật** để biết thêm thông tin.

### Thiết bị trong hộp

Hộp sản phẩm bao gồm:

- Máy mài góc
- bộ bảo vệ 125 mm (Loại 27)
- Tay cầm phụ
- bộ mặt bích
- Cờ lê lục giác
- Bộ pin Li-Ion (các model C1, D1, L1, M1, P1, S1, T1, X1, Y1)
- Bộ pin Li-Ion (các model C2, D2, L2, M2, P2, S2, T2, X2, Y2)
- Bộ pin Li-Ion (các model C3, D3, L3, M3, P3, S3, T3, X3, Y3)
- Hướng dẫn sử dụng

**GHI CHÚ:** Bộ pin, bộ sạc và hộp đựng đồ nghề không được bao gồm trong các model N. Bộ pin và bộ sạc không được bao gồm trong các model NT. Các model B bao gồm bộ pin Bluetooth®

**GHI CHÚ:** Logo và nhãn hiệu Bluetooth® là các nhãn hiệu đã đăng ký thuộc sở hữu của Bluetooth®, SIG, Inc. Và việc sử dụng các nhãn hiệu này của DEWALT đều phải được cấp phép. Các nhãn hiệu và tên thương mại khác cũng thuộc chủ sở hữu tương ứng.

- Kiểm tra máy, các bộ phận hoặc phụ kiện xem có bị hư hỏng do quá trình vận chuyển hay không.
- Dành thời gian đọc kỹ và hiểu rõ hướng dẫn sử dụng trước khi vận hành máy.

### Ký hiệu trên dụng cụ

Trên dụng cụ có các ký hiệu sau:



Đọc kỹ hướng dẫn sử dụng trước khi dùng.



Đeo thiết bị bảo vệ tai.



Đeo kính bảo hộ.

## Vị trí mã ngày (Hình E)

Mã ngày **12**, bao gồm cả năm sản xuất, được in trên vỏ máy.

Ví dụ:

2021 XX XX

Năm và tuần sản xuất

## Mô tả (Hình A)



**CẢNH BÁO:** Tuyệt đối không sửa máy điện cầm tay hay bất kỳ bộ phận nào của máy. Việc sửa có thể làm hỏng máy điện cầm tay hoặc gây chấn thương cá nhân.

- 1 Công tắc trượt
- 2 Cần gạt khóa
- 3 Nút khóa trục quay
- 4 Trục chính
- 5 Tay cầm phụ
- 6 Mặt bích đệm
- 7 Mặt bích khóa
- 8 Tấm bảo vệ
- 9 Cần nhả bộ bảo vệ
- 10 Bộ pin
- 11 Nút tháo pin

## Mục đích sử dụng

Máy mài góc dùng Pin DCG409 được thiết kế cho các ứng dụng cắt, mài, chà nhám và chà bằng bàn chải sắt chuyên nghiệp.

**Không** sử dụng máy ở những nơi ẩm ướt hoặc có chất lỏng hoặc khí dễ cháy.

Máy mài góc không dây này là một công cụ điện chuyên nghiệp.

**Không** để trẻ em tiếp xúc với máy. Cần phải có người giám sát khi máy này được vận hành bởi người chưa có kinh nghiệm.

- **Trẻ em và người không đủ sức khỏe.** Thiết bị này không được thiết kế cho trẻ em hoặc người không đủ sức khỏe sử dụng mà không có sự giám sát.
- Không cho phép những người (bao gồm cả trẻ em) bị suy giảm năng lực thể chất, trí tuệ hoặc cảm giác, hay người thiếu kinh nghiệm, kiến thức hoặc kỹ năng dùng dụng cụ điện cầm tay này, trừ khi có sự giám sát của người chịu trách nhiệm về vấn đề an toàn của họ. Không được để trẻ em một mình với sản phẩm này.

## Đặc Điểm

### Công tắc No-Volt

Chức năng No-volt dừng máy mài khởi động lại mà không cần chuyển đổi theo chu kỳ nếu nguồn điện bị gián đoạn.

### Ly Hợp Điện Tử

Thiết bị này được trang bị E-Clutch™ (Ly hợp Điện tử), trong trường hợp tải trọng cao, hoặc bánh xe bị ép, bộ phận này sẽ được ngắt để giảm lực mô-men xoắn phản hồi ngược lại tới

người sử dụng. Công tắc cần được chạy theo chu kỳ (bật và tắt) để khởi động lại công cụ.

### Kickback Brake™

Khi cảm thấy có sự cố chèn ép, chònh chành hoặc bó cứng, phanh điện tử sẽ giảm với lực tối đa để nhanh chóng dừng bánh xe, giảm chuyển động của máy mài và tắt máy mài. Công tắc sẽ cần được nhấn sau đó nhấn để khởi động lại công cụ.

### Bảo Vệ Quá Tải Power OFF™

Nguồn cấp điện cho động cơ sẽ bị giảm trong trường hợp động cơ bị quá tải. Khi động cơ tiếp tục quá tải, công cụ sẽ tắt. Công tắc sẽ cần được nhấn sau đó nhấn để khởi động lại công cụ.

Công cụ sẽ tắt nguồn mỗi khi tải dòng đạt đến giá trị dòng quá tải (điểm đốt cháy động cơ). Nếu hiện tượng tắt máy do quá tải tiếp tục xảy ra, hãy tác động ít lực/trọng lượng hơn lên công cụ cho đến khi công cụ hoạt động mà không bị quá tải.

### Tính Năng Khởi Động Mềm

Tính năng khởi động mềm cho phép tích hợp tốc độ chậm để tránh bị giật ban đầu khi khởi động. Tính năng này đặc biệt hữu ích khi làm việc trong không gian hạn chế.

### Tay Cầm Phụ Chống Rung

Tay cầm phụ chống rung mang lại sự thoải mái hơn bằng cách hạn chế các rung động do công cụ gây ra.

## Lắp ráp và điều chỉnh



**CẢNH BÁO:** Để giảm nguy cơ chấn thương cá nhân nghiêm trọng, hãy tắt máy trước khi thực hiện bất kỳ điều chỉnh nào hoặc tháo/lắp các giá nối hoặc phụ kiện. Việc vô tình khởi động có thể gây chấn thương.



**CẢNH BÁO:** Chỉ sử dụng pin và bộ sạc DEWALT.

## Lắp và Tháo Bộ pin ra khỏi Công cụ (Hình B)

**GHI CHÚ:** Phải đảm bảo rằng bộ pin **10** của bạn đã được sạc đầy.

### Cách Lắp đặt Bộ pin vào Tay cầm Công cụ

1. Căn chỉnh bộ pin **10** với các đường ren bên trong tay cầm của công cụ (Hình B).
2. Trượt nó vào tay cầm cho đến khi bộ pin được lắp chắc chắn vào công cụ và đảm bảo rằng bạn nghe thấy tiếng khóa cài vào đúng vị trí.

### Cách Tháo Bộ pin ra khỏi công cụ

1. Nhấn nút tháo **11** và kéo một cách chắc chắn pin ra khỏi tay cầm công cụ.
2. Lắp bộ pin vào bộ sạc như được mô tả trong phần bộ sạc của hướng dẫn sử dụng này.

### Bộ Pin có Bộ đo Nguồn (Hình C)

Một số bộ pin DEWALT có một bộ đo nguồn bao gồm ba đèn LED màu xanh lá cho biết mức sạc còn lại trong bộ pin.

Để kích hoạt bộ đo nguồn **19**, hãy nhấn và giữ nút bộ đo nguồn. Sự kết hợp của ba đèn LED màu xanh lá sẽ bật sáng cho biết mức sạc còn lại. Khi mức sạc ở pin dưới mức giới hạn



có thể sử dụng, bộ đo nguồn sẽ không sáng và pin sẽ cần được sạc lại.

**GHI CHÚ:** Bộ đo nguồn chỉ là một chỉ báo về mức sạc còn lại trên bộ pin. Nó không thể hiện chức năng của công cụ và có thể thay đổi dựa trên các thành phần sản phẩm, nhiệt độ và ứng dụng của người dùng cuối.

## Gắn tay cầm bên(Hình C)

**!** **CẢNH BÁO:** Trước khi sử dụng dụng cụ, kiểm tra xem tay cầm đã được gắn chặt chưa.

Vận chặt tay cầm phụ **5** vào một trong các lỗ ở hai bên của hộp số. Tay cầm bên sườn luôn luôn được sử dụng để duy trì kiểm soát công cụ mọi lúc.

## Xoay Hộp Số (Hình D)

Để cải thiện sự thoải mái cho người dùng, hộp số sẽ quay 90° để thực hiện các thao tác cắt.

1. Tháo bốn vít góc gắn hộp bánh số với vỏ động cơ.
2. Không tách hộp số khỏi vỏ động cơ, xoay đầu hộp số đến vị trí mong muốn.

**LƯU Ý:** Nếu hộp số và vỏ động cơ bị tách ra quá 3,17 mm, công cụ phải được bảo dưỡng và lắp ráp lại bởi Trung tâm dịch vụ DEWALT. Việc không bảo dưỡng công cụ có thể gây hỏng động cơ và ổ trục.

3. Lắp lại các vít để gắn hộp số vào vỏ động cơ. Vận chặt các vít đến mức mô-men xoắn 12,5 in.-lbs. Siết quá chặt có thể khiến ốc vít bị bung ra.

## Bộ Bảo Vệ

**!** **THẬN TRỌNG:** Các bộ bảo vệ phải được sử dụng với tất cả các bánh mài, bánh cắt, đĩa nhám, bàn chải sắt và bánh xe sắt. Chỉ có thể sử dụng công cụ này mà không có bộ bảo vệ khi chà nhám bằng đĩa nhám thông thường. Tham khảo Hình A để xem các bộ bảo vệ được cung cấp cùng với thiết bị. Một số ứng dụng có thể yêu cầu mua bộ bảo vệ chính xác từ đại lý địa phương hoặc trung tâm dịch vụ được ủy quyền.

**LƯU Ý:** Việc mài và cắt cạnh có thể được thực hiện với bánh xe Loại 27 được thiết kế và chỉ định cho mục đích này; Bánh xe dày 6,35 mm được thiết kế để mài bề mặt trong khi bánh xe Loại 27 mỏng hơn cần được kiểm tra nhãn của nhà sản xuất để xem chúng có thể được sử dụng để mài bề mặt hay chỉ dùng để mài/cắt cạnh. Bộ bảo vệ Loại 1 phải được sử dụng cho mọi bánh xe cầm mài bề mặt. Việc cắt cạnh có thể được thực hiện bằng cách sử dụng bánh xe Loại 41 và bộ bảo vệ Loại 1.

**LƯU Ý:** Xem **Biểu Đồ Phụ KIỆN** để chọn kết hợp bộ bảo vệ/phụ kiện phù hợp.

## Gắn và Điều Chỉnh Bộ Bảo Vệ One Touch™ (Hình E)

**!** **CẢNH BÁO:** Để giảm nguy cơ thương tích cá nhân khi thực hiện bất kỳ việc điều chỉnh nào hoặc tháo dỡ/lắp các bộ phận đi kèm hoặc phụ kiện. Việc khởi động không cẩn thận có thể gây ra chấn thương.

## Điều Chỉnh Bộ Bảo Vệ

Để điều chỉnh bộ bảo vệ, cần nhả bộ cần **9** gài vào một trong các lỗ căn chỉnh **15** trên vòng đệm bảo vệ bằng cách sử dụng tính năng bành cóc

Mặt gài bị nghiêng và sẽ chuyển sang lỗ căn chỉnh tiếp theo khi bộ bảo vệ được xoay theo chiều kim đồng hồ (người sử dụng quay mặt về trục chính) nhưng tự khóa theo hướng ngược chiều kim đồng hồ.

## Gắn Bộ Bảo Vệ (Hình E)

1. Nhấn cần nhả bộ bảo vệ **9**.
2. Trong khi giữ cần nhả bộ bảo vệ mở, căn chỉnh các vấu **13** trên bộ bảo vệ với các khe **14** trên hộp số.
3. Giữ cần nhả bộ bảo vệ mở, đẩy bộ bảo vệ xuống cho đến khi các vấu bộ bảo vệ gài vào và xoay chúng theo rãnh trên trục hộp số. Nhả cần nhả bộ bảo vệ.
4. Với trục chính đối diện với người vận hành, xoay bộ bảo vệ theo chiều kim đồng hồ vào vị trí làm việc mong muốn. Nhấn và giữ cần nhả bộ bảo vệ **9** để xoay bộ bảo vệ theo hướng ngược chiều kim đồng hồ.

**LƯU Ý:** Thân bộ bảo vệ phải được định vị giữa trục chính và người vận hành để bảo vệ tối đa người vận hành. Cần nhả bộ bảo vệ phải gài vào một trong các lỗ căn chỉnh 15 trên vỏ bộ bảo vệ. Điều này đảm bảo rằng bộ bảo vệ được an toàn.

5. Để tháo bộ bảo vệ, hãy thực hiện ngược lại các bước từ 1 đến 3 trong số các hướng dẫn này.

## Mặt Bích và Bánh Xe

### Gắn Bánh Xe Không Trục (Hình F)

**!** **CẢNH BÁO:** Không đặt đúng vị trí của mặt bích/đai ốc kẹp/bánh xe có thể dẫn đến thương tích nghiêm trọng (hoặc làm hỏng công cụ hoặc bánh xe).

**!** **THẬN TRỌNG:** Mặt bích đi kèm phải được sử dụng với bánh mài Loại 27 và Loại 42 có tâm lõm và bánh cắt Loại 41. Xem **Biểu Đồ Phụ KIỆN** để biết thêm thông tin.

**!** **CẢNH BÁO:** Cần phải có bộ bảo vệ bánh xe cắt hai bên, đồng kín khi sử dụng bánh xe cắt.

**!** **CẢNH BÁO:** Việc sử dụng mặt bích hoặc bộ bảo vệ bị hư hỏng hoặc không sử dụng mặt bích và bộ bảo vệ phù hợp có thể dẫn đến thương tích do vỡ bánh xe và tiếp xúc với bánh xe. Xem **Biểu Đồ Phụ KIỆN** để biết thêm thông tin.

1. Đặt công cụ trên bàn, bảo vệ.
2. Lắp mặt bích đệm **6** trên trục chính **4** với tâm nâng (hoa tiêu) đối diện với bánh xe. Nhấn mặt bích đệm vào vị trí.
3. Đặt bánh xe **20** tựa vào mặt bích đệm, đặt trọng tâm của bánh xe vào tâm nâng lên (hoa tiêu) của mặt bích đệm.
4. Trong khi nhấn nút khóa trục chính và với các chốt lõm hình lục giác hướng ra khỏi bánh xe, vận mặt bích khóa **7** lên trục chính sao cho các vấu gài vào hai rãnh trên trục chính.
5. Trong khi nhấn nút khóa trục chính, hãy siết chặt mặt bích khóa **7** bằng tay hoặc sử dụng cờ lê đi kèm. (Chỉ sử dụng mặt bích khóa nếu nó ở trong tình trạng tốt.) Tham khảo Biểu Đồ Phụ KIỆN để xem thêm về mặt bích.
6. Để tháo bánh xe, hãy thao tác ngược lại quy trình trên.

### Gắn Tấm Đệm Lót Chà Nhám (Hình G)

**LƯU Ý:** Việc sử dụng bộ bảo vệ với các đĩa chà nhám sử dụng các tấm đệm lót, thường được gọi là đĩa nhựa sùi là không bắt buộc. Vì các phụ kiện này không cần có bộ bảo vệ nên bộ bảo vệ có thể khớp hoặc không khớp nếu được sử dụng.



**CẢNH BÁO:** Không đặt đúng vị trí của mặt bích/đai ốc kẹp/bánh xe có thể dẫn đến thương tích nghiêm trọng (hoặc làm hỏng công cụ hoặc bánh xe).



**CẢNH BÁO:** Phải lắp lại bộ bảo vệ phù hợp cho các ứng dụng bằng mài, bành cắt, đĩa nhám, bàn chải sắt hoặc bánh xe sắt sau khi hoàn tất các ứng dụng chà nhám.

1. Đặt hoặc luồn tấm đệm lót có ren **17** vào trục chính một cách phù hợp.
2. Đặt đĩa chà nhám **18** trên tấm đệm lót **17**.
3. Trong khi nhấn khóa trục chính **3**, đai ốc kẹp có ren **16** trên trục chính, điều khiển trục nâng trên đai ốc kẹp vào tâm của đĩa chà nhám và tấm đệm lót.
4. Vặn chặt đai ốc kẹp bằng tay. Sau đó nhấn nút khóa trục chính trong khi xoay đĩa chà nhám cho đến khi đĩa chà nhám và đai ốc kẹp khớp với nhau.
5. Để tháo bánh xe, hãy nắm và xoay tấm đệm lót và đệm nhám trong khi nhấn nút khóa trục chính.

### Gắn và Tháo Bánh Xe Có Trục (Hình F)

Bánh xe có trục lắp trực tiếp trên trục chính có ren. Ren của phụ kiện phải khớp với ren của trục chính.

1. Tháo mặt bích đệm bằng cách kéo ra khỏi công cụ.
2. Vặn bánh xe vào trục chính **4** bằng tay.
3. Nhấn nút khóa trục chính **3** và sử dụng cờ lê để siết chặt trục bánh xe.
4. Thao tác ngược lại quy trình trên để tháo bánh xe.

**LƯU Ý:** Việc không đặt đúng vị trí bánh xe trước khi bật công cụ có thể dẫn đến hỏng công cụ hoặc bánh xe.

### Gắn Bàn Chải Sắt Đánh Bóng và Bánh Xe Sắt (Hình A)



**CẢNH BÁO:** Không đặt đúng vị trí của mặt bích/đai ốc kẹp/bánh xe có thể dẫn đến thương tích nghiêm trọng (hoặc làm hỏng công cụ hoặc bánh xe).



**THẬN TRỌNG:** Để giảm nguy cơ gây thương tích cá nhân, hãy đeo găng tay lao động khi thao tác bàn chải sắt và bánh xe sắt. Chúng có thể trở nên sắc lẹm.



**THẬN TRỌNG:** Để giảm nguy cơ hư hỏng công cụ, bánh xe hoặc bàn chải không được chạm vào bộ bảo vệ khi lắp hoặc khi đang sử dụng. Các hư hỏng không thể phát hiện được có thể xảy ra đối với phụ kiện, khiến dây bị đứt ra khỏi bánh xe hoặc cốc phụ kiện.

Bàn chải sắt hoặc bánh xe sắt đánh bóng lắp trực tiếp trên trục chính có ren mà không cần sử dụng mặt bích. Chỉ sử dụng bàn chải sắt hoặc bánh xe sắt được cung cấp có một trục ren. Các phụ kiện này có sẵn với một khoan phụ phù từ đại lý địa phương hoặc trung tâm dịch vụ được ủy quyền của bạn.

1. Đặt công cụ trên bàn, bảo vệ.
2. Luồn bánh xe vào trục chính bằng tay.

3. Nhấn nút khóa trục chính **3** và sử dụng cờ lê trên trục của bánh xe sắt hoặc bàn chải sắt để siết chặt bánh xe.
4. Để tháo bánh xe, hãy thao tác ngược lại quy trình trên.

**LƯU Ý:** Để giảm nguy cơ hư hỏng công cụ, hãy đặt trục bánh xe đúng cách trước khi bật công cụ.

### Trước khi vận hành

- Lắp vành chắn và loại đĩa phù hợp. Không sử dụng đĩa mài đã bị mòn quá mức.
- Đảm bảo các mặt bích trong và ngoài được gắn đúng cách. Làm theo hướng dẫn trong **Biểu đồ phụ kiện**.
- Đảm bảo đĩa hoặc đĩa mài quay theo hướng mũi tên trên phụ kiện và dụng cụ.
- Không sử dụng phụ kiện đã bị hỏng. Trước mỗi lần sử dụng, hãy kiểm tra các phụ kiện như bánh mài xem có mảnh vỡ và vết nứt không, đệm lót phía sau có vết nứt, rách hoặc mòn quá mức không, bàn chải sắt có lỏng hoặc đứt dây không. Nếu công cụ hoặc phụ kiện điện bị rơi, hãy kiểm tra xem nó có hư hỏng không hoặc lắp phụ kiện không bị hư hỏng. Sau khi kiểm tra và lắp một phụ kiện, bạn và những người xung quanh phải cách xa mặt phẳng của phụ kiện quay và chạy công cụ điện ở tốc độ không tải tối đa trong một phút. Các phụ kiện bị hư hỏng thường sẽ bị vỡ trong thời gian chạy thử này.

### VẬN HÀNH

#### Hướng dẫn sử dụng



**CẢNH BÁO:** Luôn tuân theo các hướng dẫn và quy tắc hiện hành về an toàn.



**CẢNH BÁO:** Để giảm nguy cơ chấn thương cá nhân nghiêm trọng, hãy tắt máy và ngắt kết nối khỏi nguồn điện trước khi thực hiện bất kỳ điều chỉnh nào hoặc tháo/lắp các đồ gá hoặc phụ kiện. Đảm bảo công tắc khởi động ở vị trí OFF. Việc vô tình khởi động có thể gây ra chấn thương.

#### Vị trí tay phù hợp (Hình H)



**CẢNH BÁO:** Để giảm nguy cơ chấn thương cá nhân nghiêm trọng, **LUÔN** để tay ở vị trí phù hợp như hình vẽ.



**CẢNH BÁO:** Để giảm nguy cơ chấn thương cá nhân nghiêm trọng, **LUÔN** giữ chặt tay để tránh trường hợp bị giật lại đột ngột.

Vị trí đặt tay thích hợp yêu cầu một tay đặt trên tay cầm phụ **5** với tay kia trên tay cầm hỗ trợ, như được minh họa trong Hình H.

#### Công Tác Trượt (Hình A)



**THẬN TRỌNG:** Giữ chặt tay cầm chính và thân của công cụ để duy trì khả năng kiểm soát công cụ khi khởi động và trong quá trình sử dụng và cho đến khi bánh xe hoặc phụ kiện ngừng quay. Đảm bảo rằng bánh xe phải dừng hoàn toàn trước khi đặt công cụ xuống.

**LƯU Ý:** Để giảm chuyển động bất ngờ của công cụ, không bật hoặc tắt công cụ trong điều kiện có tải. Để máy chà nhám chạy hết tốc độ trước khi chạm vào bề mặt gia công. Nhấc công cụ khỏi bề mặt trước khi tắt công cụ. Công cụ phải dừng quay trước khi đặt nó xuống.

**!** **CẢNH BÁO:** Trước khi kết nối công cụ với nguồn điện, hãy đảm bảo công tắc trượt phải ở vị trí tắt bằng cách nhấn vào phần sau của công tắc và nhả ra. Đảm bảo công tắc thanh trượt ở vị trí tắt như mô tả ở trên sau khi có bất kỳ sự gián đoạn nào về cung cấp điện cho công cụ, ví dụ như pin hỏng.

Để khởi động công cụ, hãy trượt công tắc trượt BẬT/TẮT 1 về phía trước công cụ. Để dừng công cụ, hãy nhả công tắc trượt BẬT/TẮT.

Để hoạt động liên tục, hãy trượt công tắc về phía trước của công cụ và nhấn phần phía trước của công tắc vào trong. Để dừng công cụ trong khi đang hoạt động ở chế độ liên tục, hãy nhấn phần phía sau của công tắc trượt và nhả ra.

## Khóa trục chính (Hình I)

Khóa trục chính 3 được cung cấp để ngăn không cho trục chính quay trong khi lắp hoặc tháo đĩa. Chỉ bật khóa trục chính khi đã tắt máy, rút phích cắm khỏi nguồn điện, và máy dừng hẳn.

**LƯU Ý:** Để giảm nguy cơ gây hư hỏng cho máy, không bật khóa trục chính khi máy đang vận hành. Máy sẽ bị hỏng và phụ kiện gá có thể văng ra và gây chấn thương.

Để bật khóa, ấn nút khóa trục chính và quay trục chính cho đến khi không thể quay thêm được nữa.

## Mài, Chà Nhám và Chà Bề Mặt Bằng Bàn Chải Sắt

**!** **THẬN TRỌNG:** Luôn sử dụng bộ bảo vệ đúng theo hướng dẫn trong hướng dẫn này.

Để thực hiện công việc trên bề mặt của chi tiết gia công:

1. Cho phép công cụ đạt tốc độ tối đa trước khi chạm công cụ vào bề mặt gia công.
2. Áp dụng áp lực tối thiểu lên bề mặt gia công, cho phép công cụ hoạt động ở tốc độ cao. Tốc độ loại bỏ vật liệu là lớn nhất khi dụng cụ hoạt động ở tốc độ cao.
3. Duy trì một góc thích hợp giữa dụng cụ và bề mặt gia công. Tham khảo biểu đồ theo chức năng cụ thể.

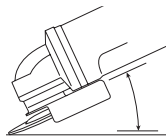

| Chức năng              | Góc     |
|------------------------|---------|
| Mài                    | 20°-30° |
| Chà nhám bằng Đĩa nhám | 5°-10°  |
| Chà nhám bằng Đệm lót  | 5°-15°  |
| Chải bằng Bàn chải sắt | 5°-10°  |

4. Duy trì sự tiếp xúc giữa mép bánh xe và bề mặt làm việc.
  - Nếu mài, chà nhám bằng đĩa gạt hoặc bàn chải sắt, hãy di chuyển liên tục công cụ theo chuyển động tiến và lùi để tránh tạo ra các lỗ hổng trên bề mặt gia công.
  - Nếu chà nhám bằng đệm lót, di chuyển dụng cụ liên tục theo đường thẳng để tránh làm cháy và xoáy bề mặt làm việc.

**LƯU Ý:** Để công cụ nằm yên trên bề mặt gia công mà không di chuyển sẽ làm hỏng chi tiết gia công.

5. Di chuyển công cụ khỏi bề mặt gia công trước khi tắt công cụ. Công cụ phải được dừng quay trước khi đặt nó xuống.

**!** **THẬN TRỌNG:** Cẩn thận hơn khi làm việc trên các cạnh, vì máy mài có thể bị chuyển động mạnh đột ngột.

## Biện Pháp Phòng Ngừa Cẩn Thực Hiện Khi Làm Việc trên Chi Tiết Gia Công Sơn

1. Chà nhám hoặc chà bằng bàn chải sắt sơn gốc chi KHÔNG ĐƯỢC KHUYẾN NGHỊ do khó kiểm soát bụi ô nhiễm. Sự nguy hiểm lớn nhất là nhiễm độc chì ở trẻ em và phụ nữ mang thai.
2. Vì khó xác định liệu sơn có chứa chì hay không nếu không có phân tích hóa học, nên chúng tôi khuyên bạn cần có các biện pháp phòng ngừa sau khi chà nhám bất kỳ loại sơn nào.

### An Toàn Cá Nhân

1. Trẻ em hoặc phụ nữ mang thai không nên vào nơi mà việc chà nhám sơn hoặc chà bằng bàn chải sắt đang được thực hiện cho đến khi hoàn tất việc dọn dẹp.
2. Nên đeo khẩu trang hoặc mặt nạ chống bụi cho tất cả những người vào khu vực làm việc. Bộ lọc nên được thay thế hàng ngày hoặc bất cứ khi nào những người mang nó cảm thấy khó thở.

**LƯU Ý:** Chỉ nên sử dụng những mặt nạ đó chống bụi thích hợp để làm việc với bụi sơn chì và chì. Mặt nạ sơn thông thường không có chức năng bảo vệ này. Tham khảo đại lý hệ thống địa phương của bạn về mặt nạ thích hợp được NIOSH phê duyệt.

3. KHÔNG ĐƯỢC ĂN, UỐNG hoặc HÚT THUỐC trong khu vực làm việc để tránh ăn phải các hạt sơn ô nhiễm. Công nhân phải tắm rửa sạch sẽ TRƯỚC KHI ăn, uống hoặc hút thuốc. Không nên đồ ăn, thức uống, hoặc đồ hút thuốc trong khu vực làm việc, nơi bụi sẽ bám vào.

### An Toàn Môi Trường

1. Nên loại bỏ sơn đúng cách để giảm thiểu lượng bụi phát sinh.
2. Các khu vực thực hiện loại bỏ sơn phải được bịt kín bằng tấm nhựa có độ dày 4 mils.
3. Chà nhám nên được thực hiện theo cách để giảm dòng bụi sơn bên ngoài khu vực làm việc.

### Vệ Sinh Và Thải Bỏ

1. Tất cả các bề mặt trong khu vực làm việc phải được hút bụi và làm sạch kỹ hàng ngày trong suốt thời gian của quá trình chà nhám. Nên thay túi lọc máy hút bụi thường xuyên.
2. Vải vụn nhựa phải được gom lại và xử lý cùng với vụn bụi hoặc mảnh vụn loại bỏ khác. Chúng nên được đặt trong các thùng rác kín khít và xử lý theo quy trình gom rác thông thường.  
Trong quá trình dọn dẹp, trẻ em và phụ nữ có thai cần tránh xa khu vực làm việc ngay.
3. Tất cả đồ chơi, đồ đạc có thể rửa được và đồ dùng mà trẻ sử dụng phải được rửa thật sạch trước khi sử dụng lại.

## Mài và Cắt Cạnh



**CẢNH BÁO:** Không sử dụng bánh xe mài /bánh xe đánh bóng cạnh cho các ứng dụng mài bề mặt vì những bánh xe này không được thiết kế cho áp lực cạnh gấp phải khi mài bề mặt. Bánh xe có thể bị vỡ và gây thương tích.



**THẬN TRỌNG:** Các bánh xe được sử dụng để cắt và mài cạnh có thể bị gãy hoặc văng lại nếu chúng bị uốn cong hoặc xoắn trong khi công cụ đang được sử dụng. Trong tất cả các hoạt động mài/cắt cạnh, mặt hồ của bộ bảo vệ phải được bố trí tránh xa người vận hành.



**LƯU Ý:** Việc mài/cắt cạnh bằng bánh xe Loại 27 phải được giới hạn ở vết cắt và khía nông - độ sâu dưới 13 mm khi bánh xe còn mới. Giảm độ sâu của mức cắt/khía bằng với việc giảm bán kính bánh xe khi bánh xe mài xuống. Tham khảo **Biểu Đồ Phụ Kiện** để biết thêm thông tin. Việc mài/cắt cạnh bằng bánh xe Loại 41 yêu cầu sử dụng tấm chắn bảo vệ Loại 1.

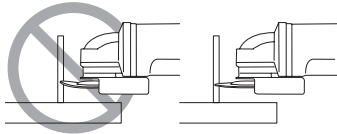

1. Cho phép công cụ đạt tốc độ tối đa trước khi chạm công cụ vào bề mặt gia công.
2. Áp dụng áp lực tối thiểu lên bề mặt gia công, cho phép công cụ hoạt động ở tốc độ cao. Tốc độ mài/cắt là lớn nhất khi dụng cụ hoạt động ở tốc độ cao.
3. Đặt sao cho mặt dưới hồ của bánh xe quay ra xa bạn.
4. Sau khi bắt đầu cắt và có rãnh trên chi tiết gia công, không được thay đổi góc cắt. Việc thay đổi góc sẽ làm cho bánh xe bị cong và có thể gây gãy bánh xe. Bánh mài cạnh không được thiết kế để chịu áp lực cạnh do uốn cong.
5. Di chuyển công cụ khỏi bề mặt gia công trước khi tắt công cụ. Công cụ phải được dừng quay trước khi đặt nó xuống.

## Chà kim loại

Khi sử dụng máy đối với kim loại, nhớ lắp thiết bị ngắt mạch tự động (RCD) để tránh các nguy cơ khác do các mặt kim loại gây ra. Nếu nguồn điện bị ngắt bởi RCD, hãy mang máy đến đại lý sửa chữa được ủy quyền của DeWALT.



**CẢNH BÁO:** Ở các điều kiện làm việc khắc nghiệt, bụi dẫn điện có thể tích tụ bên trong máy khi làm việc với kim loại. Tình trạng này có thể khiến lớp cách điện trong máy bị xuống cấp, gây ra nguy cơ bị điện giật.

Để tránh việc mặt kim loại tích tụ trong máy, hàng ngày người vận hành nên lau sạch các khe thông gió. Xem phần **Bảo trì**.

## Cắt Kim Loại

**Đề cắt mài mòn được gắn, luôn sử dụng bộ bảo vệ loại 1.**

Khi cắt, làm việc với cấp liệu vừa phải, thích nghi dần với vật liệu được cắt. Không tạo áp lực lên đĩa cắt, nghiêng hoặc dao động máy.

Không giảm tốc độ chạy xuống đĩa cắt bằng cách sử dụng áp lực bên.

Máy phải luôn hoạt động trong một chuyển động tăng dần. Nếu không, tồn tại nguy cơ bị đẩy ra không kiểm soát được.

Khi cắt mặt nghiêng và thanh vuông, tốt nhất là bắt đầu ở mặt cắt nhỏ nhất.

## Mài Thô

**Không bao giờ sử dụng đĩa cắt cho gia công thô. Luôn luôn sử dụng bộ bảo vệ loại 27.**

Kết quả gia công thô tốt nhất đạt được khi đặt máy ở góc 30° đến 40°. Di chuyển máy lùi lại với áp lực vừa phải. Bằng cách này, chi tiết gia công sẽ không trở nên quá nóng, không bị biến màu và không hình thành rãnh.

## Đá Cắt

**Máy chỉ được sử dụng để mài cắt khô.**

Đối với đá cắt, tốt nhất là sử dụng đĩa cắt kim cương. Chỉ vận hành máy khi đã đeo mặt nạ chống bụi bổ sung.

## Lời Khuyên Khi Làm Việc

**Thận trọng khi cắt các khe trong tường kết cấu.**

Các khe trong các tường kết cấu phải tuân theo các quy định cụ thể của quốc gia. Các quy định này phải được tuân thủ trong mọi trường hợp. Trước khi bắt đầu sử dụng, hãy tham khảo ý kiến của kỹ sư kết cấu, kiến trúc sư hoặc người giám sát thi công chịu trách nhiệm.

## Bảo trì

Máy điện cầm tay của DeWALT được thiết kế để vận hành trong thời gian dài và ít phải bảo trì nhất. Máy vận hành liên tục theo ý muốn tùy thuộc vào việc bảo quản máy đúng cách và vệ sinh thường xuyên.



**CẢNH BÁO:** Để giảm nguy cơ chấn thương cá nhân nghiêm trọng, hãy tắt máy trước khi thực hiện bất kỳ điều chỉnh nào hoặc tháo/lắp các giá nổi hoặc phụ kiện. Việc vô tình khởi động có thể gây chấn thương.

Không được tự ý bảo trì bộ sạc và pin.



## Tra dầu

Máy điện cầm tay này không cần tra thêm dầu.



## Vệ sinh



**CẢNH BÁO:** Thường xuyên thổi bụi khỏi vỏ máy khi thấy bám bụi xung quanh các khe thông gió. Đeo kính bảo hộ và mặt nạ chống bụi được phê duyệt khi thực hiện quy trình này.



**CẢNH BÁO:** Tuyệt đối không sử dụng các dung môi và hóa chất mạnh để vệ sinh các bộ phận không làm bằng kim loại của máy. Các hóa chất này có thể làm tổn hại đến các nguyên vật liệu sử dụng trong các bộ phận này. Chỉ sử dụng khăn được làm ẩm bằng nước và xà phòng có tính tẩy nhẹ. Tuyệt đối không để chất lỏng lọt vào bên trong máy; không được ngâm các bộ phận của máy vào chất lỏng.

## Phụ kiện tùy chọn



**CẢNH BÁO:** Do các phụ kiện, không phải phụ kiện do DEWALT cung cấp, chưa được kiểm nghiệm với sản phẩm này, nên việc sử dụng các phụ kiện đó với sản phẩm này có thể gây nguy hiểm. Để giảm nguy cơ chấn thương, chỉ được sử dụng các phụ kiện do DEWALT khuyến nghị cho sản phẩm này.

Hỏi ý kiến đại lý để biết thêm thông tin về các phụ kiện phù hợp.

## Bảo vệ môi trường



Thu gom riêng. Không được vứt bỏ sản phẩm và pin có ký hiệu này cùng với rác thải sinh hoạt thông thường.

Sản phẩm và pin chứa vật liệu có thể thu hồi hoặc tái chế giúp giảm nhu cầu về vật liệu thô. Vui lòng tái chế sản phẩm điện và pin theo quy định của địa phương. Thông tin thêm có sẵn tại [www.2helpU.com](http://www.2helpU.com).

## Pin có thể sạc lại











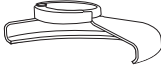

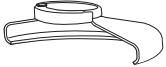
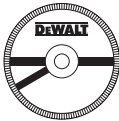



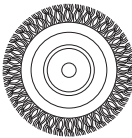

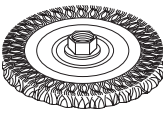
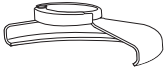
Để pin có tuổi thọ lâu, hãy sạc pin khi pin không tạo đủ điện để thực hiện các tác vụ giống như trước. Nếu tuổi thọ về mặt kỹ thuật của pin đã hết, phải thải bỏ pin cẩn thận để bảo vệ môi trường:

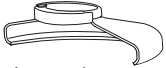
- Xả hết pin, sau đó tháo pin ra khỏi máy.
- Pin Li-Ion là pin có thể tái chế. Hãy mang chúng đến trạm tái chế tại địa phương. Pin được thu gom sẽ được tái chế hoặc thải bỏ đúng cách.



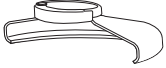



## Sau khi Bảo dưỡng và Sửa chữa

Trung tâm dịch vụ của DEWALT có đội ngũ nhân viên được đào tạo để mang đến cho khách hàng các dịch vụ sản phẩm hiệu quả và đáng tin cậy. Chúng tôi không chịu trách nhiệm nếu bạn sửa chữa ở trung tâm dịch vụ không được ủy quyền. Bạn có thể tham khảo thông tin trên hướng dẫn đi kèm về VỊ TRÍ TRUNG TÂM DỊCH VỤ trong thùng sản phẩm và liên hệ với chúng tôi qua đường dây nóng, trang web hoặc các phương tiện truyền thông xã hội để tìm trung tâm dịch vụ của DEWALT gần bạn nhất.

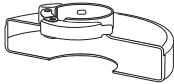
**Biểu Đồ Phụ Kiện**

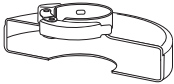
| Loại vành chân  | Phụ kiện   | Mô tả                        | Cách lắp máy mài  |
|---|--|------------------------------|---|
| <br>VÀNH CHÂN LOẠI 27 |   | Đĩa mài lõm tâm              | <br>VÀNH CHÂN LOẠI 27  |
|   |   | Bánh nhám                    | <br>Mặt bích đỡ sau<br><br>  |
|   |   | Bánh xe sắt                  | Đĩa lõm tâm loại 27<br><br>Mặt bích khóa   |
|   |   | Bánh xe sắt có đai ốc ren    | <br>VÀNH CHÂN LOẠI 27<br><br>Bánh xe sắt  |
|   |   | Cốc có nan hoa có đai ốc ren | <br>VÀNH CHÂN LOẠI 27<br><br>Bàn chải sắt  |
|   | <br> | Tám đệm/tám chà nhám         | <br>VÀNH CHÂN LOẠI 27<br><br>Tám đệm cao su<br><br>Đĩa chà nhám<br><br>Đai ốc kẹp |

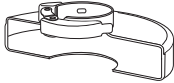
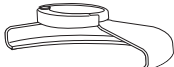
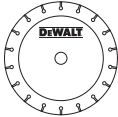
**Biểu Đồ Phụ Kiện (tiếp)**

| Loại vành chắn   | Phụ kiện   | Mô tả                         | Cách lắp máy mài  |
|--|--|-------------------------------|---|
| <br>VÀNH CHẮN LOẠI 1   | <br>Đĩa cắt khối xây,<br>được gắn | Đĩa cắt khối xây,<br>được gắn | <br>VÀNH CHẮN LOẠI 1   |
|  | <br>Đĩa cắt kim loại,<br>được gắn | Đĩa cắt kim loại,<br>được gắn | <br>Mặt bích đệm   |
| <br>VÀNH CHẮN LOẠI 1<br><br>HOẶC LÀ<br><br><br>VÀNH CHẮN LOẠI 27 | <br>Bánh mài cắt đứt<br>kim cương | Bánh mài cắt đứt<br>kim cương | <br>Bánh mài cắt đứt<br><br><br>Mặt bích khóa |

