DEWALT

XR LI-ION

www.DEWALT.com

DCD771
DCD776

English (*original instructions*)

3

中文 (简体)

14

Figure 1

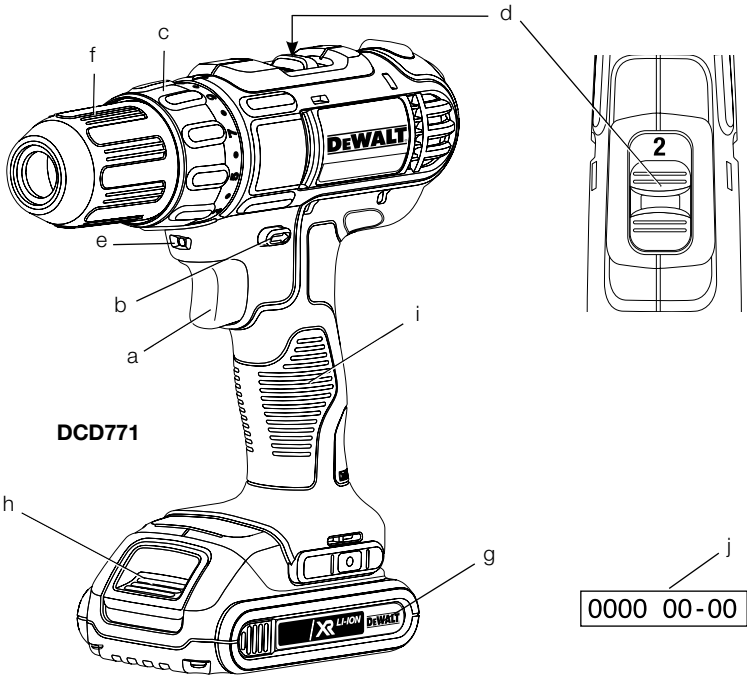

Figure 2

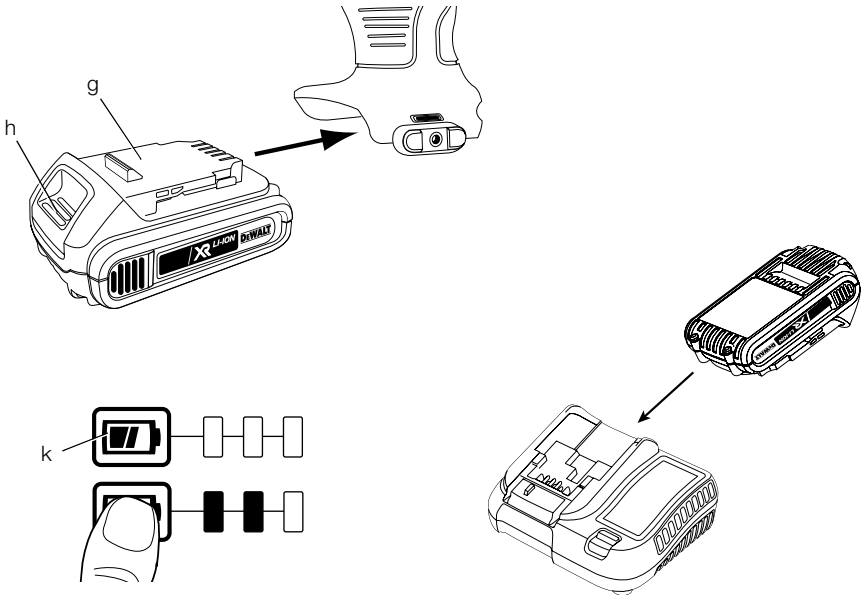

Figure 3

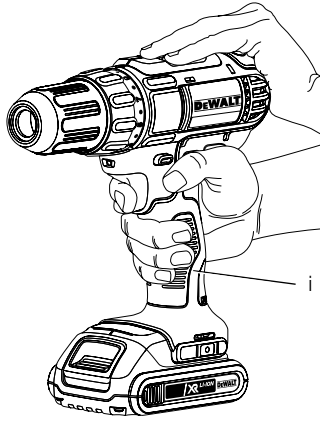

Figure 4

Figure 5

Figure 6

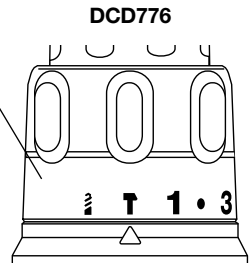
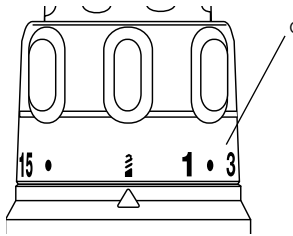
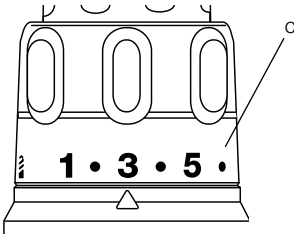
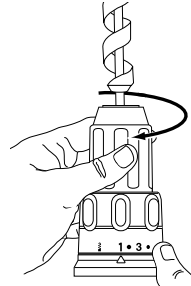
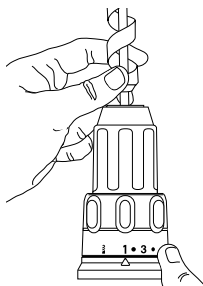
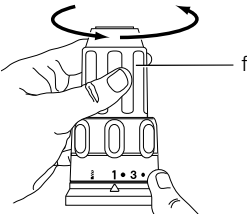

Figure 7

Figure 8

Figure 9



CORDLESS COMPACT 13 mm (1/2") DRILL/DRIVER/ HAMMERDRILL

DCD771, DCD776

Congratulations!

You have chosen a DEWALT tool. Years of experience, thorough product development and innovation make DEWALT one of the most reliable partners for professional power tool users.

Technical Data

		DCD771	DCD776
Voltage	V _{DC}	18(20 Max)	18(20 Max)
Battery Type		Li-Ion	Li-Ion
Power output	W	300	300
No-load speed			
1st gear	min ⁻¹	0–450	0–450
2nd gear	min ⁻¹	0–1500	0–1500
Impact rate			
1st gear	min ⁻¹	–	0–7650
2nd gear	min ⁻¹	–	0–25 500
Max. torque (hard/soft)	Nm	42/24	42/24
Chuck capacity	mm	13	13
Maximum drilling capacity			
Wood	mm	25	25
Metal	mm	13	13
Masonry	mm	–	13
Weight (without battery pack)	kg	1.3	1.34

Batteries				Chargers / Charge Times (Minutes)							
Cat#	V _{DC}	Ah	Weight(kg)	DCB104	DCB107	DCB112	DCB113	DCB115	DCB118	DCB132	DCB119
DCB546/DCB606	18/54 (20/60 Max)	6.0/2.0	1.05	60	270	170	140	90	60	90	X
DCB547/DCB609	18/54 (20/60 Max)	9.0/3.0	1.46	75*	420	270	220	135*	75*	135*	X
DCB548/DCB612	18/54 (20/60 Max)	12.0/4.0	1.44	120	540	350	300	180	120	180	X
DCB181	18 (20 Max)	1.5	0.35	22	70	45	35	22	22	22	45
DCB182/DCB204	18 (20 Max)	4.0	0.61	60/40**	185	120	100	60	60/40**	60	120
DCB183/DCB203	18 (20 Max)	2.0	0.40	30	90	60	50	30	30	30	60
DCB184/DCB205	18 (20 Max)	5.0	0.62	75/50**	240	150	120	75	75/50**	75	150
DCB185	18 (20 Max)	1.3	0.35	22	60	40	30	22	22	22	X
DCB187	18 (20 Max)	3.0	0.54	45	140	90	70	45	45	45	90
DCB189	18 (20 Max)	4.0	0.54	60	185	120	100	60	60	60	120

*Date code 201811475B or later

**Date code 201536 or later

Definitions: Safety Guidelines

The definitions below describe the level of severity for each signal word. Please read the manual and pay attention to these symbols.



DANGER: Indicates an imminently hazardous situation which, if not avoided, will result in **death or serious injury**.



WARNING: Indicates a potentially hazardous situation which, if not avoided, **could** result in **death or serious injury**.



CAUTION: Indicates a potentially hazardous situation which, if not avoided, **may** result in **minor or moderate injury**.

NOTICE: Indicates a practice **not related to personal injury** which, if not avoided, **may** result in **property damage**.



Denotes risk of electric shock.



Denotes risk of fire.



WARNING: To reduce the risk of injury, read the instruction manual.

General Power Tool Safety Warnings



WARNING! Read all safety warnings and all instructions. Failure to follow the warnings and instructions may result in electric shock, fire and/or serious injury.

SAVE ALL WARNINGS AND INSTRUCTIONS FOR FUTURE REFERENCE

The term "power tool" in the warnings refers to your mains-operated (corded) power tool or battery-operated (cordless) power tool.

1) WORK AREA SAFETY

- Keep work area clean and well lit.**
Cluttered or dark areas invite accidents.
- Do not operate power tools in explosive atmospheres, such as in the presence of flammable liquids, gases or dust.** Power tools create sparks which may ignite the dust or fumes.
- Keep children and bystanders away while operating a power tool.** Distractions can cause you to lose control.

2) ELECTRICAL SAFETY

- Power tool plugs must match the outlet. Never modify the plug in any way. Do not use any adapter plugs with earthed (grounded) power tools.** Unmodified plugs and matching outlets will reduce risk of electric shock.
- Avoid body contact with earthed or grounded surfaces such as pipes, radiators, ranges and refrigerators.** There is an increased risk of electric shock if your body is earthed or grounded.
- Do not expose power tools to rain or wet conditions.** Water entering a power tool will increase the risk of electric shock.
- Do not abuse the cord. Never use the cord for carrying, pulling or unplugging the power tool. Keep cord away from heat, oil, sharp edges or moving parts.** Damaged or entangled cords increase the risk of electric shock.
- When operating a power tool outdoors, use an extension cord suitable for outdoor use.** Use of a cord suitable for outdoor use reduces the risk of electric shock.
- If operating a power tool in a damp location is unavoidable, use a residual current device (RCD) protected supply.** Use of an RCD reduces the risk of electric shock.

3) PERSONAL SAFETY

- Stay alert, watch what you are doing and use common sense when operating a power tool. Do not use a power tool while you are tired or under the influence of drugs, alcohol or medication.** A moment of inattention while operating power tools may result in serious personal injury.
- Use personal protective equipment. Always wear eye protection.** Protective equipment such as dust mask, non-skid safety shoes, hard hat, or hearing protection used for appropriate conditions will reduce personal injuries.
- Prevent unintentional starting. Ensure the switch is in the off position before connecting to power source and/or battery pack, picking up or carrying the tool.** Carrying power tools with your finger on the switch or energising power tools that have the switch on invites accidents.
- Remove any adjusting key or wrench before turning the power tool on.** A wrench or a key left attached to a rotating part of the power tool may result in personal injury.

- e) **Do not overreach. Keep proper footing and balance at all times.** This enables better control of the power tool in unexpected situations.
- f) **Dress properly. Do not wear loose clothing or jewellery. Keep your hair, clothing and gloves away from moving parts.** Loose clothes, jewellery or long hair can be caught in moving parts.
- g) **If devices are provided for the connection of dust extraction and collection facilities, ensure these are connected and properly used.** Use of dust collection can reduce dust-related hazards.

4) POWER TOOL USE AND CARE

- a) **Do not force the power tool. Use the correct power tool for your application.** The correct power tool will do the job better and safer at the rate for which it was designed.
- b) **Do not use the power tool if the switch does not turn it on and off.** Any power tool that cannot be controlled with the switch is dangerous and must be repaired.
- c) **Disconnect the plug from the power source and/or the battery pack from the power tool before making any adjustments, changing accessories, or storing power tools.** Such preventive safety measures reduce the risk of starting the power tool accidentally.
- d) **Store idle power tools out of the reach of children and do not allow persons unfamiliar with the power tool or these instructions to operate the power tool.** Power tools are dangerous in the hands of untrained users.
- e) **Maintain power tools. Check for misalignment or binding of moving parts, breakage of parts and any other condition that may affect the power tool's operation. If damaged, have the power tool repaired before use.** Many accidents are caused by poorly maintained power tools.
- f) **Keep cutting tools sharp and clean.** Properly maintained cutting tools with sharp cutting edges are less likely to bind and are easier to control.
- g) **Use the power tool, accessories and tool bits etc., in accordance with these instructions taking into account the working conditions and the work to be performed.** Use of the power tool for operations different from those intended could result in a hazardous situation.

5) BATTERY TOOL USE AND CARE

- a) **Recharge only with the charger specified by the manufacturer.** A charger that is suitable for one type of battery pack may create a risk of fire when used with another battery pack.
- b) **Use power tools only with specifically designated battery packs.** Use of any other battery packs may create a risk of injury and fire.
- c) **When battery pack is not in use, keep it away from other metal objects like paper clips, coins, keys, nails, screws or other small metal objects that can make a connection from one terminal to another.** Shorting the battery terminals together may cause burns or a fire.
- d) **Under abusive conditions, liquid may be ejected from the battery, avoid contact. If contact accidentally occurs, flush with water. If liquid contacts eyes, additionally seek medical help.** Liquid ejected from the battery may cause irritation or burns.

6) SERVICE

- a) **Have your power tool serviced by a qualified repair person using only identical replacement parts.** This will ensure that the safety of the power tool is maintained.

Additional Specific Safety Rules for Drill/Driver/Hammerdrill

- **Wear ear protectors when impact drilling.** Exposure to noise can cause hearing loss.
- **Use auxiliary handle(s), if supplied with the tool.** Loss of control can cause personal injury.
- **Hold power tool by insulated gripping surfaces, when performing an operation where the cutting accessory may contact hidden wiring.** Cutting accessory contacting a "live" wire may make exposed metal parts of the power tool "live" and could give the operator an electric shock.
- **Use clamps or other practical way to secure and support the workpiece to a stable platform.** Holding the work by hand or against your body is unstable and may lead to loss of control.
- **Wear safety goggles or other eye protection.** Hammering and drilling operations cause chips to fly. Flying particles can cause permanent eye damage.

- **Accessories and tool may get hot during operation.** Wear gloves when handling them if performing heat producing applications such as hammerdrilling and drilling metals.
- **Do not operate this tool for long periods of time.** Vibration caused by hammer action may be harmful to your hands and arms. Use gloves to provide extra cushion and limit exposure by taking frequent rest periods.
- **Air vents often cover moving parts and should be avoided.** Loose clothes, jewelry or long hair can be caught in moving parts.

Residual Risks

The following risks are inherent to the use of drills:

- Injuries caused by touching the rotating parts or hot parts of the tool.

In spite of the application of the relevant safety regulations and the implementation of safety devices, certain residual risks cannot be avoided. These are:

- Impairment of hearing.
- Risk of squeezing fingers when changing accessories.
- Health hazards caused by breathing dust developed when working in wood.
- Risk of personal injury due to flying particles.
- Risk of personal injury due to prolonged use.

Markings on Tool

The following pictograms are shown on the tool:



Read instruction manual before use.

DATE CODE POSITION (FIG. 1)

The Date Code (j), which also includes the year of manufacture, is printed into the housing surface that forms the mounting joint between tool and battery.

Example:

2020 XX XX

Year of Manufacture

Important Safety Instructions for All Battery Chargers

SAVE THESE INSTRUCTIONS: This manual contains important safety and operating instructions for the DCB107 battery chargers.

- Before using the charger, read all instructions and cautionary markings on charger, battery pack and product using the battery pack.



WARNING: Shock hazard. Do not allow any liquid to get inside charger. Electric shock may result.



CAUTION: Burn hazard. To reduce the risk of injury, charge only DeWALT rechargeable battery packs. Other types of batteries may overheat and burst resulting in personal injury and property damage.



CAUTION: Children should be supervised to ensure that they do not play with the appliance.

NOTICE: Under certain conditions, with the charger plugged in to the power supply, the exposed charging contacts inside the charger can be shorted by foreign material. Foreign materials of a conductive nature such as, but not limited to, steel wool, aluminum foil or any buildup of metallic particles should be kept away from charger cavities. Always unplug the charger from the power supply when there is no battery pack in the cavity. Unplug charger before attempting to clean.

- **DO NOT attempt to charge the battery pack with any chargers other than the ones in this manual.** The charger and battery pack are specifically designed to work together.
- **These chargers are not intended for any uses other than charging DEWALT rechargeable batteries.** Any other uses may result in risk of fire, electric shock or electrocution.
- **Do not expose charger to rain or snow.**
- **Pull by plug rather than cord when disconnecting charger.** This will reduce risk of damage to electric plug and cord.
- **Make sure that cord is located so that it will not be stepped on, tripped over or otherwise subjected to damage or stress.**
- **Do not use an extension cord unless it is absolutely necessary.** Use of improper extension cord could result in risk of fire, electric shock or electrocution.
- **When operating a charger outdoors, always provide a dry location and use an extension cord suitable for outdoor use.** Use of a cord suitable for outdoor use reduces the risk of electric shock.

- **Do not block the ventilation slots on the charger. The ventilation slots are located on the top and sides of the charger.** Place the charger in a position away from any heat source.
- **Do not operate charger with damaged cord or plug** — have them replaced immediately.
- **Do not operate charger if it has received a sharp blow, been dropped or otherwise damaged in any way.** Take it to an authorised service centre.
- **Do not disassemble the charger; take it to an authorised service centre when service or repair is required.** Incorrect reassembly may result in a risk of electric shock, electrocution or fire.
- In case of damaged power supply cord the supply cord must be replaced immediately by the manufacturer, its service agent or similar qualified person to prevent any hazard.
- **Disconnect the charger from the outlet before attempting any cleaning. This will reduce the risk of electric shock.** Removing the battery pack will not reduce this risk.
- **NEVER attempt to connect 2 chargers together.**
- **The charger is designed to operate on standard 220-240 V household electrical power. Do not attempt to use it on any other voltage.** This does not apply to the vehicular charger.

SAVE THESE INSTRUCTIONS

Chargers

The DCB107 charger accepts 10.8V(12V Max), 18V(20V Max) Li-Ion (DCB121, DCB123, DCB140, DCB141, DCB142, DCB180, DCB181, DCB182, DCB183, DCB185, DCB187, DCB189, DCB203, DCB204 and DCB205) battery packs.

This charger requires no adjustment and is designed to be as easy as possible to operate.

Charging Procedure (fig. 2)







1. Plug the charger into an appropriate 220-240V outlet before inserting the battery pack.
2. Insert the battery pack (g) into the charger, making sure the pack is fully seated in the charger. The red (charging) light will blink continuously indicating that the charging process has started.
3. The completion of charge will be indicated by the red light remaining ON continuously. The

pack is fully charged and may be used at this time or left in the charger.

NOTE: To ensure maximum performance and life of Li-Ion batteries, charge the battery pack fully before first use.

Charging Process

Refer to the table below for the state of charge of the battery pack.

State of charge—DCB107	
 charging	— — — — — 
 fully charged	————— 
 hot/cold pack delay	— — — ————— 

HOT/COLD PACK DELAY (DCB107)

The DCB107 charger has a hot/cold delay feature. When the charger detects a battery that is hot, it automatically delays charging until the battery has cooled.

When the charger detects a battery that is cold, it automatically delays charging until the battery has warmed.

The red light will continue to blink, but a yellow indicator light will be illuminated during this operation. Once the battery has cooled, the yellow light will turn off and the charger will resume the charging procedure.

XR Li-Ion tools are designed with an Electronic Protection System that will protect the battery against overloading, overheating or deep discharge.

The tool will automatically turn off if the Electronic Protection System engages. If this occurs, place the Li-Ion battery on the charger until it is fully charged.

Important Safety Instructions for All Battery Packs

When ordering replacement battery packs, be sure to include the catalog number and voltage.

The battery pack is not fully charged out of the carton. Before using the battery pack and charger, read the safety instructions below and then follow the charging procedures outlined.

READ ALL INSTRUCTIONS

- **Do not charge or use the battery pack in explosive atmospheres, such as in the presence of flammable liquids, gases or dust.** Inserting or removing the battery pack from the charger may ignite the dust or fumes.

- **Never force the battery pack into charger. Do not modify the battery pack in any way to fit into a non-compatible charger as battery pack may rupture causing serious personal injury.**
- Charge the battery packs only in designated DEWALT chargers.
- **DO NOT** splash or immerse in water or other liquids.
- **Do not store or use the tool and battery pack in locations where the temperature may reach or exceed 40 °C (105 °F) (such as outside sheds or metal buildings in summer).**
- For best results, make sure the battery pack is fully charged before use.



WARNING: Never attempt to open the battery pack for any reason. If the battery pack case is cracked or damaged, do not insert it into the charger. Do not crush, drop or damage battery pack. Do not use a battery pack or charger that has received a sharp blow, been dropped, run over or damaged in any way (e.g., pierced with a nail, hit with a hammer, stepped on). Electric shock or electrocution may result. Damaged battery packs should be returned to the service centre for recycling.



CAUTION: When not in use, place tool on its side on a stable surface where it will not cause a tripping or falling hazard. Some tools with large battery packs will stand upright on the battery pack but may be easily knocked over.

SPECIFIC SAFETY INSTRUCTIONS FOR LITHIUM ION (Li-Ion)

- **Do not incinerate the battery pack even if it is severely damaged or is completely worn out.** The battery pack can explode in a fire. Toxic fumes and materials are created when lithium ion battery packs are burned.
- **If battery contents come into contact with the skin, immediately wash the area with mild soap and water.** If the battery liquid gets into the eye, rinse water over the open eye for 15 minutes or until irritation ceases. If medical attention is needed, the battery electrolyte is composed of a mixture of liquid organic carbonates and lithium salts.

- **Contents of opened battery cells may cause respiratory irritation.** Provide fresh air. If symptoms persists, seek medical attention.



WARNING: Burn hazard. Battery liquid may be flammable if exposed to spark or flame.

Battery Pack

BATTERY TYPE

The DCD771 and DCD776 operate on 18 volt battery packs.

The DCB180, DCB181, DCB182, DCB183 or DCB185 battery packs may be used. Refer to

Technical Data for more information.

Storage Recommendations

1. The best storage place is one that is cool and dry away from direct sunlight and excess heat or cold. For optimum battery performance and life, store battery packs at room temperature when not in use.
2. For long storage, it is recommended to store a fully charged battery pack in a cool, dry place out of the charger for optimal results.

NOTE: Battery packs should not be stored completely depleted of charge. The battery pack will need to be recharged before use.

Labels on Charger and Battery Pack

In addition to the pictographs used in this manual, the labels on the charger and the battery pack show the following pictographs:



Read instruction manual before use.



Charging.



Fully charged.



Hot/cold pack delay.



Problem pack or charger.



Problem powerline.



Do not probe with conductive objects.



Do not charge damaged battery packs.



Use only with DeWALT battery packs.
Others may burst, causing personal injury and damage.



Do not expose to water.



Have defective cords replaced immediately.



Charge only between 4 °C and 40 °C.



Discard the battery pack with due care for the environment.



Do not incinerate the battery pack.



Charges Li-ion battery packs.



See **Technical Data** for charging time.



Only for indoor use.

Package Contents

The package contains:

- 1 Drill/driver or 1 drill/driver/hammerdrill
- 1 Charger
- 1 Li-Ion battery pack (C1 model)
- 2 Li-Ion battery packs (C2 model)
- 3 Li-Ion battery packs (C3 model)
- 1 Kitbox
- 1 Instruction manual

NOTE: Battery packs, chargers and kitboxes are not included with N-models.

- *Check for damage to the tool, parts or accessories which may have occurred during transport.*
- *Take the time to thoroughly read and understand this manual prior to operation.*

Description (fig. 1)



WARNING: Never modify the power tool or any part of it. Damage or personal injury could result.

- a. Trigger switch
- b. Forward/reverse control button
- c. Torque adjustment collar
- d. Gear shifter

- e. Worklight
- f. Keyless chuck
- g. Battery pack
- h. Battery release button
- i. Main handle

INTENDED USE

These drills/drivers/hammerdrills are designed for professional drilling, percussion drilling and screwdriving applications.

DO NOT use under wet conditions or in presence of flammable liquids or gases.

These drills/drivers/hammerdrills are professional power tools.

DO NOT let children come into contact with the tool. Supervision is required when inexperienced operators use this tool.

- This product is not intended for use by persons (including children) suffering from diminished physical, sensory or mental abilities; lack of experience, knowledge or skills unless they are supervised by a person responsible for their safety. Children should never be left alone with this product.

Electrical Safety

The electric motor has been designed for one voltage only. Always check that the battery pack voltage corresponds to the voltage on the rating plate. Also make sure that the voltage of your charger corresponds to that of your mains.



Your DeWALT charger is double insulated in accordance with IEC 60335; therefore no earth wire is required.

If the supply cord is damaged, it must be replaced by a specially prepared cord available through the DeWALT service organisation.

Using an Extension Cable

An extension cord should not be used unless absolutely necessary. Use an approved extension cable suitable for the power input of your charger (see **Technical Data**). The minimum conductor size is 1 mm²; the maximum length is 30 m.

When using a cable reel, always unwind the cable completely.

ASSEMBLY AND ADJUSTMENTS



WARNING: To reduce the risk of serious personal injury, turn tool off and disconnect battery pack before making any adjustments or removing/installing attachments or accessories. An accidental start-up can cause injury.



WARNING: Use only DEWALT battery packs and chargers.

Inserting and Removing the Battery Pack from the Tool (fig. 2)



WARNING: Prior to assembly and adjustment, always remove the battery pack. Always switch off the tool before inserting or removing the battery pack.

NOTE: For best results, make sure your battery pack is fully charged.

TO INSTALL THE BATTERY PACK INTO THE TOOL HANDLE

1. Align the battery pack (g) with the rails inside the tool's handle (fig. 2).
2. Slide it into the handle until the battery pack is firmly seated in the tool and ensure that it does not disengage.

TO REMOVE THE BATTERY PACK FROM THE TOOL

1. Press the battery release button (h) and firmly pull the battery pack out of the tool handle.
2. Insert battery pack into the charger as described in the charger section of this manual.

FUEL GAUGE BATTERY PACKS (FIG. 2)

Some DEWALT battery packs include a fuel gauge which consists of three green LED lights that indicate the level of charge remaining in the battery pack.

To actuate the fuel gauge, press and hold the fuel gauge button (k). A combination of the three green LED lights will illuminate designating the level of charge left. When the level of charge in the battery is below the usable limit, the fuel gauge will not illuminate and the battery will need to be recharged.

NOTE: The fuel gauge is only an indication of the charge left on the battery pack. It does not indicate tool functionality and is subject to variation based on product components, temperature and end-user application.

Variable Speed Trigger Switch (fig. 1)

To turn the tool on, squeeze the trigger switch (a). To turn the tool off, release the trigger switch. Your tool is equipped with a brake. The chuck will stop as soon as the trigger switch is fully released.

NOTE: Continuous use in variable speed range is not recommended. It may damage the switch and should be avoided.

Forward/Reverse Control Button (fig. 1)

A forward/reverse control button (b) determines the direction of the tool and also serves as a lock-off button.

To select forward rotation, release the trigger switch and depress the forward/reverse control button on the right side of the tool.

To select reverse, depress the forward/reverse control button on the left side of the tool.

The center position of the control button locks the tool in the off position. When changing the position of the control button, be sure the trigger is released.

NOTE: The first time the tool is run after changing the direction of rotation, you may hear a click on start up. This is normal and does not indicate a problem.

Torque Adjustment Collar (fig. 1)

Your tool has an adjustable torque screwdriver mechanism for driving and removing a wide array of fastener shapes and sizes and in some models, a hammer mechanism for drilling into masonry. Circling the collar (c) are numbers, a drill bit symbol, and on some models, a hammer symbol. These numbers are used to set the clutch to deliver a torque range. The higher the number on the collar, the higher the torque and the larger the fastener which can be driven. To select any of the numbers, rotate until the desired number aligns with the arrow.

Dual Range Gearing (fig. 1)

The dual range feature of your drill/driver/hammerdrill allows you to shift gears for greater versatility.

1. To select speed 1 (high torque setting), turn the tool off and permit it to stop. Slide the gear shifter (d) forward (towards the chuck).
2. To select speed 2 (low torque setting), turn the tool off and permit it to stop. Slide the gear shifter back (away from the chuck).

NOTE: Do not change gears when the tool is running. Always allow the drill to come to a complete stop before changing gears. If you are having trouble changing gears, make sure that the dual range gear shifter is either completely pushed forward or completely pushed back.

Worklight (fig. 1)

There is a worklight (e) located just above the trigger switch (a). The worklight is activated when the trigger switch is depressed. When the trigger is released, the worklight will stay illuminated for up to 20 seconds.

NOTE: The worklight is for lighting the immediate work surface and is not intended to be used as a flashlight.

Keyless Single Sleeve Chuck (fig. 7–9)



WARNING: Do not attempt to tighten drill bits (or any other accessory) by gripping the front part of the chuck and turning the tool on. Damage to the chuck and personal injury may result. Always lock off trigger switch and disconnect tool from power source when changing accessories.



WARNING: Always ensure the bit is secure before starting the tool. A loose bit may eject from tool causing possible personal injury.

Your tool features a keyless chuck (f) with one rotating sleeve for one-handed operation of the chuck. To insert a drill bit or other accessory, follow these steps.

1. Turn tool off and disconnect tool from power source.
2. Grasp the black sleeve of the chuck with one hand and use the other hand to secure the tool. Rotate the sleeve counterclockwise far enough to accept the desired accessory.
3. Insert the accessory about 19 mm (3/4") into the chuck and tighten securely by rotating the chuck sleeve clockwise with one hand while holding the tool with the other. Your tool is equipped with an automatic spindle lock mechanism. This allows you to open and close the chuck with one hand.

Be sure to tighten chuck with one hand on the chuck sleeve and one hand holding the tool for maximum tightness.

To release the accessory, repeat steps 1 and 2 above.

OPERATION

Instructions for Use



WARNING: Always observe the safety instructions and applicable regulations.



WARNING: To reduce the risk of serious personal injury, turn tool off and disconnect battery pack before making any adjustments or removing/installing attachments or accessories. An accidental start-up can cause injury.

Proper Hand Position (fig. 3)



WARNING: To reduce the risk of serious personal injury, ALWAYS use proper hand position as shown.



WARNING: To reduce the risk of serious personal injury, ALWAYS hold securely in anticipation of a sudden reaction.

Proper hand position requires one hand on the top of the drill as shown, with the other hand on the main handle (i).

Screwdriver Operation (fig. 4)

1. Select the desired speed/torque range using the dual range gear selector to match the speed and torque of the planned operation.
2. Turn the torque adjustment collar (c) to the desired position. Lower numbers indicate lower torque settings; higher numbers indicate higher torque settings.
3. Insert the desired fastener accessory into the chuck as you would any drill bit.
4. Make some practice runs in scrap or on unseen areas to determine the proper position of the clutch collar.
5. Always start with lower torque settings, then advance to higher torque settings to avoid damage to the workpiece or fastener.

Drill Operation (fig. 5)



WARNING: To reduce the risk of serious personal injury, turn tool off and disconnect tool from power source before making any adjustments or removing/installing attachments or accessories.



WARNING: To reduce the risk of personal injury, **ALWAYS** ensure workpiece is anchored or clamped firmly. If drilling thin material, use a wood “back-up” block to prevent damage to the material.

1. Turn the collar (c) to the drill symbol.
2. Select the desired speed/torque range using the gear shifter to match the speed and torque to the planned operation.
3. For WOOD, use twist bits, spade bits, power auger bits or hole saws. For METAL, use high-speed steel twist drill bits or hole saws. Use a cutting lubricant when drilling metals. The exceptions are cast iron and brass which should be drilled dry.
4. Always apply pressure in a straight line with the bit. Use enough pressure to keep drill biting, but do not push hard enough to stall the motor or deflect the bit.
5. Hold tool firmly with both hands to control the twisting action of the drill. If model is not equipped with side handle, grip drill with one hand on the handle and one hand on the battery pack.



CAUTION: Drill may stall if overloaded causing a sudden twist. Always expect the stall. Grip the drill firmly to control the twisting action and avoid injury.

6. **IF DRILL STALLS**, it is usually because it is being overloaded or improperly used. **RELEASE TRIGGER IMMEDIATELY**, remove drill bit from work, and determine cause of stalling. **DO NOT CLICK TRIGGER ON AND OFF IN AN ATTEMPT TO START A STALLED DRILL — THIS CAN DAMAGE THE DRILL.**
7. To minimize stalling or breaking through the material, reduce pressure on drill and ease the bit through the last fractional part of the hole.
8. Keep the motor running when pulling the bit back out of a drilled hole. This will help prevent jamming.
9. With variable speed drills there is no need to center punch the point to be drilled. Use a slow speed to start the hole and accelerate by squeezing the trigger harder when the hole is deep enough to drill without the bit skipping out.

Hammerdrill Operation (fig. 6)

DCD776

1. Turn the collar (c) to the hammerdrill symbol.
2. Select the high speed setting by sliding the selector back (away from the chuck).
IMPORTANT: Use carbide-tipped or masonry bits only.
3. Drill with just enough force on the hammer to keep it from bouncing excessively or “rising” off the bit. Too much force will cause slower drilling speeds, overheating and lower drilling rate.
4. Drill straight, keeping the bit at a right angle to the work. Do not exert side pressure on the bit when drilling as this will cause clogging of the bit flutes and a slower drilling speed.
5. When drilling deep holes, if the hammer speed starts to drop off, pull the bit partially out of the hole with tool still running to help clear debris from the hole.

NOTE: A smooth, even flow of dust from the hole indicates proper drilling rate.

MAINTENANCE

Your DEWALT power tool has been designed to operate over a long period of time with a minimum of maintenance. Continuous satisfactory operation depends upon proper tool care and regular cleaning.



WARNING: To reduce the risk of serious personal injury, turn tool off and disconnect battery pack before making any adjustments or removing/installing attachments or accessories. An accidental start-up can cause injury.

The charger and battery pack are not serviceable. There are no serviceable parts inside.



Lubrication

Your power tool requires no additional lubrication.



Cleaning



WARNING: Blow dirt and dust out of the main housing with dry air as often as dirt is seen collecting in and around the air vents. Wear approved eye protection and approved dust mask when performing this procedure.



WARNING: Never use solvents or other harsh chemicals for cleaning the non-metallic parts of the tool. These chemicals may weaken the materials used in these parts. Use a cloth dampened only with water and mild soap. Never let any liquid get inside the tool; never immerse any part of the tool into a liquid.

CHARGER CLEANING INSTRUCTIONS



WARNING: Shock hazard. Disconnect the charger from the AC outlet before cleaning. Dirt and grease may be removed from the exterior of the charger using a cloth or soft non-metallic brush. Do not use water or any cleaning solutions.

Optional Accessories



WARNING: Since accessories, other than those offered by DEWALT, have not been tested with this product, use of such accessories with this tool could be hazardous. To reduce the risk of injury, only DEWALT recommended accessories should be used with this product.

Consult your dealer for further information on the appropriate accessories.

Protecting the Environment



Separate collection. This product must not be disposed of with normal household waste.

Should you find one day that your DEWALT product needs replacement, or if it is of no further use to you, do not dispose of it with household waste. Make this product available for separate collection.



Separate collection of used products and packaging allows materials to be recycled and used again. Re-use of recycled materials helps prevent environmental pollution and reduces the demand for raw materials.

Local regulations may provide for separate collection of electrical products from the household, at municipal waste sites or by the retailer when you purchase a new product.

DEWALT provides a facility for the collection and recycling of DEWALT products once they have reached the end of their working life. To take advantage of this service please return your product

to any authorised repair agent who will collect them on our behalf.

You can check the location of your nearest authorised repair agent by contacting your local DEWALT office at the address indicated in this manual. Alternatively, a list of authorised DEWALT repair agents and full details of our after-sales service and contacts are available on the Internet at: www.2helpU.com.



Rechargeable Battery Pack

This long life battery pack must be recharged when it fails to produce sufficient power on jobs which were easily done before. At the end of its technical life, discard it with due care for our environment:

- Run the battery pack down completely, then remove it from the tool.
- Li-Ion cells are recyclable. Take them to your dealer or a local recycling station. The collected battery packs will be recycled or disposed of properly.

13 毫米 (1/2 英寸) 锂电充电式电钻起子/冲击钻

DCD771、DCD776

恭喜!

感谢您选购 DeWALT 工具。凭借多年的产品开发和创新能力, DeWALT 已经成为专业电动工具用户最可靠的合作伙伴之一。

技术参数

		DCD771	DCD776
电压	伏特	18(20 Max)	18(20 Max)
电池类型		锂离子	锂离子
空载转速			
1 档	转/分	0-450	0-450
2 档	转/分	0-1500	0-1500
冲击率			
1 档	转/分	-	0-7650
2 档	转/分	-	0-25 500
最大扭矩 (硬/软)	牛米	42/24	42/24
夹头尺寸	毫米	13	13
最大钻孔能力			
木材	毫米	25	25
金属	毫米	13	13
砖石	毫米	-	13
重量 (不含电池组)	千克	1.3	1.34

电池				充电器/充电时间(分钟)							
目录号	伏特 _{直流}	安时	重量 (千克)	DCB104	DCB107	DCB112	DCB113	DCB115	DCB118	DCB132	DCB119
DCB546/DCB606	18/54 (最大20/60)	6.0/2.0	1.05	60	270	170	140	90	60	90	X
DCB547/DCB609	18/54 (最大20/60)	9.0/3.0	1.46	75*	420	270	220	135*	75*	135*	X
DCB548/DCB612	18/54 (最大20/60)	12.0/4.0	1.44	120	540	350	300	180	120	180	X
DCB181	18 (最大20)	1.5	0.35	22	70	45	35	22	22	22	45
DCB182/DCB204	18 (最大20)	4.0	0.61	60/40**	185	120	100	60	60/40**	60	120
DCB183/DCB203	18 (最大20)	2.0	0.40	30	90	60	50	30	30	30	60
DCB184/DCB205	18 (最大20)	5.0	0.62	75/50**	240	150	120	75	75/50**	75	150
DCB185	18 (最大20)	1.3	0.35	22	60	40	30	22	22	22	X
DCB187	18 (最大20)	3.0	0.54	45	140	90	70	45	45	45	90
DCB189	18 (最大20)	4.0	0.54	60	185	120	100	60	60	60	120

定义:安全指引

下列定义描述了各警示词的严重程度。请仔细阅读本手册,并注意这些警示符号。



危险:表示存在紧急危险情况,

如果不加以避免,将导致**死亡或严重伤害**。



警告:表示存在潜在的危险情况,如果不加以避免,可能导致**死亡或严重伤害**。



警示:表示存在潜在危险情况,如果不加以避免,可能导致**轻度或中度伤害**。

注意:表示存在**不涉及人身伤害的情况**,如果不加以避免,可能导致**财产损失**。



表示存在**触电风险**。



表示存在**火灾风险**。



警告:为降低伤害风险,请阅读使用手册。

电动工具通用安全警告



警告!阅读所有警告和所有说明。不遵照以下警告和说明会导致电击、着火和/或严重伤害。

保存所有警告和说明书以备查阅。

在所有下列的警告中术语“电动工具”指市电驱动(有线)电动工具或电池驱动(无线)电动工具。

a) 工作场地的安全

- 1) **保持工作场地清洁和明亮。**混乱和黑暗的场所会引发事故。
- 2) **不要在易爆环境,如有易燃液体、气体或粉尘的环境下操作电动工具。**电动工具产生的火花会点燃粉尘或气体。
- 3) **让儿童和旁观者离开后操作电动工具。**注意力不集中会让你失去对工具的控制。

b) 电气安全

- 1) **电动工具插头必须与插座相配。绝不能以任何方式改装插头。需接地的电动工具不能使用任何转换插头。**未经改装的插头和相配的插座将减少电击危险。
- 2) **避免人体接触接地表面,如管道、散热片和冰箱。**如果你身体接地会增加电击危险。
- 3) **不得将电动工具暴露在雨中或潮湿环境中。**水进入电动工具将增加电击危险。
- 4) **不得滥用电线。绝不能用电线搬运、拉动电动工具或拔出其插头。使电线远离热源、油、锐边或运动部件。**受损或缠绕的软线会增加电击危险。
- 5) **当在户外使用电动工具时,使用适合户外使用的外接软线。**适合户外使用的软线将减少电击危险。
- 6) **如果在潮湿环境下操作电动工具是不可避免的,应使用剩余电流动作保护器(RCD)。**使用RCD可减小电击危险。

c) 人身安全

- 1) **保持警觉,当操作电动工具时关注所从事的操作并保持清醒。当你感到疲倦,或在有药物、酒精或治疗反应时,不要操作电动工具。**在操作电动工具时瞬间的疏忽会导致严重人身伤害。
- 2) **使用个人防护装置。始终佩戴护目镜。**安全装置,诸如适当条件下使用防尘面具、防滑安全鞋、安全帽、听力防护等装置能减少人身伤害。
- 3) **防止意外起动。确保开关在连接电源和/或电池组、拿起或搬运工具时处于关断位置。**手指放在已接通电源的开关上或开关处于接通时插入插头可能会导致危险。
- 4) **在电动工具接通之前,拿掉所有调节钥匙或扳手。**遗留在电动工具旋转零件上的扳手或钥匙会导致人身伤害。
- 5) **手不要伸展得太长。时刻注意立足点和身体平衡。**这样在意外情况下能很好地控制电动工具。

- 6) **着装适当。不要穿宽松衣服或佩戴饰品。让你的衣服、手套和头发远离运动部件。**宽松衣服、佩饰或长发可能会卷入运动部件中。
 - 7) **如果提供了与排屑、集尘设备连接用的装置，要确保他们连接完好且使用得当。**使用这些装置可减少尘屑引起的危险。
- d) 电动工具使用和注意事项**
- 1) **不要滥用电动工具，根据用途使用适当的电动工具。**选用适当设计的电动工具会使你工作更有效、更安全。
 - 2) **如果开关不能接通或关断工具电源，则不能使用该电动工具。**不能用开关来控制的电动工具是危险的且必须进行修理。
 - 3) **在进行任何调节、更换附件或贮存电动工具之前，必须从电源上拔掉插头和/或使电池组与工具脱离。**这种防护性措施将减少工具意外起动的危险。
 - 4) **将闲置不用的电动工具贮存在儿童所及范围之外，并且不要让不熟悉电动工具或对这些说明不了解的人操作电动工具。**电动工具在未经培训的用户手中是危险的。
 - 5) **保养电动工具。检查运动件是否调整到位或卡住，检查零件破损情况和影响电动工具运行的其他状况。**如有损坏，电动工具应在使用前修理好。许多事故由维护不良的电动工具引发。
 - 6) **保持切削刀具锋利和清洁。**保养良好的有锋利切削刃的刀具不易卡住而且容易控制。
 - 7) **按照使用说明书，考虑作业条件和进行的作业来使用电动工具、附件和工具的刀头等。**将电动工具用于那些与其用途不符的操作可能会导致危险。
- e) 电池式工具使用和注意事项：**
- 1) **只用制造商规定的充电器充电。**将适用于某种电池组的充电器用到其他电池组时会发生着火危险。
 - 2) **只有在配有专用电池组的情况下才使用电动工具。**使用其他电池组会发生损坏和着火危险。
 - 3) **当电池组不用时，将它远离其他金属物体，例如回形针、硬币、钥匙、钉子、螺钉或其他小金属物体，以防一端与另一端连接。**电池端部短路会引起燃烧或火灾。
 - 4) **在滥用条件下，液体会从电池中溅出，避免接触。如果意外碰到了，用水冲洗。如果液体碰到了眼睛，还要寻求医疗帮助。**从电池中溅出的液体会发生腐蚀或燃烧。
- f) 维修**
- 1) **让专业维修人员使用相同的备件维修电动工具。**这将保证所维修的电动工具的安全。
- ## 电钻起子/冲击钻的附加安全细则
- **使用冲击钻时要戴好耳罩。**暴露在噪声中会引起听力损伤。
 - **使用随工具提供的辅助手柄。**操作失手会引起人身伤害。
 - **当在钻削附件可能触及暗线或其自身软线之处进行操作时，要通过绝缘握持面来握持工具。**钻削附件碰到带电导线会使工具外露的金属零件带电从而使操作者受到电击。
 - **使用夹具或采取其它可行的方法，将工件固定、支撑到稳定的平台上。**手持或用身体顶住工件都是不稳定的，会导致操作失控。
 - **请佩戴安全护目镜或其他护目装备。**冲击或钻孔会导致碎片飞散。飞散的颗粒会对眼睛造成永久性伤害。
 - **附件和工具可能会在使用过程中发热。**如果进行放热应用(如冲击钻孔和金属钻孔)，处理时请佩戴手套。
 - **不要长时间操作此工具。**锤击操作导致的振动可能会伤害您的手部和手臂。使用手套提供额外缓冲，经常停下休息，限制使用时间。
 - **通风口通常会盖住运动部件，应加以避免。**宽松衣服、佩饰或长发可能会卷入运动部件。

剩余风险

使用电钻时具有下列风险：

- 碰触工具的旋转部件或带热的部件会导致人身伤害。

尽管遵守了相关的安全法规并采用了安全装备，某些剩余风险仍然是无法避免的。这些风险包括：

- 听力损伤。
- 更换附件时扭伤手指的风险。
- 锯切木材时，吸入粉尘导致的健康危害。
- 飞溅颗粒造成的人身伤害风险。
- 长时间使用引起的人身伤害风险。

工具上的标记

工具上印有下列标志：



使用前请阅读使用手册。

日期码位置 (图 1)

连接工具和电池之间的机壳表面印有日期代码 (j)，日期代码包括制造年份。

示例：

2020 XX XX

制造年份

针对所有电池充电器的重要安全说明

请妥善保管好这些说明：本手册包含重要的 DCB107 电池充电器安全和操作说明。

- 使用充电器之前，请阅读所有说明和充电器、电池组以及电池组产品上的警示标记。



警告：触电危险。请勿让任何液体渗入充电器，否则会引起触电。



警告：灼伤危险。为了减少受伤的危险，只使用 DeWALT 充电式电池组充电。其他类型的电池可能会过热爆裂，并造成人身伤害和财产损失。



警示：必须监督儿童，确保他们不将此设备当做玩具来玩。

注意：在某些情况下，充电器连接电源时，异物可能会连接充电器内的外露充电接触点而造成短路。请勿让能导电的异物靠近充电器腔，这些异物包括但不限于钢棉、铝箔或任何金属颗粒的堆积物。充电器内没有电池组时，请断开充电器与电源的连接。清洗前，务必拔掉充电器。

- **请勿试图使用本手册指定的充电器以外的任何其他充电器为电池组充电。**充电器和电池组都是专门设计的，互相配合使用。
- **除了为 DeWALT 充电式电池充电以外，这些充电器都不能用于其他任何用途。**否则，可能会导致火灾、触电或电击。
- **请勿将充电器暴露于雨中或雪中。**
- **断开充电器时应拔下插头，切勿拉拽电线。**这将减少电源插头和电源线损坏的风险。
- **确保电源线布置在不易踩踏、踢绊、拉扯或会受到损坏或压力的位置。**
- **非绝对必要条件下禁止使用延长线。**使用延长线不当可能会导致火灾、触电或电击的危险。
- **户外操作充电器时，请务必提供一个干燥的地方，并使用适合户外使用的延长电线。**采用适合户外使用的电线可降低触电风险。
- **禁止堵塞充电器上的通风槽。通风槽位于充电器的顶部和两侧。**请把充电器放置在远离任何热源的地方。
- **禁止使用电源线或插头已损坏的充电器 - 请立即更换已损坏的充电器。**
- **如果充电器受到强烈重击、掉落或出现其他损坏情况，请不要使用充电器。**请将损坏的充电器送到授权维修中心维修。
- **请勿拆卸充电器，请将需要维修或修理的充电器送到授权维修中心。**重装不正确可能会导致触电、电击或火灾风险。

- 必须立即将已损坏的电源线交由制造商、服务代理或类似的合格人员进行更换以防止安全隐患。
- **清洁前, 请先断开充电器和插座的连接, 以降低触电风险。**取出电池组不会降低触电风险。
- **切勿**试图将两个充电器连接在一起。
- **充电器额定电压是标准 220 伏家用电压。请勿试图在任何其他电压下使用充电器。此规则不适用于车载充电器。**

请妥善保管好这些说明

充电器

DCB107 充电器适用于 10.8 伏(最大 12 伏) 伏、18 伏(最大 20 伏) 伏锂离子 (DCB121、DCB123、DCB140、DCB141、DCB142、DCB180、DCB181、DCB182、DCB183 和 DCB185) 电池组。

此充电器专为简易操作而设计, 因此无需做出任何调整。







充电程序 (图 2)

1. 插入电池组前请将充电器插入到相应的 220-240 伏插座。
2. 将电池组 (g) 插入到充电器中, 确定电池组完全就位。红色 (充电中) 指示灯将不断闪烁, 表示充电过程已经开始。
3. 红色灯持续亮起表示充电完成。此时电池组已完全充电, 您可以使用电池组或将电池组留在充电器上。

注: 为了确保锂离子电池的效能和使用寿命最大化, 在首次使用电池组之前必须将其完全充电。

充电过程

关于电池组的充电状态, 请参阅下表。

充电状态 - DCB107	
 充电中	--- -- -- -- -- 
 已完全充电	----- 
 热/冷电池组延迟	--- -- -- -- -- ----- 

热/冷电池组延迟 (DCB107)

DCB107 充电器具有热/冷延迟功能。当充电器检测到电池为热的时, 它会自动延迟充电, 直到电池冷却下来为止。

当充电器检测到电池为冷的时, 它会自动延迟充电, 直到电池稍变热为止。

红色指示灯会继续闪烁, 但黄色指示灯在本次操作过程中会亮起。电池冷却后, 黄色指示灯会熄灭, 充电器将恢复充电程序。

XR 锂离子电池工具具有“电子保护系统”设计, 可保护电池免受过载、过热或过度放电之害。

如果电子保护系统处于运作状态, 该工具将自动停止操作。如果发生这种情况, 请将锂离子电池放在充电器上直到完全充电。

针对所有电池组的重要安全说明

在订购更换电池组时, 请务必附上目录号码和电压。包装箱内的电池组并未完全充电。在使用电池组和充电器之前, 请阅读下面的安全说明, 然后按照所述充电程序进行操作。

请阅读所有说明

- **请勿在易爆环境中充电或使用电池组, 如有易燃液体、气体或粉尘的环境。**在充电器中插入或取出电池组时可能会点燃粉尘或烟雾。
- **切勿将电池组强行插入充电器。不得以任何方式改装电池组并将电池组插入不兼容的充电器, 这种操作可能会导致电池组破裂, 并造成严重的人身伤害。**
- 只使用指定的 DeWALT 充电器为电池组充电。
- **请勿**喷溅电池组或将其浸泡在水或其他液体中。
- **禁止在温度可能达到或超过 40 °C (105 °F) 的地方 (如夏天户外的棚子或金属建筑物中) 存储或使用工具和电池组。**
- 为达到最佳效果, 请确保电池组在使用前已完全充电。



警告: 切勿以任何理由试图打开电池组。电池组外壳破裂或损坏时, 不要将电池

组插入充电器。不要挤压、掉落或损坏电池组。不要使用受过强烈重击、掉落、碾压或以任何其他方式(如被钉子穿破、受到锤子的重击、踩踏)受损的电池组或充电器,否则可能会引起触电或电击。损坏的电池组应交回服务中心进行回收。



警告:不用时,将工具侧放在平稳的表面上,确保不会有踢绊或掉落的危险。一些具有大型电池组的工具将直立于电池组之上,但可能会轻易被撞倒。

锂离子电池的安全说明

- **即使电池组已经严重受损或已完全耗竭也不可焚烧处理电池组。**电池组会在火中会发生爆炸。锂离子电池在燃烧时会释放有毒气体和物质。
- **如果皮肤接触到电池内含物质,请立即用温和肥皂和水冲洗接触的地方。**如果电池液进入眼睛,应睁开眼睛用清水冲洗至少 15 分钟或直到刺激感消失。
如果需要医疗救助,请告知医护人员。电池电解质是由液状有机碳酸盐和锂盐的混合物组成。
- **已打开电池的內部物质可能会导致呼吸道刺激。**请保持空气流通。如果症状持续存在,请寻求医疗帮助。



警告:灼伤危险。电池液如果接触到火花或火焰就有可能燃烧。

电池组

电池类型

DCD771 和 DCD776 使用 18 (最大20)伏特电池组。

DCB180、DCB181、DCB182、DCB183、DCB185、DCB187、DCB189、DCB203、DCB204或 DCB205 的电池组也可以使用。更多信息,请参阅**技术参数**。

存放建议

1. 最好将电池存放在阴凉、干燥、远离阳光直射、不会过热或过冷的地方。为了获得最佳的电池性能和使用寿命,请您在不使用电池组时将其存储在室温下。

2. 长期存储时,建议将完全充电的电池组从充电器取出,存储在阴凉、干燥的地方,以达到最佳效果。

注:电池组不应在电池已完全耗尽的状态下存放。使用电池组之前,必须重新为电池组充电。

充电器和电池组上的标签

除了在本手册中所使用的标志,充电器和电池组的标签还包括:



使用前请阅读使用手册。



充电中。



已完全充电。



热/冷电池组延迟。



电池组或充电器故障。



电源线故障。



请勿使用导电物体碰触。



请勿对已损坏的电池组充电。



只使用 DeWALT 电池组。其他电池组可能会爆炸,导致人身伤害和损坏。



请勿将其暴露于水中。



电线故障,请立即更换。



只在温度介于 4 °C 至 40 °C 之间充电。



弃置电池组时,请妥善处理以保护我们的环境。

LI-ION



请勿焚烧电池组。



锂离子电池组充电。



有关充电时间, 请参阅 **技术参数**。



只能在室内使用。

包装内的物品

本产品包装内的物品有：

- 1 电钻/起子或 1 个电钻/起子/冲击钻
- 1 充电器
- 1 锂离子电池组 (C1 型号)
- 2 锂离子电池组 (C2 型号)
- 3 锂离子电池组 (C3 型号)
- 1 工具箱
- 1 使用手册

注: N 型号不包括电池组、充电器和工具箱。

- 检查工具、部件或附件是否在运输过程中损坏。
- 操作前, 请抽空仔细阅读并掌握本手册。

描述 (图 1)



警告: 切勿改装电动工具或其任何部件, 否则可能会导致损坏或人身伤害。

- a. 触发开关
- b. 正转/反转控制按钮
- c. 扭矩调节轴环
- d. 换档器
- e. 工作灯
- f. 自紧式夹头
- g. 电池组

h. 电池释放按钮

i. 主手柄

设计用途

这些电钻/起子/冲击钻设计用于专业钻孔、冲击钻孔和螺丝安装。

请勿在潮湿环境中或在有易燃液体或气体的环境中使用。

这些电钻/起子/冲击钻是专业型电动工具。

请勿让儿童接触本工具。缺乏经验的操作员需要在监督下使用本工具。

- 本产品不适合体力、感官或智力不足以及缺乏经验、知识或技能的人员 (包括儿童) 使用, 除非一旁有能为他们的安全负责的监督人员。不得在无人监管的情况下让儿童触及本产品。

电气安全

电机只适用一种工作电压。请务必检查电池组的电压是否和铭牌上的电压一致。另外, 请确保充电器电压和主电源的电压一致。



您的 DeWALT 充电器符合 IEC 60335 双重绝缘要求, 因此无需使用接地线。

若电源线损坏, 必须交由 DeWALT 服务部门采用专门制备的电线进行更换。

使用延长电缆

除非绝对必要, 否则请勿使用延长线。使用适合您的充电器电源输入的合格延长线 (见 **技术参数**)。最小的导线尺寸为 1 mm²; 最大长度为 30 m。

使用电缆卷筒时, 请务必拉出所有的电缆。

组装和调整



警告: 为降低严重的人身伤害风险, 在进行任何调整或取出/安装附加装置或附件之前, 请关闭工具并断开电池组连接。意外启动可能会导致人身伤害。



警告: 只使用 DeWALT 电池组和充电器。

插入和取出 工具上的电池组 (图 2)



警告: 组装与调整之前, 请务必取出电池组。插入或取出电池组之前, 请务必关闭工具。

注: 为达到最佳效果, 请确保电池组在使用前完全充电。

将电池组安装到工具手柄中

1. 将电池组 (g) 对齐工具手柄内的轨道 (图 2)。
2. 将电池组滑入手柄内, 使其牢牢地固定在工具内, 并确保不会脱离。

从工具中取出电池组

1. 按电池释放按钮 (h), 并用力将电池组从工具手柄中拉出。
2. 按本手册充电器部分所述将电池组插入充电器中。

电池组电量计 (图 2)

一些 DeWALT 电池组带有一个包含三个绿色 LED 指示灯的电量计, 用于指示电池组内的剩余电量。

若要启动电量计, 请按下电量计按钮 (k) 不要松开。三个绿色 LED 指示灯将以组合方式亮起, 以指示剩余电量。当电池内的电量低于可用限制时, 电量计将不会亮起, 电池将需要重新充电。

注: 电量计仅指示电池组的剩余电量。它并不表示该工具的功能性能, 且将根据产品组件、温度和最终用户的使用情况而有所不同。

变速触发开关 (图 1)

若要开启工具, 请按压触发开关 (a)。若要关闭工具, 请松开触发开关。您的工具配备制动器。触发开关完全松开时夹头将停止运作。

注: 不建议在变速范围内连续使用工具。否则可能会损坏开关, 因此应尽量避免。

正转/反转控制按钮 (图 1)

正转/反转控制按钮 (b) 可确定工具方向, 同时具有锁定按钮的功能。

若要选择正向旋转, 请松开触发开关, 然后按下工具右侧的正转/反转控制按钮。

若要选择反向旋转, 请按下工具左侧的正转/反转控制按钮。

控制按钮的中心位置会将工具锁定在关闭位置。改变控制按钮的位置时, 确保触发开关处于松开状态。

注: 改变旋转方向后第一次运行工具时, 您可能会在启动时听到“咔哒声”。这是正常现象, 并不表示出现问题。

扭矩调节轴环 (图 1)

您的工具配备一个可调节的扭矩螺丝起子装置, 用于安装和取出各种形状和大小的紧固件, 而且在某些型号中还配备一个锤击装置, 用于砖石钻孔。轴环 (c) 的周围是编号和钻头符号, 在某些型号中, 还有冲击钻符号。这些编号用于设置离合器以提供扭矩范围。轴环上的编号越大, 扭矩越高, 并且可安装的紧固件也越大。若要选择任一编号, 请旋转轴环直到所需的编号与箭头对齐。

双速排挡 (图 1)

电钻/起子/冲击钻的双速功能可换挡以获得更大的适用性。

1. 若要选择速度 1 (高扭矩设置), 请关闭工具并让它停止转动。将换挡器 (d) 尽量向前滑动 (滑向夹头)。
2. 若要选择速度 2 (低扭矩设置), 请关闭工具并让它停止转动。将换挡器尽量向后滑动 (远离夹头)。

注: 工具在运行时切勿换挡。在换挡之前, 务必等待电钻完全停止。如果无法换挡, 请确保双速换挡器已完全向前推动或完全向后推动。

工作灯 (图 1)

工作灯 (e) 位于触发开关 (a) 正上方。工作灯将在按压触发开关时启动。松开触发开关后, 工作灯最长将延迟 20 秒。

注: 工作灯是用于照亮紧邻的工作表面, 不能当作手电筒使用。

无钥匙式夹头(图 7-9)



警告:请勿试图通过握住夹头前端和打开工具来拧紧钻头(或任何其他附件)。这可能会导致夹头损坏和人身伤害。更换附件时,始终锁定触发开关并断开工具的电源连接。



警告:启动工具之前应确保钻头安装稳固。松动的钻头可能会从工具脱落,从而可能导致人身伤害。

您的工具配备自紧式夹头(f),带有一个旋转套管,便于单手操作夹头。若要插入钻头或其他附件,请执行下列步骤。

1. 关闭工具并断开工具的电源连接。
2. 用一只手抓住夹头的黑色套管,用另一只手固定工具。逆时针旋转套管以接受所需的附件。
3. 将附件插入夹头约 19 毫米(3/4")处,然后用一只手顺时针旋转夹头,另一只手则握住工具,将附件拧紧。您的工具配备一个自动主轴锁装置。凭借此装置,您只需一只手即可打开和关闭夹头。

确保在拧紧夹头时用一只手握住夹头套管,用另一只手握住工具,以获得最大的紧密性。

若要松开附件,请重复上述步骤 1 和 2。

操作

使用说明



警告:请务必遵守安全指示和适用法规。



警告:为降低严重的人身伤害风险,在进行任何调整或取出/安装附加装置或附件之前,请关闭工具并断开电池组连接。意外启动可能会导致人身伤害。

正确的手持方式(图 3)



警告:为降低严重的人身伤害风险,请务必使用正确的手持方式,如图所示。



警告:为降低严重的人身伤害风险,请务必紧握工具以防止意外事件。

正确的手持方式要求一只手握住电钻顶端(如图所示),另一只手则握住主手柄(i)。

螺丝起子操作(图 4)

1. 使用双速档位选择器选择所需的速度/扭矩范围以满足操作计划的速度和扭矩要求。
2. 将扭矩调节轴环(c)转至所需位置。编号越小,表示扭矩设置值越小;编号越大,表示扭矩设置值越大。
3. 将所需的紧固件附件插入任意钻头的夹头。
4. 在较小或隐蔽区域进行一些实际运行以确定夹头轴环的正确位置。
5. 务必先从较低的扭矩设置开始,然后再使用较高的扭矩设置以避免损坏工件或紧固件。

电钻操作(图 5)



警告:为降低严重的人身伤害风险,在进行任何调整或取出/安装附加装置或附件之前,请关闭工具并断开工具电源连接。



警告:为降低人身伤害风险,请始终牢固锚定或夹紧工件。如果在较薄材料上钻孔,请使用“垫板”以防止损坏材料。

1. 将轴环(c)转至电钻符号。
2. 使用换档器选择所需的速度/扭矩范围以满足操作计划的速度和扭矩要求。
3. 钻木材时,应使用麻花钻头、扁钻头、机械螺旋钻头或孔锯。钻金属时,应使用高速钢麻花钻头或孔锯。在金属上钻孔时,请使用切削润滑剂。但铸铁和黄铜材料例外,应干钻。
4. 用力方向始终与钻头成一直线。请施加足够大的压力,保证钻进所需,但不要大到马达失速或钻头倾斜。
5. 请双手紧握电钻,控制电钻的扭转效应。如果该型号不带侧手柄,请用一只手抓紧电钻手柄,另一只手则抓住电池组。



警告:如果过载,电钻可能会失速,从而导致突然扭转。务必预计是否会发生失速。紧握电钻以控制扭转效应,避免伤害。

6. **如果电钻失速**,通常是由于过载或使用不当所致。**请立即松开触发开关**,从工件上退出钻头,查找失速的原因。**切勿试图通过按下、松开触发开关来启动失速的电钻 - 这会损坏电钻。**
7. 为尽量减少失速故障或避免钻头在材料中折断,请降低对电钻的压力,使钻头从孔的最后部分中缓和下来。
8. 从成孔中拉出钻头时,请保持马达运转。这有助于防止卡死。
9. 使用变速电钻时,无需中心冲定位。启动时采用较低速度,当钻深足以防止跳钻时,加力挤压触发开关,使电钻加速。



警告:为降低严重的人身伤害风险,在进行任何调整或取出/安装附加装置或附件之前,请关闭工具并断开电池组连接。意外启动可能会导致人身伤害。

充电器和电池组无法维修。这些组件内没有可以维修的部件。



润滑

本电动工具无需另行润滑。



清洁



警告:一旦通风口和周围积聚了可见的粉尘,请立即用干燥的空气吹走主机外壳内的粉尘和灰尘。执行此过程时,需戴上经认可的护目装备和防尘面具。



警告:切勿使用溶剂或其他刺激性化学制品来清洁工具的非金属部件。这些化学物质可能会削弱这些部件使用的材料。请用布蘸温和的肥皂水擦拭。切勿让任何液体渗入工具,切勿让工具的任何部分浸在液体中。

充电器清洁说明



警告:触电危险。清洁前,请将充电器从交流电源插座上拔下。可用布或非金属软刷清除充电器外部的污垢和油脂。请勿使用水或任何清洁剂。

可选附件



警告:由于非 DEWALT 供应的附件未经本产品匹配测试,将此类附件用于本工具可能会造成危险。为降低伤害风险,本产品只可使用 DEWALT 推荐的附件。

请向您的经销商咨询更多关于合适附件的信息。

冲击钻操作 (图 6)

DCD776

1. 将轴环 (c) 转至电钻符号。
2. 向后滑动选择器 (远离夹头), 选择高速设置。

重要信息:只使用碳化钻头或砖石钻头。

3. 钻孔时,只需对锤子施加足够的力,以防止过度反弹或“脱离”钻头。过多压力将导致钻孔速度变慢,过热,钻孔速度降低。
4. 直线钻孔,保持钻头与工件成直角。钻孔时不要在钻头上施加侧压力,这将导致钻头凹槽阻塞和钻孔速度变慢。
5. 钻深孔时,如果锤子速度开始减慢,在工具仍运行的情况下,从孔中拔出部分钻头以帮助清理钻屑。

注:如果钻屑平滑、均匀地流出,则表明钻孔速度适当。

维护

DEWALT 电动工具设计精良,可以长期使用,而且只需最少的维护。要连续获得令人满意的工作效果,需要进行合适的工具维护和定期清洁。

保护环境



分类回收。本产品不得与普通家庭垃圾一起处理。

如果您发现您的 DeWALT 产品需要更换或您已经不再需要使用这些产品，请不要将它们与家庭垃圾一起处理。请将它们单独分类回收。



分类回收使用过的产品和包装能够让材料得以再循环和再利用。回收材料的再利用有助于防止环境污染，并降低对原材料的需求。

当地法规可能要求由市政废物处理点或向您出售新产品的零售商提供从家庭中分类回收电气产品的服务。

DeWALT 提供设施收集和回收使用寿命到期的 DeWALT 产品。若要享受这项服务，请将产品送回任一授权维修代理，他们将代表我们回收您的产品。

您可通过联系本手册中所记载的当地 DeWALT 办事处查询离您最近的授权维修代理的位置。您也可以通过网络获取 DeWALT 授权维修代理名单以及我们售后服务与联络人的完整详情，网址为：www.2helpU.com。



充电式电池组

本电池组使用寿命长，不能提供顺利完成工作所需的电力时，必须进行充电。电池技术寿命结束时，请妥善处理以保护我们的环境。

- 耗尽电池组的电力，然后从工具上拆下。

- 锂离子电池是可回收的。将它们送往您的经销商处或当地的回收站。回收的电池组将被妥善循环使用或处理。

制造商： 百得德国公司

地址： Black & Decker Str.40 65510 Idstein, 德国

产地： 江苏苏州

