

INSTRUCTION MANUAL

DEWALT®

DWV902M-XE
HEAVY-DUTY DUST EXTRACTOR VACUUM



Definitions: Safety Guidelines

The definitions below describe the level of severity for each signal word. Please read the manual and pay attention to these symbols.

⚠DANGER: Indicates an imminently hazardous situation which, if not avoided, **will** result in **death or serious injury**.

⚠WARNING: Indicates a potentially hazardous situation which, if not avoided, **could** result in **death or serious injury**.

⚠CAUTION: Indicates a potentially hazardous situation which, if not avoided, **may** result in **minor or moderate injury**.

NOTICE: Indicates a practice **not related to personal injury** which, if not avoided, **may** result in **property damage**.

IF YOU HAVE ANY QUESTIONS OR COMMENTS ABOUT THIS OR ANY DEWALT TOOL, CALL US AT: **1800 444 224** (Aust) or **0800 339 258** (NZ).

Technical Data

DWV902M		
Voltage	V	230
Rated power	W	1400
Max power	W	2400
Power, normal operation (EN 60335-2-69)	W	1200
Frequency	Hz	50
Protective class		IPX4
Container capacity	l	38
Filling quantity (liquid)	l	18.4
Flow rate (max)	l/s	31.1
Negative pressure (max)	kPa (mbar)	15.5
Filter surface	m ²	0.4

Power connection data of power tool	W	1000
Hose length	m	4.6
Hose diameter	mm	32
Weight	kg	15
<hr/>		
L _{PA} (sound pressure)	dB(A)	73
K _{PA} (sound pressure uncertainty)	dB(A)	3
L _{WA} (sound power)	dB(A)	87
K _{WA} (sound power uncertainty)	dB(A)	3

SAFETY INSTRUCTIONS FOR POWER TOOLS

When using power tools, always observe the safety regulations applicable in your country to reduce the risk of fire, electric shock and personal injury. Read the following safety instructions before attempting to operate this product. Keep these instructions in a safe place.



WARNING: To reduce the risk of injury, user must read the instruction manual.

Important Safety Instructions



WARNING! Read all safety warnings and all instructions Failure to follow the warnings and instructions may result in electric shock, fire and/or serious injury.

SAVE ALL WARNINGS AND INSTRUCTIONS FOR FUTURE REFERENCE

BEFORE USING THIS APPLIANCE, READ AND FOLLOW ALL INSTRUCTIONS.

⚠WARNING: To reduce the risk of electric shock. Do not expose to rain. Store indoors.

- Do not leave the appliance when it is connected to a power source. Unplug it from outlet when not in use and before servicing.
- Do not allow the appliance to be used as a toy. Pay close attention when the appliance is used by or near children.

- Use this appliance ONLY as described in the manual. Use only DEWALT recommended attachments.
- Do not use this appliance with a damaged cord or plug. If the appliance is not working correctly, or if it has been dropped, damaged, left outdoors, or dropped in water, return it to a service center.
- Do not pull or carry this appliance by the cord, use the cord as a handle, close a door on the cord, or pull the cord around sharp edges or corners. Do not run the appliance over the cord. Keep cord away from heated surfaces.
- Do not unplug this appliance by pulling on the cord. To unplug, grasp the plug, not the cord.
- Do not handle the plug or appliance with wet hands.
- Do not put any objects into the openings of the appliance. Do not use the appliance with any opening blocked; keep free of dust, lint, hair and anything else that may reduce air flow.
- Keep hair, loose clothing, fingers, and all body parts away from the openings and moving parts.
- Turn off all controls before unplugging appliance.
- Use extra care when cleaning on stairs.
- Do not use the appliance to pick up flammable or combustible liquids, such as gasoline, or use in areas where flammable or combustible liquids are present.
- Static shocks are possible in dry areas or when the relative humidity of the air is low. This is only temporary and does not affect the use of the vacuum. To reduce the frequency of static shocks, add moisture to the air with a console, installed humidifier or use DWV9316 non-static hose accessory.
- To avoid spontaneous combustion, empty canister after each use.

Electrical Safety

The electric motor has been designed for one voltage range only. Always check that the power supply corresponds to the voltage on the rating plate. 220–240 V AC means your appliance will operate on alternating current. Operation at a voltage outside this range can cause loss of power and can result in overheating. All DEWALT appliances are factory tested; if this appliance does not operate, check the power supply. Your DEWALT appliance is double insulated, therefore no earth wire is required.

- **Young children and the infirm.** This appliance is not intended for use by young children or infirm persons without supervision.
 - This appliance is not intended for use by persons (including children) with reduced physical, sensory or mental capabilities, or lack of experience and knowledge, unless they have been given supervision or instruction concerning use of the appliance by a person responsible for their safety.
 - Children should be supervised to ensure that they do not play with the appliance.
- **Replacement of the supply cord.** If the supply cord or plug is damaged, it must be replaced by the manufacturer or an authorised DEWALT Service Centre in order to avoid a hazard.

Grounding Instructions

This appliance must be grounded. If it should malfunction or breakdown, grounding provides a path of least resistance for electric current to reduce the risk of electric shock. This appliance is equipped with a cord having an equipment-grounding conductor and grounding plug. The plug must be inserted into an appropriate outlet that is properly installed and grounded in accordance with all local codes and ordinances.

⚠WARNING: Improper connection of the equipment-grounding conductor can result in a risk of electric shock. Check with a qualified electrician or service person if you are in doubt as to whether the outlet is properly grounded. Do not modify the plug provided with the appliance – if it will not fit the outlet, have a proper outlet installed by a qualified electrician.

This appliance is for use on a nominal 230-volt circuit and has a grounding attachment plug that looks like the plug illustrated in Figure A. Make sure that the appliance is connected to an outlet having the same configuration as the plug. No adaptor should be used with this appliance.

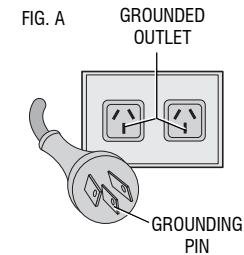

Extension Cords

⚠ CAUTION: Use only extension cords that are approved by the country's Electrical Authority. Before using extension cords, inspect them for loose or exposed wires, damaged insulation and defective fittings. Replace the cord if necessary.

Additional Safety Warnings

- Do not pick up anything that is burning or smoking, such as cigarettes, matches, or hot ashes.
- Do not use to vacuum combustible explosive materials, such as coal, grain, or other finely divided combustible material.
- Do not use to vacuum hazardous, toxic or carcinogenic materials, such as asbestos or pesticide.
- Never pick up explosive liquids (e.g. gasoline, diesel fuel, heating oil, paint thinner, etc.), acids or solvents.
- Do not use vacuum without filters in place, except as described under **Wet Pickup Applications**.
- Some wood contains preservatives which can be toxic. Take extra care to prevent inhalation and skin contact when working with these materials. Request and follow any safety information available from your material supplier.
- Do not use vacuum as a step ladder.
- Do not place heavy objects on vacuum.

⚠ WARNING: We recommend the use of a residual current device with a residual current rating of 30mA or less.

SAVE ALL WARNINGS AND INSTRUCTIONS FOR FUTURE REFERENCE

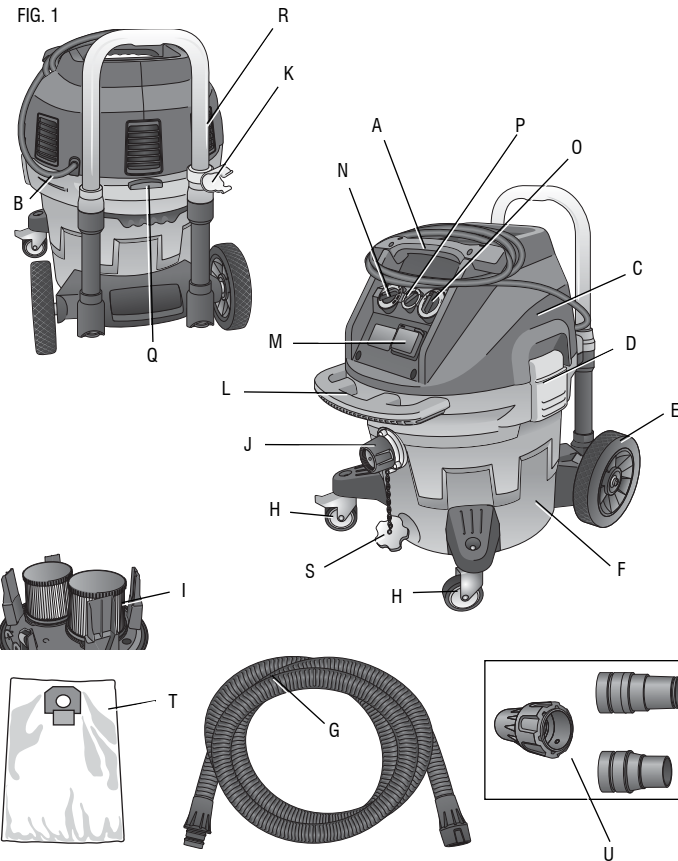

COMPONENTS (Fig. 1)

⚠ WARNING: Never modify the power tool or any part of it. Damage or personal injury could result.

A. Top handle/cord wrap	K. Hose clip
B. Power cord	L. Front handle
C. Vacuum head	M. Outlet for power tools
D. Canister latch	N. Variable suction dial
E. Wheel	O. On/off/tool control switch
F. Canister	P. Flow alarm adjustment
G. Suction hose	Q. Telescoping handle release button
H. Casters (one equipped with parking brake)	R. Telescoping handle
I. Filters	S. Inlet plug
J. Twist-lock hose inlet	T. Bag
	U. DWV9210-XJ connector kit (includes DWV9000, DWV9120, DWV9130)

ANTI-STATIC HOSE

The DWV902M-XE is equipped with an anti-static grounding system. An anti-static hose must be purchased at extra cost from your authorised service center. This hose (DWV9316) fits into the dust extractor system the same way as the standard hose. To contact your seller or check the location of your nearest authorised DeWALT repair agent in the DeWALT catalogue or contact your DeWALT office at the address indicated in this manual.

INTENDED USE

These vacuums are used for fine particulate pick-up, like wallboard, concrete or surface dust.

This appliance can be used as industrial vacuum cleaner and dust extractor for mobile operations to take up all types of dry, non-combustible dusts up to dust Class M with limit values for occupational exposure greater than or equal to 0.1 mg/m³.

DO NOT use in rain or in presence of flammable liquids or gases.

These heavy-duty vacuums are for professional use. **DO NOT** let children come into contact with the tool. Supervision is required when inexperienced operators use this appliance.

DO NOT use the dust extractor for combustible dust.

DO NOT use the dust extractor in explosive atmospheres.

NOTE: This appliance is suited for the commercial use, e.g. in hotels, schools, hospitals, factories, shops, offices, rental companies, and on construction sites.

ASSEMBLY AND ADJUSTMENTS (Fig. 1–3)

⚠ WARNING: To reduce the risk of serious personal injury, turn appliance off and disconnect appliance from power source before making any adjustments or removing/installing attachments or accessories. An accidental start-up can cause injury.

⚠ WARNING: When using electric appliances, always follow basic safety precautions to reduce the risk of fire, electric shock and personal injury.

⚠ WARNING: The filters (I) must always be in place while vacuuming, except as described under **Wet Pick Up Applications** under **Operation**. When vacuuming fine dust, you may also use an additional paper bag or fleece bag to make emptying the canister easier.

1. If optional paper or fleece bag (T) is to be used, install as shown in Figure 2.

NOTE: Be careful not to tear the bag. Place bag securely onto inlet (J) to provide a tight seal for maximum dust collection performance.

FIG. 2

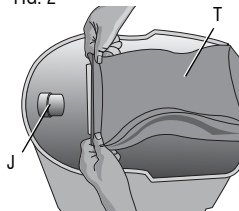
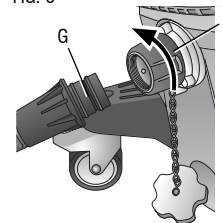

FIG. 3



2. Place the vacuum head (C) onto the canister and secure it by closing the canister latches (D).
3. Insert end of hose (G) into twist-lock hose inlet (J) and rotate counterclockwise to lock in place.

OPERATION

⚠ WARNING: To reduce the risk of serious personal injury, turn appliance off and disconnect appliance from power source before making any adjustments or removing/installing attachments or accessories. An accidental start-up can cause injury.

1. Plug the power cord into an appropriate outlet.
2. Turn the on/off/tool control switch (O) to the ON position (I).
3. Set the variable suction dial (N) to the desired position. This feature allows the user to control the vacuum's power, suction and noise.

FIG. 4

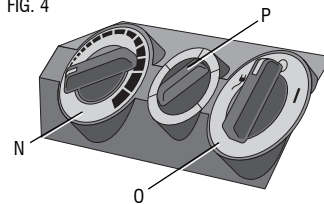

NOTE: This setting also controls the level of suction. This is very useful in applications where the vacuum creates unacceptable levels of drag to the work piece.

4. Follow the direction under **Connecting to Power Tools** to connect to the power tool to be used.

FLOW ALARM ADJUSTMENT (FIG. 4)

Adjust the flow alarm adjustment control (P) to the correct hose (or tube) inside diameter size or accessory diameter referring to the largest section. The chosen diameter of the adjustment control must be equal or bigger as the largest diameter of the used hose/tube/ accessories. The hose supplied is 32 mm inside diameter. An acoustic alarm will sound if the flow rate falls below 20 m/s. The system has a time delay to reduce unintended alarms.

CONNECTING TO POWER TOOLS (FIG. 1, 4, 5)

⚠ WARNING: Only use the outlet (M) for purposes specified in the instructions.

1. Plug the vacuum power cord into an appropriate outlet.
2. Plug the power tool into the outlet (M).

NOTE: See **Power connection data of power tool** under **Technical Data** for the power allowance of the tool to be plugged into the outlet (M).

3. Turn on/off/tool control switch (O) to the ACTIVATION position . This allows the vacuum to be turned on and off automatically by the power tool.

NOTE: The vacuum cleaner starts automatically within 0.5 seconds and continues to run for 15 seconds after the power tool has been turned off.

4. To switch back to manual mode, turn the on/off/tool control switch (O) to the ON position (I). In manual mode the tool and the vacuum are turned on and off independent of each other.

FIG. 5

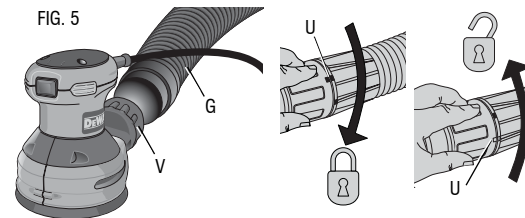

5. Your DEWALT construction dust extractor is fitted with the DEWALT AirLock connection system. The AirLock allows for a fast, secure connection between the suction hose (G) and power tool. The AirLock connector (V) connects directly to DEWALT compatible tools or through the use of an AirLock adapter (available from your local DEWALT supplier). Refer to the **Accessories** section for details on available adapters.

NOTE: If using an adapter, ensure it is firmly attached to the tool outlet before following the steps below.

- a. Ensure the collar on the AirLock connector is in the unlock position. Align notches (U) on collar and AirLock connector as shown for unlock and lock positions.
- b. Push the AirLock connector onto the adapter connector point.
- c. Rotate the collar to the locked position.

NOTE: The ball bearings inside collar lock into slot and secure the connection. The power tool is now securely connected to the dust extractor.

AUTOMATIC FILTER CLEANING SYSTEM

This vacuum has a highly effective filter cleaning system which minimizes filter clogging. Every 30 seconds, one of the two filters gets automatically cleaned. The cleaning process alternates between the filters and continues through the life of the unit.

NOTE: It is normal to hear a clicking sound during this process.

NOTE: After many hours of operation the automatic filter cleaning system may not be effective. When this happens the filters will need to be cleaned or replaced. Refer to **Filter** under **Maintenance**.

PARKING BRAKE (FIG. 1, 6)

The parking brake will lock one wheel in place to prevent vacuum from rolling.

1. To engage parking brake, depress the brake button (W) to snap the brake into the locked position.
2. To disengage parking brake, depress the brake button and brake will snap into the unlocked position.

FIG. 6

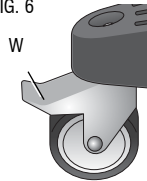

REMOVE / CHANGE USED DUST COLLECTION BAG (FIG. 1)

⚠WARNING: Appropriate personal protective equipment like dust mask and gloves should be used while handling used dust bags.

1. Turn off vacuum and unplug cord from outlet.
2. Close the twist-lock hose inlet (J) with the inlet plug (S).
3. Unlatch canister latches (D) and remove vacuum head (C)
4. Pull the collection bag carefully from inlet (J).
5. Seal the collection bag opening tightly when removing it from the machine.
6. Dispose of collection bag in appropriate container according to statutory provisions.

WET PICK UP APPLICATIONS (FIG. 1, 7)

⚠WARNING: DO NOT connect power tools to outlet (M) when using the vacuum for wet pick up.

⚠WARNING: Plug vacuum into GFCI protected outlet when using the vacuum for wet pick up.

⚠WARNING: If foam or liquid escapes from the machine, switch off immediately.

⚠CAUTION: Clean the water level limiting device regularly and examine it for signs of damage.

NOTICE: DO NOT remove ball float (X), doing so will cause damage to the vacuum. The ball float keeps water from entering the motor.

Before using the vacuum for wet pick up:

- Ensure the canister is empty and free of excessive dust.
- Remove filters (I).
- Plug vacuum into a GFCI protected outlet.

TO EMPTY CANISTER (FIG. 1, 7)

The ball float valve (X) will block air to the motor when the canister is full and the sound of the motor will change at once. When the motor has a high pitched sound and air/water flow stops, empty the canister.

1. Turn off vacuum and unplug cord from outlet.
2. Unlatch canister latches (D) and remove vacuum head (C).
3. Empty contents of canister (F) into a suitable container or drain.

TO CONVERT BACK TO DRY VACUUM OPERATION (FIG. 1)

1. Empty canister, refer to **To Empty Canister** instructions.
2. Place canister upside down position until dry. DO NOT use wet canister for dry pick up.
3. Place vacuum head (C) on a level surface until dry.
4. Reinstall filters when vacuum head is dry. See **Filters** under **Maintenance**.
5. When canister is dry place the vacuum head (C) onto the canister and secure it by closing the canister latches (D).

FIG. 7

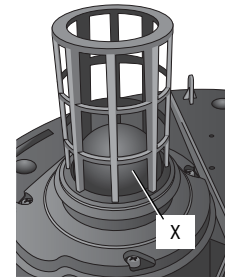

TELESCOPING HANDLE (FIG. 1, 8)

Press release button (Q) to raise and lower the telescoping handle (R).

To Shut Down/Transportation (Fig. 1, 11)

1. Turn on/off/tool control switch (O) to the OFF position.
2. Unplug the unit.
3. Close the twist-lock hose inlet (J) with the inlet plug (S).
4. Store the power cord (B) as shown.
5. When transporting in vehicles, secure the machine.

MAINTENANCE

⚠ WARNING: To reduce the risk of serious personal injury, turn appliance off and disconnect appliance from power source before making any adjustments or removing/installing attachments or accessories. An accidental start-up can cause injury.

⚠ WARNING: For user servicing, the machine must be dismantled, cleaned and serviced, as far as is reasonably practicable, without causing risk to the maintenance staff and others. Suitable precautions include, decontamination before dismantling, provision for local filtered exhaust ventilation where the machine is dismantled, cleaning of the maintenance area and suitable personal protection.

- The manufacturer, or an instructed person, shall perform a technical inspection at least annually, consisting of, for example, inspection of filters for damage, air tightness of the machine and proper function of the control mechanism.
- When carrying out service or repair operations, all contaminated items which cannot be satisfactorily cleaned, are to be disposed of; such items shall be disposed of in impervious bags in accordance with any current regulation for the disposal of such waste.
- For Class M machines the outside of the machine should be decontaminated by vacuum cleaning methods and wiped clean or treated with sealant before being taken out of a hazardous area. All the machine parts shall be regarded

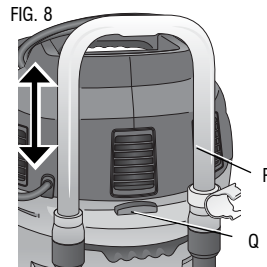

as contaminated when removed from the hazardous area and appropriate action taken to prevent dust dispersal.

- For dust extractors it is necessary to provide for an adequate air change rate L in the room if the exhaust air is returned to the room.

(NOTE: Reference to National Regulations is necessary.)

Filters (Fig. 1, 9, 10)

FILTER CARE

The filters included with this vacuum are long life filters. To be effective in minimizing dust recirculation, the filters MUST be installed correctly and in good condition.

⚠ WARNING: Never use compressed air or a brush to clean filters, otherwise damage to the filter membrane will occur which will allow dust to pass through the filter. If needed, gently tap against a hard surface or rinse with room temperature water and let air dry. Cleaning of the filters is typically unnecessary. Even if the filter is covered with dust, the automatic filter cleaning system will maintain maximum performance and continue to function. If visual damage to the filter membrane exists, replace filters. Filters typically last between six and twelve months, depending on use and care.

⚠ WARNING: Appropriate personal protective equipment like dust mask and gloves should be used while handling the filters.

To Remove Filters

1. Turn on/off/tool control switch (O) to the OFF position (O) and unplug cord from outlet.
 2. Release canister latches (D) and remove vacuum head (C) from canister. Place vacuum head on a level surface upside down.
 3. Turn each filter (I) counterclockwise by gripping it on the plastic end cover as shown, and carefully remove from head, ensuring debris does not fall into mounting hole.
- NOTE:** Use care to not damage filter material.
4. If the bottom side of the vacuum head (C) needs to be cleaned, use a cloth dampened with water and mild soap and allow it to dry. Dispose of cloth in an appropriate container.

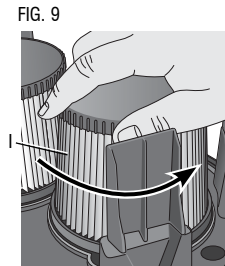

5. Inspect filters for wear, tears or other damage.

NOTE: If there is any doubt on the condition of the filters they **MUST** be replaced. **DO NOT** continue use if filters are damaged.

6. If **no damage to filters:** Wash filters in low pressure, room temperature water and allowed to dry. Filters may be reinstalled after they are completely dry, refer to **To Install Filters**.

To Install Filters

1. Ensure filter seal (Z) is in place and is secure

FIG. 10

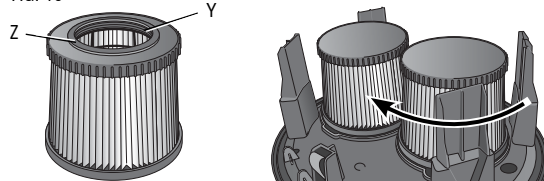

2. Line up filter threads (Y) to vacuum head threads and using moderate force, turn filter clockwise until tight.

NOTE: Use care to not damage filter material.

3. Place the vacuum head (C) onto the container and secure it by closing the canister latches (D).

Lubrication

Your power appliance requires no additional lubrication.

Cleaning

▲WARNING: Never use solvents or other harsh chemicals for cleaning the non-metallic parts of the appliance. These chemicals may weaken the materials used in these parts. Never let any liquid get inside the machine; never immerse any part of the appliance into a liquid.

1. Vacuum the outside of the dust extractor. For further cleaning use a cloth dampened only with water and mild soap if necessary.
2. After use dispose of cloth in an appropriate container.

Storage (Fig. 11)

1. Empty the canister, refer to **To Empty Canister** under **Operation**.
2. Clean the vacuum inside and outside. Refer to **Cleaning**.
3. Clean or replace filters, refer to **Filters**.
4. Store the suction hose and the power cord as shown in figure 11. Place the unit in a dry room and secure it from unauthorized use.

NOTE: Plug inlet plug (S) into inlet (J) to keep debris inside canister when suction hose is removed. You can also attach the ends of the hose together and lock together with the twist-lock end.

FIG. 11

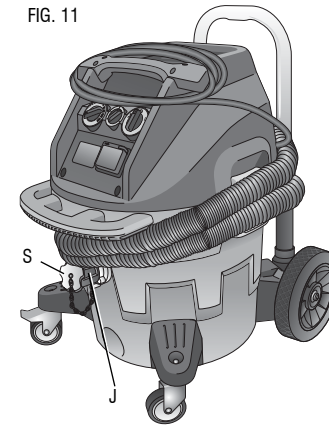

Repairs







To assure product SAFETY and RELIABILITY, repairs, maintenance and adjustment (including brush inspection and replacement) should be performed by certified service centers or other qualified service organizations, always using identical replacement parts.



Accessories

▲WARNING: Since accessories, other than those offered by DEWALT, have not been tested with this product, use of such accessories with this appliance could be hazardous. To reduce the risk of injury, only DEWALT recommended accessories should be used with this product.

Recommended accessories for use with your appliance are available at extra cost from your local service center. If you need any assistance in locating any accessory, please contact Stanley Black & Decker, 82 Taryn Drive, Epping, VIC 3076 Australia or call 1800 444 224 or (NZ) 0800 339 258.

OPTIONAL ACCESSORIES

	DWV9310-XJ	HE Filter: Captures 99.0% of all particles greater or equal to 0.3 microns.
	DWE46100	127–152 mm (5"–6") Cutting/tuckpointing shroud
	DWE46150	127 mm (5") Cutting/tuckpointing shroud
	DWH050K	DWH050 drilling dust extraction system
	DWH052K	DWH052 demolition dust extraction system
	DWH053K	DWH053 chipping dust extraction system

	DWV9316-XJ	Anti-static 4.6 m (15') hose
	DWV9315-XJ	Crush proof 4.6 m (15') hose

The filter bags provide a clean, easy and quick way to dispose of the dust collected.

Paper filter bags: The DWV9401 filter bags are designed to capture many types of dust including drywall, concrete and wood. They provide filtration performance of 99.9% at 2 microns. These bags should be disposed of once the airflow becomes restricted. DO NOT reuse bags.

	DWV9401-XJ	Disposable paper filter bag 19 L (5 gallon)
---	------------	--

Fleece filter bag: The DWV9402 fleece bag is designed to capture many types of dust including drywall, concrete and wood. It provides filtration performance of 95% at 0.3 microns. This bag should be disposed of once the airflow becomes restricted. DO NOT reuse this bag. The fleece bag is ideal for heavier materials such as concrete and drywall dust where a paper filter bag may tear.

	DWV9402-XJ	Disposable fleece filter bag 12 L (3.3 gallon)
--	------------	---

The DWV9400 disposable plastic bag is designed to seal the liner to the tank inlet without being pulled into the filter during use. The plastic disposable bag allows for easy cleanup and disposal of dust and keeps dust from escaping back into the atmosphere during emptying. Because this bag is specially designed not to be pulled into the filter, there will be a small amount of dust remaining in the tank.

	DWV9400-XJ	Disposable plastic collection bag 21.6 L (5.7 gallon)
---	------------	--

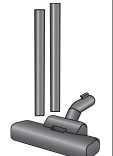
	D279059B	Dust extraction beater bar kit
---	----------	--------------------------------

TROUBLESHOOTING

PROBLEM	SOLUTION
Motor does not run	Check power cord, plugs and outlet. Ensure the on/off /tool control switch is in the ON position (I).
Suction capacity decreases	Remove blockages in the suction nozzle, suction tube, suction hose or filters. Replace the paper or fleece bag. Check for proper installation of the filters. Clean or replace the filters. Empty canister, refer to Empty Canister under Operation .
Vacuum stops running	Thermal overload has been tripped: <ol style="list-style-type: none"> 1. Turn the vacuum off and disconnect vacuum cleaner from power source. 2. Empty the canister, if needed. 3. Allow the unit to cool. 4. Plug the power cord into an appropriate outlet and turn on/off/tool control switch to the ON position (I) to test. If vacuum will not restart call 1800 444 224 or (NZ) 0800 339 258.

PROBLEM	SOLUTION
Dust comes out while vacuuming	Check for proper installation of the filters. Ensure filters are not damaged; replace if necessary. Ensure filter seals are in place and are secure.
Automatic filter cleaning is not working	Listen for the solenoid clicking to ensure the filter cleaning mechanism is working.
Power tool does not turn on.	Ensure the on/off/tool control switch is in the ACTIVATION position  .







Stanley Black & Decker
82 Taryn Drive, Epping, VIC 3076 Australia • 1800 444 224 (Aust) or 0800 339 258 (NZ)
www.dewalt.com.au • www.dewalt.co.nz

(DEC12) Part No. N246440 DWV902M-XE Copyright © 2012 DeWALT

The following are trademarks for one or more DeWALT power tools: the yellow and black color scheme; the "D" shaped air intake grill; the array of pyramids on the handgrip; the kit box configuration; and the array of lozenge-shaped humps on the surface of the tool.