

**DEWALT**®

***XR LI-ION***

**[www.DEWALT.com](http://www.DEWALT.com)**

**DCH143  
DCH243  
DCH253  
DCH254**



Figure 1

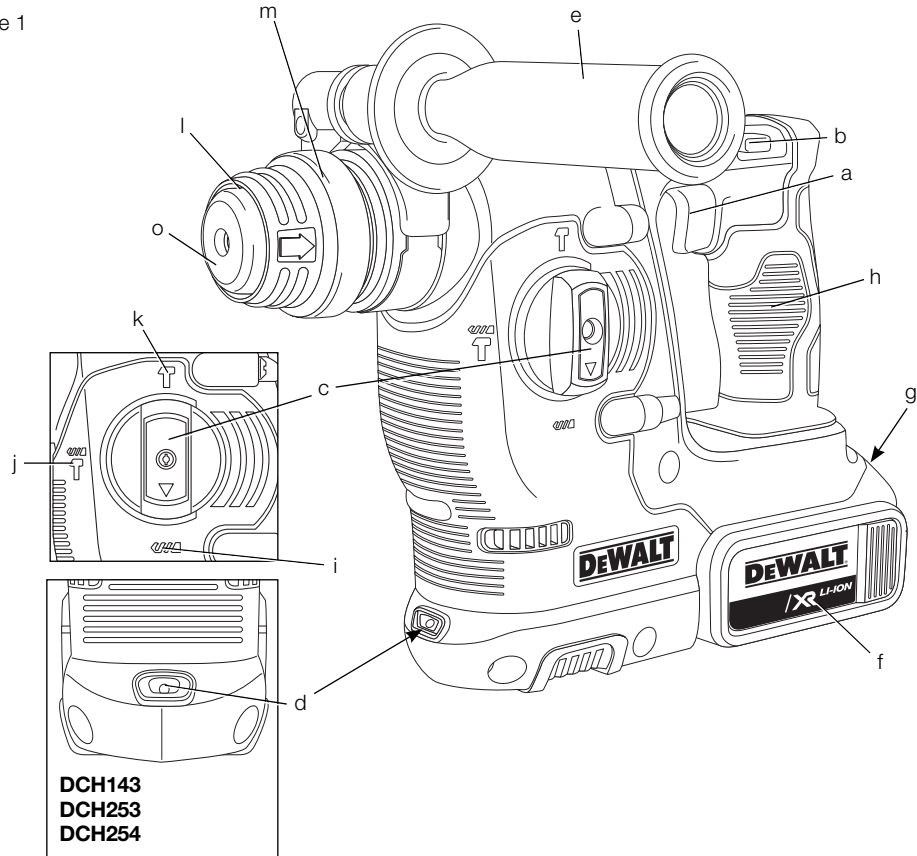

Figure 2

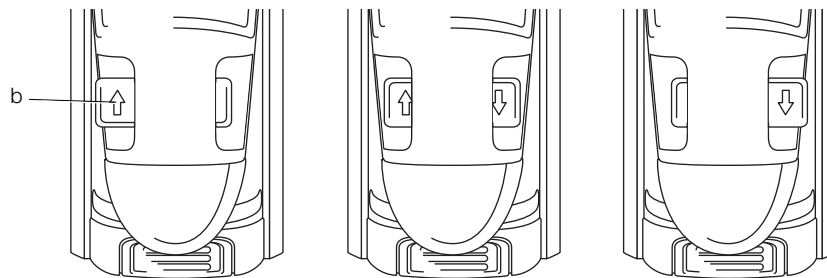

Figure 3

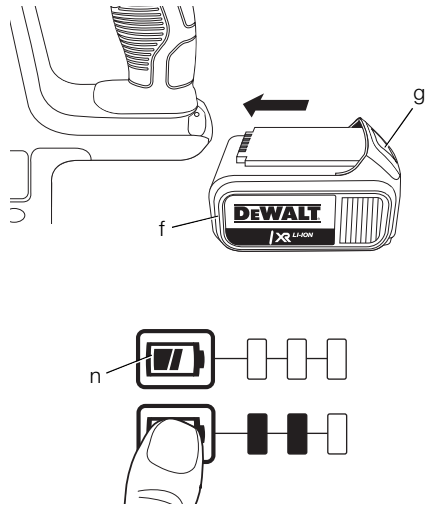

Figure 4

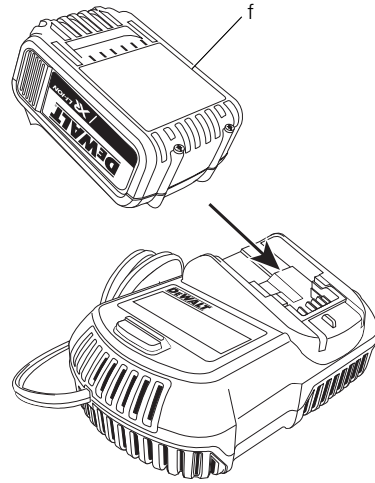

Figure 5

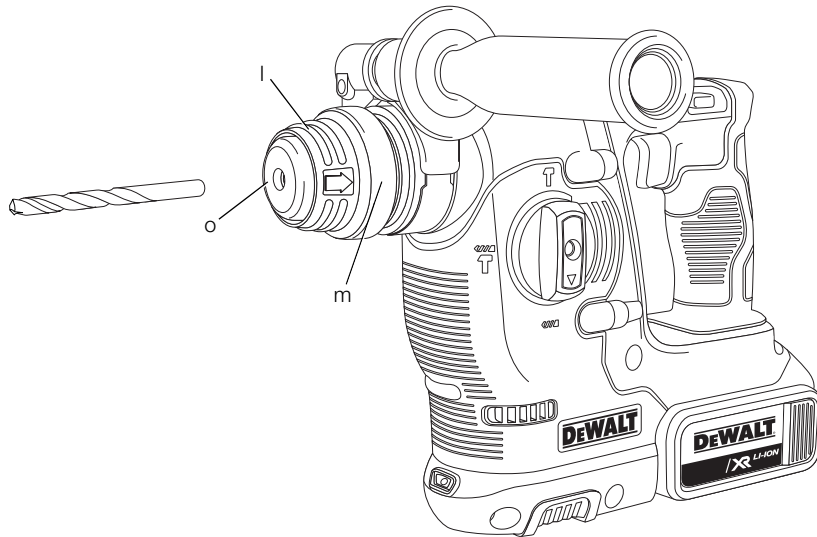

Figure 6

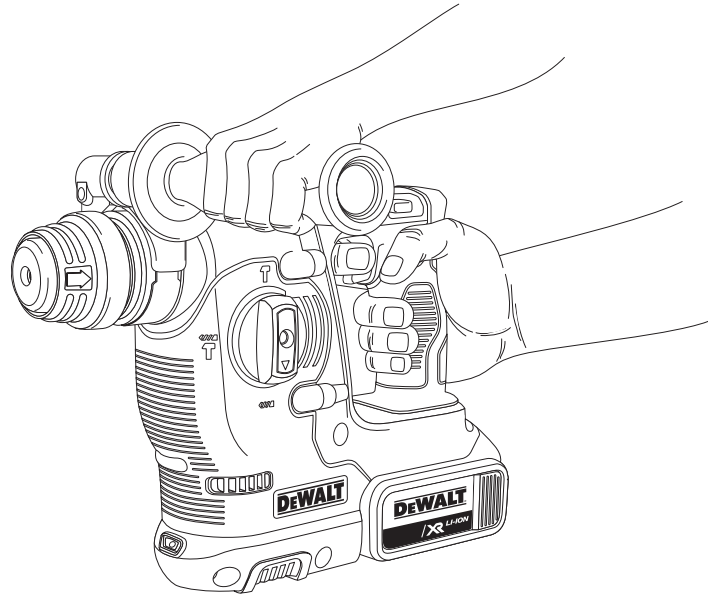
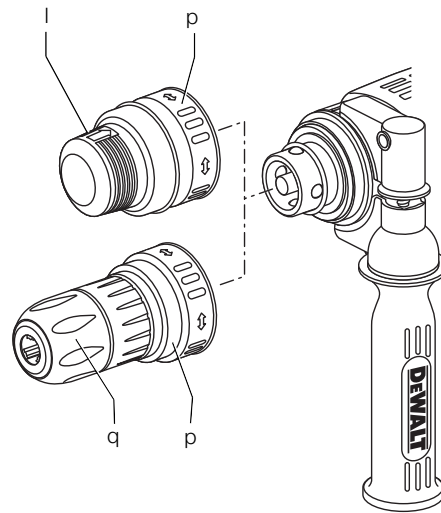

Figure 7

**DCH254**



ENGLISH

## HEAVY-DUTY CORDLESS ROTARY HAMMERDRILL DCH143, DCH243, DCH253, DCH254

### Congratulations!

You have chosen a DEWALT tool. Years of experience, thorough product development and innovation make DEWALT one of the most reliable partners for professional power tool users.

### Technical Data

		DCH143	DCH243	DCH253	DCH254
Voltage	$V_{DC}$	14.4	18	18	18
Type		1	1	1	1
No-load speed	$\text{min}^{-1}$	1100	1150	1200	1200
Impact rate	$\text{min}^{-1}$	4350	4400	4500	4500
Impact energy (EPTA 05/2009)	J	2	2.1	2.1	2.1
Maximum drilling range					
in steel/wood/concrete	mm	10/20/20	13/26/20	13/26/24	13/26/24
Chuck		SDS Plus®	SDS Plus®	SDS Plus®	SDS Plus®
Collar diameter	mm	54	54	54	54
Battery Type		Li-Ion	Li-Ion	Li-Ion	Li-Ion
Weight (without battery pack)	kg	2.5	2.4	2.5	2.6
$L_{PA}$ (sound pressure)	dB(A)	86	86	86	86
$K_{PA}$ (sound pressure uncertainty)	dB(A)	3	3	3	3
$L_{WA}$ (sound power)	dB(A)	97	97	97	97
$K_{WA}$ (sound power uncertainty)	dB(A)	3	3	3	3

Vibration total values (triax vector sum) determined according to EN 60745:

Vibration emission value  $a_h$

Drilling into concrete

$a_{h,HD} =$	$\text{m/s}^2$	6.6	7.4	6.6	6.6
Uncertainty K =	$\text{m/s}^2$	1.5	1.5	1.5	1.5

Vibration emission value  $a_h$

Chiselling

$a_{h,Cheq} =$	$\text{m/s}^2$	5.4	6.0	5.4	5.4
Uncertainty K =	$\text{m/s}^2$	1.5	1.5	1.5	1.5

Vibration emission value  $a_h$

Drilling into metal

$a_{h,D} =$	$\text{m/s}^2$	$\leq 2.5$	$\leq 2.5$	$\leq 2.5$	$\leq 2.5$
Uncertainty K =	$\text{m/s}^2$	1.5	1.5	1.5	1.5

Vibration emission value  $a_h$

Screwdriving

$a_h =$	$\text{m/s}^2$	$\leq 2.5$	$\leq 2.5$	$\leq 2.5$	$\leq 2.5$
Uncertainty K =	$\text{m/s}^2$	1.5	1.5	1.5	1.5

The vibration emission level given in this information sheet has been measured in accordance with a standardised test given in EN 60745 and may be used to compare one tool with another. It may be used for a preliminary assessment of exposure.



**WARNING:** The declared vibration emission level represents the main applications of the tool. However if the tool is used for different applications, with different accessories or poorly maintained, the vibration emission may differ. This may significantly increase the exposure level over the total working period.

An estimation of the level of exposure to vibration should also take into account the times when the tool is switched off or when it is running but not actually doing the job. This may significantly reduce the exposure level over the total working period.

Identify additional safety measures to protect the operator from the effects of vibration such as: maintain the tool and the accessories, keep the hands warm, organisation of work patterns.

Battery pack		DCB140	DCB141	DCB142	DCB180	DCB181	DCB182	DCB183
Battery type		Li-Ion	Li-Ion	Li-Ion	Li-Ion	Li-Ion	Li-Ion	Li-Ion
Voltage	$V_{DC}$	14.4	14.4	14.4	18	18	18	18
Capacity	$A_h$	3.0	1.5	4.0	3.0	1.5	4.0	2.0
Weight	kg	0.53	0.30	0.54	0.64	0.35	0.61	0.40

Charger		DCB105			
Mains voltage	$V_{AC}$	230 V			
Battery type		Li-Ion			
Approx. charging time	min	30 (1.5 Ah battery packs)	45 (2.0 Ah battery packs)	55 (3.0 Ah battery packs)	70 (4.0 Ah battery packs)
Weight	kg	0.49			

Fuses:		
Europe	230 V tools	10 Amperes, mains
U.K. & Ireland	230 V tools	3 Amperes, in plugs



Denotes risk of electric shock.



Denotes risk of fire.

## Definitions: Safety Guidelines

The definitions below describe the level of severity for each signal word. Please read the manual and pay attention to these symbols.



**DANGER:** Indicates an imminently hazardous situation which, if not avoided, **will** result in **death or serious injury**.



**WARNING:** Indicates a potentially hazardous situation which, if not avoided, **could** result in **death or serious injury**.



**CAUTION:** Indicates a potentially hazardous situation which, if not avoided, **may** result in **minor or moderate injury**.

**NOTICE:** Indicates a practice **not related to personal injury** which, if not avoided, **may** result in **property damage**.

## EC-Declaration of Conformity

### MACHINERY DIRECTIVE



### DCH143, DCH243, DCH253, DCH254

DEWALT declares that these products described under **Technical Data** are in compliance with: 2006/42/EC, EN 60745-1, EN 60745-2-6.

These products also comply with Directive 2004/108/EC and 2011/65/EU. For more information, please contact DEWALT at the following address or refer to the back of the manual.

The undersigned is responsible for compilation of the technical file and makes this declaration on behalf of DEWALT.



Horst Grossmann  
 Vice President Engineering and Product  
 Development  
 DEWALT, Richard-Klinger-Straße 11,  
 D-65510, Idstein, Germany  
 01.01.2013



**WARNING:** To reduce the risk of injury,  
 read the instruction manual.

## General Power Tool Safety Warnings



**WARNING! Read all safety warnings  
 and all instructions.** Failure to follow  
 the warnings and instructions may result  
 in electric shock, fire and/or serious  
 injury.

### SAVE ALL WARNINGS AND INSTRUCTIONS FOR FUTURE REFERENCE

The term "power tool" in the warnings refers to your  
 mains-operated (corded) power tool or battery-  
 operated (cordless) power tool.

#### 1) WORK AREA SAFETY

- a) **Keep work area clean and well lit.**  
 Cluttered or dark areas invite accidents.
- b) **Do not operate power tools in explosive  
 atmospheres, such as in the presence of  
 flammable liquids, gases or dust.** Power  
 tools create sparks which may ignite the dust  
 or fumes.
- c) **Keep children and bystanders away while  
 operating a power tool.** Distractions can  
 cause you to lose control.

#### 2) ELECTRICAL SAFETY

- a) **Power tool plugs must match the outlet.**  
**Never modify the plug in any way. Do  
 not use any adapter plugs with earthed  
 (grounded) power tools.** Unmodified plugs  
 and matching outlets will reduce risk of  
 electric shock.
- b) **Avoid body contact with earthed or  
 grounded surfaces such as pipes,  
 radiators, ranges and refrigerators.** There  
 is an increased risk of electric shock if your  
 body is earthed or grounded.
- c) **Do not expose power tools to rain or wet  
 conditions.** Water entering a power tool will  
 increase the risk of electric shock.

- d) **Do not abuse the cord. Never use the  
 cord for carrying, pulling or unplugging  
 the power tool. Keep cord away from  
 heat, oil, sharp edges or moving parts.**  
 Damaged or entangled cords increase the  
 risk of electric shock.
- e) **When operating a power tool outdoors,  
 use an extension cord suitable for outdoor  
 use.** Use of a cord suitable for outdoor use  
 reduces the risk of electric shock.
- f) **If operating a power tool in a damp  
 location is unavoidable, use a residual  
 current device (RCD) protected supply.**  
 Use of an RCD reduces the risk of electric  
 shock.

#### 3) PERSONAL SAFETY

- a) **Stay alert, watch what you are doing and  
 use common sense when operating a  
 power tool. Do not use a power tool while  
 you are tired or under the influence of  
 drugs, alcohol or medication.** A moment of  
 inattention while operating power tools may  
 result in serious personal injury.
- b) **Use personal protective equipment.**  
**Always wear eye protection.** Protective  
 equipment such as dust mask, non-skid  
 safety shoes, hard hat, or hearing protection  
 used for appropriate conditions will reduce  
 personal injuries.
- c) **Prevent unintentional starting. Ensure  
 the switch is in the off position before  
 connecting to power source and/or  
 battery pack, picking up or carrying the  
 tool.** Carrying power tools with your finger  
 on the switch or energising power tools that  
 have the switch on invites accidents.
- d) **Remove any adjusting key or wrench  
 before turning the power tool on.** A  
 wrench or a key left attached to a rotating  
 part of the power tool may result in personal  
 injury.
- e) **Do not overreach. Keep proper  
 footing and balance at all times.** This  
 enables better control of the power tool in  
 unexpected situations.
- f) **Dress properly. Do not wear loose  
 clothing or jewellery. Keep your hair,  
 clothing and gloves away from moving  
 parts.** Loose clothes, jewellery or long hair  
 can be caught in moving parts.
- g) **If devices are provided for the connection  
 of dust extraction and collection facilities,  
 ensure these are connected and properly  
 used.** Use of dust collection can reduce  
 dust-related hazards.



**4) POWER TOOL USE AND CARE**

- a) **Do not force the power tool. Use the correct power tool for your application.** The correct power tool will do the job better and safer at the rate for which it was designed.
- b) **Do not use the power tool if the switch does not turn it on and off.** Any power tool that cannot be controlled with the switch is dangerous and must be repaired.
- c) **Disconnect the plug from the power source and/or the battery pack from the power tool before making any adjustments, changing accessories, or storing power tools.** Such preventive safety measures reduce the risk of starting the power tool accidentally.
- d) **Store idle power tools out of the reach of children and do not allow persons unfamiliar with the power tool or these instructions to operate the power tool.** Power tools are dangerous in the hands of untrained users.
- e) **Maintain power tools. Check for misalignment or binding of moving parts, breakage of parts and any other condition that may affect the power tool's operation. If damaged, have the power tool repaired before use.** Many accidents are caused by poorly maintained power tools.
- f) **Keep cutting tools sharp and clean.** Properly maintained cutting tools with sharp cutting edges are less likely to bind and are easier to control.
- g) **Use the power tool, accessories and tool bits etc., in accordance with these instructions taking into account the working conditions and the work to be performed.** Use of the power tool for operations different from those intended could result in a hazardous situation.

**5) BATTERY TOOL USE AND CARE**

- a) **Recharge only with the charger specified by the manufacturer.** A charger that is suitable for one type of battery pack may create a risk of fire when used with another battery pack.
- b) **Use power tools only with specifically designated battery packs.** Use of any other battery packs may create a risk of injury and fire.
- c) **When battery pack is not in use, keep it away from other metal objects like paper clips, coins, keys, nails, screws or other small metal objects that can make a connection from one terminal to another.** Shorting the battery terminals together may cause burns or a fire.

- d) **Under abusive conditions, liquid may be ejected from the battery, avoid contact. If contact accidentally occurs, flush with water. If liquid contacts eyes, additionally seek medical help.** Liquid ejected from the battery may cause irritation or burns.

**6) SERVICE**

- a) **Have your power tool serviced by a qualified repair person using only identical replacement parts.** This will ensure that the safety of the power tool is maintained.

**Additional Safety Instructions for Rotary Hammers**

- **Wear ear protectors.** Exposure to noise can cause hearing loss.
- **Use auxiliary handles supplied with the tool.** Loss of control can cause personal injury.
- **Hold power tools by insulated gripping surfaces when performing an operation where the cutting tool may contact hidden wiring.** Contact with a "live" wire will make exposed metal parts of the tool "live" and could give the operator an electrical shock.
- **Use clamps or other practical way to secure and support the workpiece to a stable platform.** Holding the work by hand or against your body is unstable and may lead to loss of control.
- **Wear safety goggles or other eye protection.** Hammering operations cause chips to fly. Flying particles can cause permanent eye damage. Wear a dust mask or respirator for applications that generate dust. Ear protection may be required for most applications.
- **Keep a firm grip on the tool at all times. Do not attempt to operate this tool without holding it with both hands.** It is recommended that the side handle be used at all times. Operating this tool with one hand will result in loss of control. Breaking through or encountering hard materials such as re-bar may be hazardous as well. Tighten the side handle securely before use.
- **Do not operate this tool for long periods of time.** Vibration caused by hammer action may be harmful to your hands and arms. Use gloves to provide extra cushion and limit exposure by taking frequent rest periods.
- **Do not recondition bits yourself.** Chisel reconditioning should be done by an authorized specialist. Improperly reconditioned chisels could cause injury.

## ENGLISH

- **Wear gloves when operating tool or changing bits.** Accessible metal parts on the tool and bits may get extremely hot during operation. Small bits of broken material may damage bare hands.
- **Never lay the tool down until the bit has come to a complete stop.** Moving bits could cause injury.
- **Do not strike jammed bits with a hammer to dislodge them.** Fragments of metal or material chips could dislodge and cause injury.
- **Slightly worn chisels can be resharpened by grinding.**
- **Keep the power cord away from the rotating bit.** Do not wrap the cord around any part of your body. An electric cord wrapped around a spinning bit may cause personal injury and loss of control.

## Residual Risks

The following risks are inherent to the use of rotary hammers:

- Injuries caused by touching the rotating parts or hot parts of the tool.

In spite of the application of the relevant safety regulations and the implementation of safety devices, certain residual risks cannot be avoided. These are:

- Impairment of hearing.
- Risk of squeezing fingers when changing the accessory.
- Health hazards caused by breathing dust developed when working in concrete and/or masonry.

## Markings on Tool

The following pictograms are shown on the tool:



Read instruction manual before use.



Wear ear protection.



Wear eye protection.

## DATE CODE POSITION

The date code, which also includes the year of manufacture, is printed into the housing surface that forms the mounting joint between tool and battery.

Example:

2013 XX XX

Year of Manufacture

## Important Safety Instructions for All Battery Chargers

**SAVE THESE INSTRUCTIONS:** This manual contains important safety and operating instructions for the DCB105 battery charger.

- Before using the charger, read all instructions and cautionary markings on charger, battery pack and product using the battery pack.



**WARNING:** Shock hazard. Do not allow any liquid to get inside charger. Electric shock may result.



**CAUTION:** Burn hazard. To reduce the risk of injury, charge only DEWALT rechargeable battery packs. Other types of batteries may overheat and burst resulting in personal injury and property damage.



**CAUTION:** Children should be supervised to ensure that they do not play with the appliance.

**NOTICE:** Under certain conditions, with the charger plugged in to the power supply, the exposed charging contacts inside the charger can be shorted by foreign material. Foreign materials of a conductive nature such as, but not limited to, steel wool, aluminum foil or any buildup of metallic particles should be kept away from charger cavities. Always unplug the charger from the power supply when there is no battery pack in the cavity. Unplug charger before attempting to clean.

- **DO NOT attempt to charge the battery pack with any chargers other than the ones in this manual.** The charger and battery pack are specifically designed to work together.
- **These chargers are not intended for any uses other than charging DEWALT rechargeable batteries.** Any other uses may result in risk of fire, electric shock or electrocution.
- **Do not expose charger to rain or snow.**
- **Pull by plug rather than cord when disconnecting charger.** This will reduce risk of damage to electric plug and cord.

- **Make sure that cord is located so that it will not be stepped on, tripped over or otherwise subjected to damage or stress.**
- **Do not use an extension cord unless it is absolutely necessary.** Use of improper extension cord could result in risk of fire, electric shock or electrocution.
- **When operating a charger outdoors, always provide a dry location and use an extension cord suitable for outdoor use.** Use of a cord suitable for outdoor use reduces the risk of electric shock.
- **Do not block the ventilation slots on the charger. The ventilation slots are located on the top and sides of the charger.** Place the charger in a position away from any heat source.
- **Do not operate charger with damaged cord or plug — have them replaced immediately.**
- **Do not operate charger if it has received a sharp blow, been dropped or otherwise damaged in any way.** Take it to an authorised service centre.
- **Do not disassemble the charger; take it to an authorised service centre when service or repair is required.** Incorrect reassembly may result in a risk of electric shock, electrocution or fire.
- **In case of damaged power supply cord the supply cord must be replaced immediately by the manufacturer, its service agent or similar qualified person to prevent any hazard.**
- **Disconnect the charger from the outlet before attempting any cleaning. This will reduce the risk of electric shock.** Removing the battery pack will not reduce this risk.
- **NEVER attempt to connect 2 chargers together.**
- **The charger is designed to operate on standard 230 V household electrical power. Do not attempt to use it on any other voltage.** This does not apply to the vehicular charger.

**SAVE THESE INSTRUCTIONS**

**Chargers**

The DCB105 charger accepts 10.8 V, 14.4 V and 18 V Li-Ion (DCB121, DCB123, DCB140, DCB141, DCB142, DCB180, DCB181, DCB182 and DCB183) battery packs.

This charger requires no adjustment and is designed to be as easy as possible to operate.





**Charging Procedure (fig. 4)**

1. Plug the charger into an appropriate 230 V outlet before inserting the battery pack.
2. Insert the battery pack (f) into the charger, making sure the pack is fully seated in the charger. The red (charging) light will blink continuously indicating that the charging process has started.
3. The completion of charge will be indicated by the red light remaining ON continuously. The pack is fully charged and may be used at this time or left in the charger.

**NOTE:** To ensure maximum performance and life of Li-Ion batteries, charge the battery pack fully before first use.

**Charging Process**

Refer to the table below for the state of charge of the battery pack.

State of charge	
 charging	— — — —
 fully charged	—————
 hot/cold pack delay	— • — • — • — •
 problem pack or charger	••••••••••
 problem powerline	••••••••

This charger will not charge a faulty battery pack. The charger will indicate faulty battery by refusing to light or by displaying problem pack or charger blink pattern.

**NOTE:** This could also mean a problem with a charger.

If the charger indicates a problem, take the charger and battery pack to be tested at an authorised service centre.

**Hot/Cold Pack Delay**

When the charger detects a battery that is too hot or too cold, it automatically starts a hot/cold pack delay, suspending charging until the battery has reached an appropriate temperature. The charger then automatically switches to the pack charging mode. This feature ensures maximum battery life.

XR Li-Ion tools are designed with an Electronic Protection System that will protect the battery against overloading, overheating or deep discharge.

The tool will automatically turn off if the Electronic Protection System engages. If this occurs, place the Li-Ion battery on the charger until it is fully charged.

## ENGLISH

A cold battery pack will charge at about half the rate of a warm battery pack. The battery pack will charge at that slower rate throughout the entire charging cycle and will not return to maximum charge rate even if the battery warms.

### Important Safety Instructions for All Battery Packs

When ordering replacement battery packs, be sure to include the catalogue number and voltage.

The battery pack is not fully charged out of the carton. Before using the battery pack and charger, read the safety instructions below and then follow the charging procedures outlined.

#### READ ALL INSTRUCTIONS

- **Do not charge or use the battery pack in explosive atmospheres, such as in the presence of flammable liquids, gases or dust.** Inserting or removing the battery pack from the charger may ignite the dust or fumes.
- **Never force the battery pack into charger. Do not modify the battery pack in any way to fit into a non-compatible charger as battery pack may rupture causing serious personal injury.**
- Charge the battery packs only in designated DEWALT chargers.
- **DO NOT splash or immerse in water or other liquids.**
- **Do not store or use the tool and battery pack in locations where the temperature may reach or exceed 40 °C (105 °F) (such as outside sheds or metal buildings in summer).**
- For best results, make sure the battery pack is fully charged before use.



**WARNING:** Never attempt to open the battery pack for any reason. If the battery pack case is cracked or damaged, do not insert it into the charger. Do not crush, drop or damage battery pack. Do not use a battery pack or charger that has received a sharp blow, been dropped, run over or damaged in any way (e.g., pierced with a nail, hit with a hammer, stepped on). Electric shock or electrocution may result. Damaged battery packs should be returned to the service centre for recycling.



**CAUTION:** When not in use, place tool on its side on a stable surface where it will not cause a tripping or falling hazard. Some tools with large battery packs will stand upright on the battery pack but may be easily knocked over.

#### SPECIFIC SAFETY INSTRUCTIONS FOR LITHIUM ION (Li-Ion)

- **Do not incinerate the battery pack even if it is severely damaged or is completely worn out.** The battery pack can explode in a fire. Toxic fumes and materials are created when lithium ion battery packs are burned.
- **If battery contents come into contact with the skin, immediately wash the area with mild soap and water.** If the battery liquid gets into the eye, rinse water over the open eye for 15 minutes or until irritation ceases. If medical attention is needed, the battery electrolyte is composed of a mixture of liquid organic carbonates and lithium salts.
- **Contents of opened battery cells may cause respiratory irritation.** Provide fresh air. If symptoms persists, seek medical attention.



**WARNING:** Burn hazard. Battery liquid may be flammable if exposed to spark or flame.

### Battery Pack

#### BATTERY TYPE

The DCH143 operates on 14.4 V battery packs. The DCH243, DCH253 and DCH254 operate on 18 V battery packs.

The DCB140, DCB141 or DCB142 battery packs (14.4 V) may be used on the DCH143.

The DCB180, DCB181, DCB182 or DCB183 battery packs (18 V) may be used on the DCH243, DCH253 and DCH254.



















#### Storage Recommendations

1. The best storage place is one that is cool and dry away from direct sunlight and excess heat or cold. For optimum battery performance and life, store battery packs at room temperature when not in use.
2. For long storage, it is recommended to store a fully charged battery pack in a cool, dry place out of the charger for optimal results.

**NOTE:** Battery packs should not be stored completely depleted of charge. The battery pack will need to be recharged before use.

## Labels on Charger and Battery Pack

In addition to the pictographs used in this manual, the labels on the charger and the battery pack show the following pictographs:

-  Read instruction manual before use.
-  Read instruction manual before use.
-  Charging.
-  Fully charged.
-  Hot/cold pack delay.
-  Problem pack or charger.
-  Problem powerline.
-  Do not probe with conductive objects.
-  Do not charge damaged battery packs.
-  Use only with DEWALT battery packs. Others may burst, causing personal injury and damage.
-  Do not expose to water.
-  Have defective cords replaced immediately.
-  Charge only between 4 °C and 40 °C.
-  Discard the battery pack with due care for the environment.
-  Discard the battery pack with due care for the environment.
-  Do not incinerate the battery pack.
-  Li-Ion Charges Li-Ion battery packs.
-  See **Technical Data** for charging time.
-  Only for indoor use.

## Package Contents

The package contains:

- 1 Cordless rotary hammerdrill
- 1 Side handle
- 1 Charger
- 1 Battery pack (D1, L1, M1)
- 2 Battery packs (D2, L2, M2)
- 3 Battery packs (D3, L3, M3)
- 1 Keyless chuck (DCH253)
- 1 Kitbox
- 1 Instruction manual
- 1 Exploded drawing

**NOTE:** Battery packs and chargers are not included with N-models.

- Check for damage to the tool, parts or accessories which may have occurred during transport.
- Take the time to thoroughly read and understand this manual prior to operation.

## Description (fig. 1, 3, 7)



**WARNING:** Never modify the power tool or any part of it. Damage or personal injury could result.

- a. Variable speed switch
- b. Forward/reverse button
- c. Mode selector
- d. Worklight (DCH143, DCH253, DCH254)
- e. Side handle
- f. Battery pack
- g. Release button
- h. Main handle
  - i. Drill bit symbol (rotary drilling mode)
  - j. Hammerdrilling symbol (rotary hammering mode)
  - k. Hammer symbol (hammering only mode)
- l. SDS Plus® tool holder
- m. Sleeve
- n. fuel gauge button
- o. dust cover
- p. Locking collar
- q. Keyless chuck

## ENGLISH

### INTENDED USE

Your DCH143, DCH243, DCH253 and DCH254 cordless rotary hammerdrills have been designed for professional drilling and hammerdrilling applications, as well as screwdriving and chipping applications.

**DO NOT** use under wet conditions or in presence of flammable liquids or gases.

These hammerdrills are professional power tools.

**DO NOT** let children come into contact with the tool. Supervision is required when inexperienced operators use this tool.

- This product is not intended for use by persons (including children) suffering from diminished physical, sensory or mental abilities; lack of experience, knowledge or skills unless they are supervised by a person responsible for their safety. Children should never be left alone with this product.

### Electrical Safety

The electric motor has been designed for one voltage only. Always check that the battery pack voltage corresponds to the voltage on the rating plate. Also make sure that the voltage of your charger corresponds to that of your mains.



Your DEWALT charger is double insulated in accordance with EN 60335; therefore no earth wire is required.

If the supply cord is damaged, it must be replaced by a specially prepared cord available through the DEWALT service organization.

### Mains Plug Replacement (U.K. & Ireland Only)

If a new mains plug needs to be fitted:

- Safely dispose of the old plug.
- Connect the brown lead to the live terminal in the plug.
- Connect the blue lead to the neutral terminal.



**WARNING:** No connection is to be made to the earth terminal.

Follow the fitting instructions supplied with good quality plugs. Recommended fuse: 3 A.

### Using an Extension Cable

An extension cord should not be used unless absolutely necessary. Use an approved extension cable suitable for the power input of your charger (see **Technical Data**). The minimum conductor size is 1 mm<sup>2</sup>; the maximum length is 30 m.

When using a cable reel, always unwind the cable completely.

### ASSEMBLY AND ADJUSTMENTS



**WARNING:** Prior to assembly and adjustment, always remove the battery pack. Always switch off the tool before inserting or removing the battery pack.



**WARNING:** Use only DEWALT battery packs and chargers.

### Inserting and Removing the Battery Pack from the Tool (fig. 3)



**WARNING:** To reduce the risk of injury, never depress the battery release button without removing the battery pack. Depressing the battery release button without removing the battery pack can result in the battery pack falling out unexpectedly.

**NOTE:** For best results, make sure your battery pack is fully charged.

#### TO INSTALL THE BATTERY PACK INTO THE TOOL HANDLE

1. Align the battery pack (f) with the rails inside the tool's handle (fig. 3).
2. Slide it into the handle until the battery pack is firmly seated in the tool and ensure that it does not disengage.

#### TO REMOVE THE BATTERY PACK FROM THE TOOL

1. Press the battery release button (g) and firmly pull the battery pack out of the tool handle.
2. Insert battery pack into the charger as described in the charger section of this manual.

#### FUEL GAUGE BATTERY PACKS (FIG. 3)

Some DEWALT battery packs include a fuel gauge which consists of three green LED lights that indicate the level of charge remaining in the battery pack.

To actuate the fuel gauge, press and hold the fuel gauge button (n). A combination of the three green LED lights will illuminate designating the level of charge left. When the level of charge in the battery is below the usable limit, the fuel gauge will not illuminate and the battery will need to be recharged.

**NOTE:** The fuel gauge is only an indication of the charge left on the battery pack. It does not indicate tool functionality and is subject to variation based on product components, temperature and end-user application.

## Variable Speed Switch (fig. 1)

To turn the tool on, squeeze the trigger switch (a). To turn the tool off, release the trigger switch. Your tool is equipped with a brake. The tool holder will stop as soon as the trigger switch is fully released.

The variable speed trigger switch enables you to select the best speed for a particular application. The farther you squeeze the trigger switch, the faster the tool will operate. For maximum tool life, use variable speed only for starting holes or fasteners.

**NOTE:** Continuous use in variable speed range is not recommended. It may damage the switch and should be avoided.

## Side Handle (fig. 1)



**WARNING:** To reduce the risk of personal injury, **ALWAYS** operate the tool with the side handle properly installed. Failure to do so may result in the side handle slipping during tool operation and subsequent loss of control. Hold tool with both hands to maximize control.

The side handle (e) clamps to the front of the gear case and may be rotated 360° to permit right- or left-hand use. Side handle must be tightened sufficiently to resist the twisting action of the tool if the accessory binds or stalls. Be sure to grip the side handle at the far end to control the tool during a stall.

To loosen side handle, rotate counterclockwise.

## Forward/Reverse Control Button (fig. 1, 2)



**WARNING:** Always wait until the motor has come to a complete standstill before changing the direction of rotation.

A forward/reverse control button (b) determines the direction of the tool and also serves as a lock off button.

To select forward rotation, release the trigger switch and depress the forward/reverse control button on the right side of the tool.

To select reverse, release the trigger switch and depress the forward/reverse control button on the left side of the tool.

The center position of the control button locks the tool in the off position. When changing the position of the control button, be sure the trigger is released.

**NOTE:** The first time the tool is run after changing the direction of rotation, you may hear a click on start up. This is normal and does not indicate a problem.

## Worklight (fig. 1)

DCH143, DCH253, DCH254

There is a worklight (d) located on the front of the tool. The worklight will be activated when the trigger switch is squeezed. The worklight is activated when the trigger switch is depressed, and will automatically turn off 20 seconds after the trigger switch is released. If the trigger switch remains depressed, the worklight will remain on.

**NOTE:** The worklight is for lighting the immediate work surface and is not intended to be used as a flashlight.

## Selecting the Operating Mode (fig. 1)



**WARNING:** Do not select the operating mode when the tool is running.

Your tool is equipped with a separate mode selector (c) to switch between rotary drilling, rotary hammering and hammering only mode.



Rotary drilling: for screwdriving and for drilling into steel, wood and plastics.



Rotary hammering: for concrete and masonry drilling.



Hammering only: for light chipping.

For rotary drilling, rotate the mode selector (c) until the arrow points to the drill bit symbol (i). For rotary hammering mode, align the arrow with the hammerdrilling symbol (j). For hammering only mode, align arrow with the hammer symbol (k).

**NOTE:** The mode selector (c) must be in rotary drilling, rotary hammering or hammering only mode at all times. There are no operable positions in between.

## Active Vibration Control (fig. 1)

The active vibration control neutralises rebound vibration from the hammer mechanism. Lowering hand and arm vibration, it allows more comfortable use for longer periods of time and extends the life of the unit.

## ENGLISH

For best vibration control, hold the tool with one hand on the main handle (h) and the other hand on the side handle (e). The hammer only needs enough pressure to engage the internal active vibration control. Applying too much pressure will not make the tool drill faster and active vibration control will not engage.

### SDS Plus® Tool Holder (fig. 5)

To insert a drill or chisel bit, insert the shank of the bit about 19 mm (3/4") into SDS Plus® tool holder (l). Push and rotate bit until it locks in place. The bit will be securely held.

To release bit, pull the sleeve (m) back and remove the bit.

### Replacing the SDS Plus® Tool Holder with the Keyless Chuck (fig. 7)

#### DCH254

1. Turn the locking collar (p) into the unlocked position and pull the SDS Plus® tool holder (l) off.
2. Push the keyless chuck (q) onto the spindle and turn the locking collar into the locking position.
3. To replace the keyless chuck with the SDS Plus® tool holder, first remove the keyless chuck the same way as the SDS Plus® tool holder was removed. Then replace the SDS Plus® tool holder the same way as the keyless chuck was replaced.



**WARNING:** Never use standard chucks in the rotary hammering mode.

### Overload Clutch

In case of jamming of a drill bit, the drive to the drill spindle is interrupted. Because of the resulting forces, always hold the tool with both hands and take a firm stance.

## OPERATION

### Instructions for Use



#### **WARNING:**

- Always observe the safety instructions and applicable regulations.
- Be aware of the location of pipework and wiring.
- Apply only a gentle pressure to the tool (approx. 5 kg). Excessive force does not speed up drilling but decreases tool performance and may shorten tool life.

- Do not drill or drive too deep to prevent damage to the dust cover (o).
- Always hold the tool firmly with both hands and ensure a secure stance. Always operate the tool with the side handle properly mounted.



**WARNING:** To reduce the risk of serious personal injury, turn tool off and disconnect battery pack before making any adjustments or removing/installing attachments or accessories.

### Proper Hand Position (fig. 1, 6)



**WARNING:** To reduce the risk of serious personal injury, ALWAYS use proper hand position as shown in figure 6.



**WARNING:** To reduce the risk of serious personal injury, ALWAYS hold securely in anticipation of a sudden reaction.

Proper hand position requires one hand on the main handle (h), with the other hand on the side handle (e).

### Drill Operation (fig. 1)



**WARNING:** To reduce the risk of serious personal injury, turn tool off and disconnect tool from power source before making any adjustments or removing/installing attachments or accessories.



**WARNING:** To reduce the risk of personal injury, ALWAYS ensure workpiece is anchored or clamped firmly. If drilling thin material, use a wood "back-up" block to prevent damage to the material.

#### HAMMERDRILLING (FIG. 1)

1. Set the mode selector switch (c) to the "rotary hammering" position.
2. Insert the appropriate drill bit. For best results use high quality carbide-tipped bits.
3. Adjust the side handle (e) as required.
4. Mark the spot where the hole is to be drilled.
5. Place the drill bit on the spot and switch on the tool.



**ROTARY DRILLING (FIG. 1)**

1. Set the mode selector switch (c) to the "rotary drilling" position.
2. Depending on your tool, follow either of the following instructions:
  - Fit a chuck adaptor/chuck assembly (DCH143, DCH243, DCH253). Special SDS Plus® adaptors with threaded sections are available for use with standard 10 or 13 mm chucks to enable straight shank bits to be used.
  - Replace the SDS Plus® tool holder with the keyless chuck (DCH254).
3. Proceed as described for rotary hammering.



**WARNING:** Never use standard chucks in the rotary hammering mode.

**SCREWDRIVING (FIG. 1)**

1. Set the mode selector switch (c) to the "rotary drilling" position.
2. Select the direction of rotation.
3. Depending on your tool, follow either of the following instructions:
  - Insert the special SDS Plus® screwdriving adaptor for use with hexagonal screwdriver bits (DCH143, DCH243, DCH253).
  - Replace the SDS Plus® tool holder with the keyless chuck (DCH254).
4. Insert the appropriate screwdriver bit. When driving slotted head screws always use bits with a finder sleeve.
5. Gently press the variable speed switch (a) to prevent damage to the screw head. In reverse (LH) rotation the tool speed is automatically reduced for easy screw removal.
6. When the screw is flush with the workpiece, release the variable speed switch to prevent the screw head from penetrating into the workpiece.

**CHIPPING (FIG. 1)**

1. Set the mode selector switch (c) to the "hammering only" position.
2. Insert the appropriate chisel and check if it is properly locked.
3. Adjust the side handle (e) as required.
4. Switch on the tool and start working.

It may be necessary to briefly run the motor after having changed from chiselling to rotary modes in order to align the gears.

**WARNING:**

- Do not use this tool to mix or pump easily combustible or explosive fluids (benzine, alcohol, etc.).
- Do not mix or stir inflammable liquids labelled accordingly.

**MAINTENANCE**

Your DEWALT power tool has been designed to operate over a long period of time with a minimum of maintenance. Continuous satisfactory operation depends upon proper tool care and regular cleaning.



**WARNING:** To reduce the risk of serious personal injury, turn tool off and disconnect battery pack before making any adjustments or removing/installing attachments or accessories. An accidental start-up can cause injury.

This machine is not user-serviceable. Take the tool to an authorised DEWALT repair agent after approximately 40 hours of use. If problems occur before this time contact an authorised DEWALT repair agent.

The charger and battery pack are not serviceable. There are no serviceable parts inside.

**Lubrication**

Your power tool requires no additional lubrication.

**Cleaning**

**WARNING:** Blow dirt and dust out of the main housing with dry air as often as dirt is seen collecting in and around the air vents. Wear approved eye protection and approved dust mask when performing this procedure.



**WARNING:** Never use solvents or other harsh chemicals for cleaning the non-metallic parts of the tool. These chemicals may weaken the materials used in these parts. Use a cloth dampened only with water and mild soap. Never let any liquid get inside the tool; never immerse any part of the tool into a liquid.

## ENGLISH

### CHARGER CLEANING INSTRUCTIONS



**WARNING:** Shock hazard. Disconnect the charger from the AC outlet before cleaning. Dirt and grease may be removed from the exterior of the charger using a cloth or soft non-metallic brush. Do not use water or any cleaning solutions.

### Optional Accessories



**WARNING:** Since accessories, other than those offered by DEWALT, have not been tested with this product, use of such accessories with this tool could be hazardous. To reduce the risk of injury, only DEWALT recommended accessories should be used with this product.

Various types of SDS Plus® drill bits and chisels are available as an option.

Accessories and attachments used must be regularly lubricated around the SDS Plus® fitment.

Consult your dealer for further information on the appropriate accessories.

### Protecting the Environment



Separate collection. This product must not be disposed of with normal household waste.

Should you find one day that your DEWALT product needs replacement, or if it is of no further use to you, do not dispose of it with household waste. Make this product available for separate collection.



Separate collection of used products and packaging allows materials to be recycled and used again. Re-use of recycled materials helps prevent environmental pollution and reduces the demand for raw materials.

Local regulations may provide for separate collection of electrical products from the household, at municipal waste sites or by the retailer when you purchase a new product.

DEWALT provides a facility for the collection and recycling of DEWALT products once they have reached the end of their working life. To take advantage of this service please return your product to any authorised repair agent who will collect them on our behalf.

You can check the location of your nearest authorised repair agent by contacting your local DEWALT office at the address indicated in this manual. Alternatively, a list of authorised DEWALT repair agents and full details of our after-sales service and contacts are available on the Internet at: [www.2helpU.com](http://www.2helpU.com).



### Rechargeable Battery Pack

This long life battery pack must be recharged when it fails to produce sufficient power on jobs which were easily done before. At the end of its technical life, discard it with due care for our environment:

- Run the battery pack down completely, then remove it from the tool.
- Li-Ion cells are recyclable. Take them to your dealer or a local recycling station. The collected battery packs will be recycled or disposed of properly.

## GUARANTEE

DEWALT is confident of the quality of its products and offers an outstanding guarantee for professional users of the product. This guarantee statement is in addition to and in no way prejudices your contractual rights as a professional user or your statutory rights as a private non-professional user. The guarantee is valid within the territories of the Member States of the European Union and the European Free Trade Area.

### • 30 DAY NO RISK SATISFACTION GUARANTEE •

If you are not completely satisfied with the performance of your DEWALT tool, simply return it within 30 days, complete with all original components, as purchased, to the point of purchase, for a full refund or exchange. The product must have been subject to fair wear and tear and proof of purchase must be produced.

### • ONE YEAR FREE SERVICE CONTRACT •

If you need maintenance or service for your DEWALT tool, in the 12 months following purchase, you are entitled to one service free of charge. It will be undertaken free of charge at an authorised DEWALT repair agent. Proof of purchase must be produced. Includes labour. Excludes accessories and spare parts unless failed under warranty.

### • ONE YEAR FULL WARRANTY •

If your DEWALT product becomes defective due to faulty materials or workmanship within 12 months from the date of purchase, DEWALT guarantees to replace all defective parts free of charge or – at our discretion – replace the unit free of charge provided that:

- The product has not been misused;
- The product has been subject to fair wear and tear;
- Repairs have not been attempted by unauthorised persons;
- Proof of purchase is produced;
- The product is returned complete with all original components.

If you wish to make a claim, contact your seller or check the location of your nearest authorised DEWALT repair agent in the DEWALT catalogue or contact your DEWALT office at the address indicated in this manual. A list of authorised DEWALT repair agents and full details of our after-sales service is available on the Internet at: [www.2helpU.com](http://www.2helpU.com).

<b>Belgique et Luxembourg België en Luxemburg</b>	Black & Decker - DEWALT Nieuwlandlaan 7, IZ Aarschot B156 B-3200 Aarschot	Dutch Tel: 32 70 220 063 French Tel:32 70 220 062	Fax: 32 70 225 585 32 70 222 441 www.dewalt.be
<b>Danmark</b>	DEWALT Sluseholmen 2-4 2450 København SV		Tlf: 70201511 Fax: 70224910 www.dewalt.dk
<b>Deutschland</b>	DEWALT Richard Klinger Str. 11 65510 Idstein		Tel: 06126-21-1 Fax: 06126-21-2770 www.dewalt.de
<b>Ελλάς</b>	Black & Decker (Ελλάς) A.E. Στράβωνος 7 & Βουλιαγμένης 159 Γλυφάδα 16674, Αθήνα	Τηλ: 30 210 8981-616 Service: 30 210 8981-616 Φαξ: 30 210 8983-570	www.dewalt.gr
<b>España</b>	DEWALT Parque de Negocios "Mas Blau" Edificio Muntadas, c/Bergadà, 1, Of. A6 08820 El Prat de Llobregat (Barcelona)		Tel: 934 797 400 Fax: 934 797 419 www.dewalt.es
<b>France</b>	DEWALT 5, allée des hêtres BP 30084, 69579 Limonest Cedex		Tel: 04 72 20 39 20 Fax: 04 72 20 39 00 www.dewalt.fr
<b>Schweiz Suisse Svizzera</b>	DEWALT In der Luberzen 42 8902 Urdorf		Tel: 044 - 755 60 70 Fax: 044 - 730 70 67 www.dewalt.ch
<b>Ireland</b>	DEWALT Calpe House Rock Hill Black Rock, Co. Dublin		Tel: 00353-2781800 Fax: 00353-2781811 www.dewalt.ie
<b>Italia</b>	DEWALT c/o Energypark Building 03 sud, Via Monza 7/A, 20871 Vimercate (MB), IT		Tel: 800-014353 Fax: 39 039 9590 317 www.dewalt.it
<b>Nederlands</b>	Black & Decker - DEWALT Joulehof 12 4600 AB Bergen Op Zoom		Tel: 31 164 283 063 Fax: 31 164 283 200 www.dewalt.nl
<b>Norge</b>	DEWALT Postboks 4613, Nydalen 0405 Oslo		Tel: 45 25 13 00 Fax: 45 25 08 00 www.dewalt.no
<b>Österreich</b>	DEWALT Werkzeug Vertriebsges m.b.H Oberlaaerstrasse 248 A-1230 Wien		Tel: 01 - 66116 - 0 Fax: 01 - 66116 - 14 www.dewalt.at
<b>Portugal</b>	DEWALT Centro de Escritórios de Sintra Avenida Almirante Gago Coutinho, 132/134, Edifício 142710-418 Sintra 2710-418 Lisboa		Tel: 214 66 75 00 Fax: 214 66 75 75 www.dewalt.pt
<b>Suomi</b>	DEWALT Teknikantie 12 02150 Espoo, Finland		Puh: 010 400 430 Faksi: 0800 411 340 www.dewalt.fi
<b>Sverige</b>	DEWALT Box 94 431 22 Mölndal		Tel: 031 68 61 00 Fax: 031 68 60 08 www.dewalt.se
<b>Türkiye</b>	KALE Hirdavat ve Makina A.Ş. Defterdar Mah. Savaklar Cad. No:15 Edirnekapı / Eyüp / İSTANBUL 34050 TÜRKİYE		Tel: 0212 533 52 55 Faks: 0212 533 10 05 www.dewalt.com.tr
<b>United Kingdom</b>	DEWALT 210 Bath Road; Slough, Berks SL1 3YD	Tel: 01753-56 70 55 Fax: 01753-57 21 12	www.dewalt.co.uk
<b>Middle East Africa</b>	DEWALT P.O. Box - 17164, Jebel Ali (South Zone), Dubai, UAE		Tel: 971 4 8863030 Fax: 971 4 8863333 www.dewalt.ae