

DEWALT®

www.DEWALT.com

DWE496

DWE497

Figure A

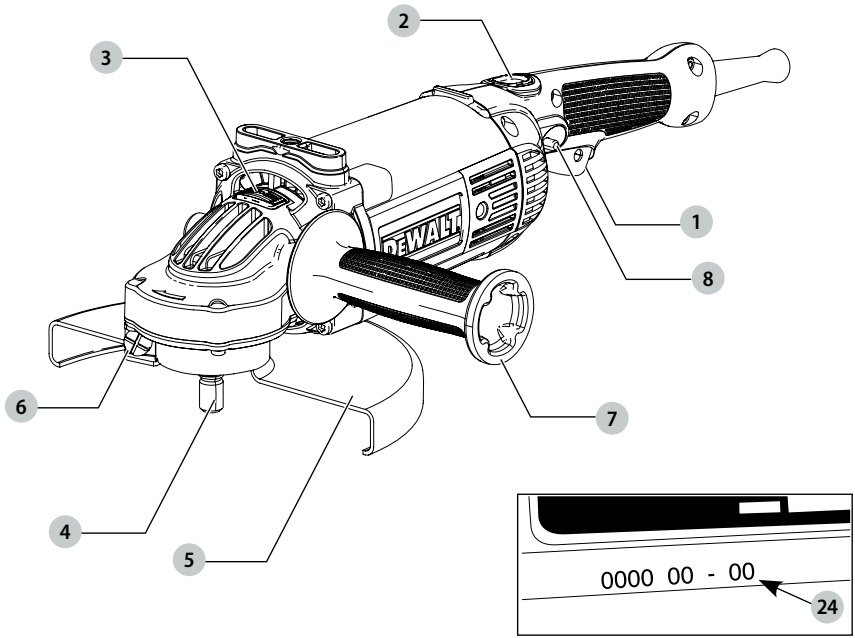

Figure B

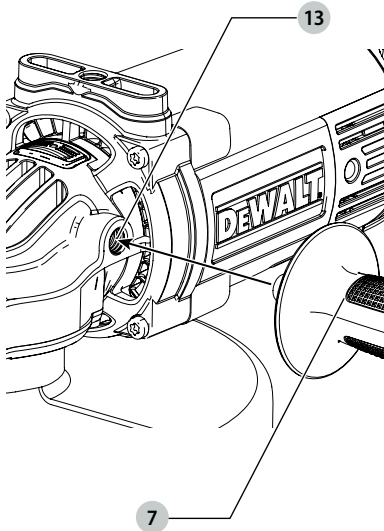

Figure C

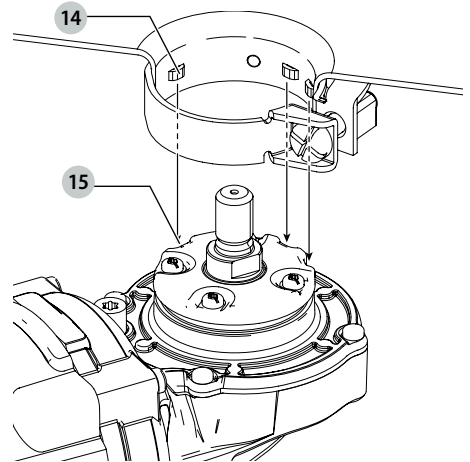

Figure D

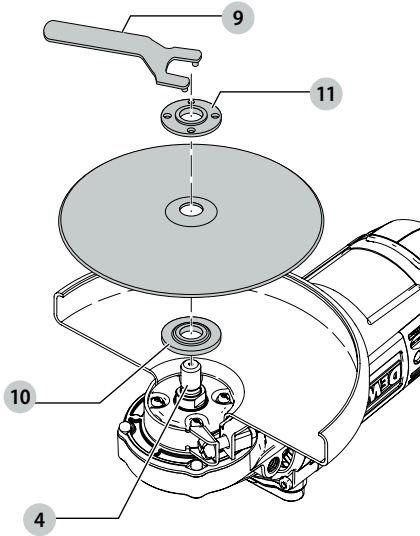

Figure E

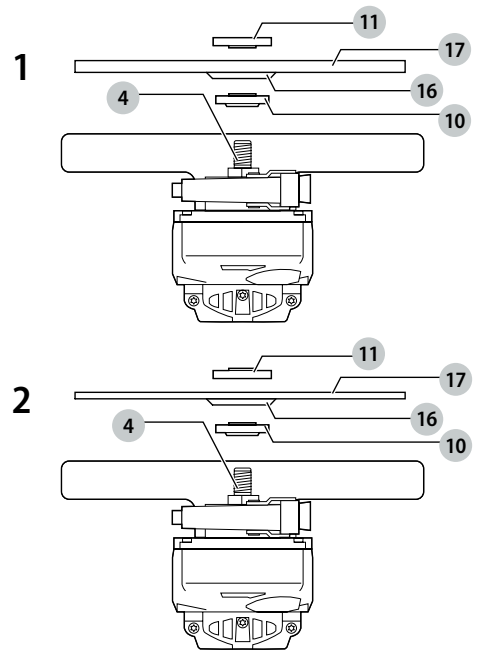

Figure Ff

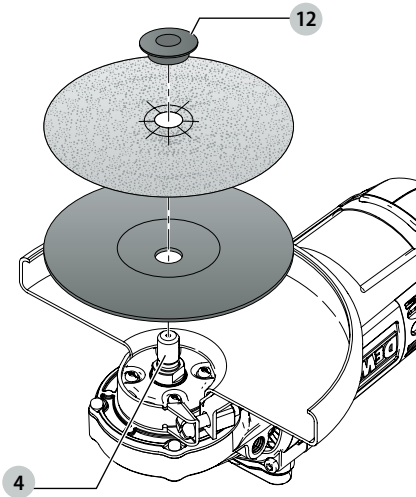
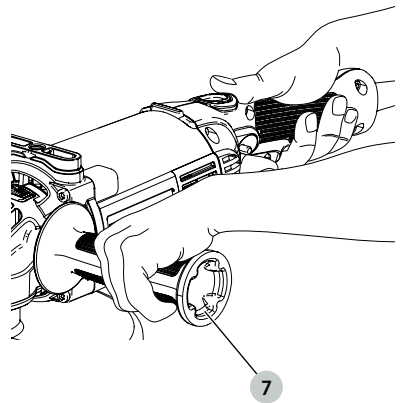

Figure G



LARGE ANGLE GRINDER

DWE496, DWE497

Congratulations!

You have chosen a DeWALT tool. Years of experience, thorough product development and innovation make DeWALT one of the most reliable partners for professional power tool users.

Technical Data

			DWE496	DWE497
Voltage	V _{AC}	B5/IN/B1	220-240	220-240
		ZA	230	230
Frequency	Hz	B5/IN/B1	50/60	50/60
		ZA	50	50
Power input	W		2600	2600
No-load/rated speed	min ⁻¹		6500	8500
Wheel diameter	mm		230	180
Spindle diameter			M14	M14
Spindle length	mm		19	19
Weight	kg		5.4	5.4

Definitions: Safety Guidelines

The definitions below describe the level of severity for each signal word. Please read the manual and pay attention to these symbols.



DANGER: Indicates an imminently hazardous situation which, if not avoided, **will** result in **death or serious injury**.



WARNING: Indicates a potentially hazardous situation which, if not avoided, **could** result in **death or serious injury**.



CAUTION: Indicates a potentially hazardous situation which, if not avoided, **may** result in **minor or moderate injury**.

NOTICE: Indicates a practice **not related to personal injury** which, if not avoided, **may** result in **property damage**.



Denotes risk of electric shock.



Denotes risk of fire.



WARNING: To reduce the risk of injury, read the instruction manual.

General Power Tool Safety Warnings



WARNING: Read all safety warnings and all instructions. Failure to follow the warnings and instructions may result in electric shock, fire and/or serious injury.

SAVE ALL WARNINGS AND INSTRUCTIONS FOR FUTURE REFERENCE

The term "power tool" in the warnings refers to your mains-operated (corded) power tool or battery-operated (cordless) power tool.

1) Work area safety

- Keep work area clean and well lit.** Cluttered or dark areas invite accidents.
- Do not operate power tools in explosive atmospheres, such as in the presence of flammable liquids, gases or dust.** Power tools create sparks which may ignite the dust or fumes.
- Keep children and bystanders away while operating a power tool.** Distractions can cause you to lose control.

2) Electrical safety

- Power tool plugs must match the outlet. Never modify the plug in any way. Do not use any adapter plugs with earthed (grounded) power tools.** Unmodified plugs and matching outlets will reduce risk of electric shock.
- Avoid body contact with earthed or grounded surfaces such as pipes, radiators, ranges and refrigerators.** There is an increased risk of electric shock if your body is earthed or grounded.
- Do not expose power tools to rain or wet conditions.** Water entering a power tool will increase the risk of electric shock.
- Do not abuse the cord. Never use the cord for carrying, pulling or unplugging the power tool. Keep cord away from heat, oil, sharp edges or moving parts.** Damaged or entangled cords increase the risk of electric shock.
- When operating a power tool outdoors, use an extension cord suitable for outdoor use.** Use of a cord suitable for outdoor use reduces the risk of electric shock.
- If operating a power tool in a damp location is unavoidable, use a residual current device (RCD) protected supply.** Use of an RCD reduces the risk of electric shock.

3) Personal safety

- Stay alert, watch what you are doing and use common sense when operating a power tool. Do not use a power tool while you are tired or under the influence of drugs, alcohol or medication.** A moment of inattention while operating power tools may result in serious personal injury.
- Use personal protective equipment. Always wear eye protection.** Protective equipment such as dust mask, non-skid safety shoes, hard hat, or hearing protection used for appropriate conditions will reduce personal injuries.

- c) **Prevent unintentional starting. Ensure the switch is in the off position before connecting to power source and/or battery pack, picking up or carrying the tool.** Carrying power tools with your finger on the switch or energising power tools that have the switch on invites accidents.
- d) **Remove any adjusting key or wrench before turning the power tool on.** A wrench or a key left attached to a rotating part of the power tool may result in personal injury.
- e) **Do not overreach. Keep proper footing and balance at all times.** This enables better control of the power tool in unexpected situations.
- f) **Dress properly. Do not wear loose clothing or jewellery. Keep your hair, clothing and gloves away from moving parts.** Loose clothes, jewellery or long hair can be caught in moving parts.
- g) **If devices are provided for the connection of dust extraction and collection facilities, ensure these are connected and properly used.** Use of dust collection can reduce dust-related hazards.

4) Power tool use and care

- a) **Do not force the power tool. Use the correct power tool for your application.** The correct power tool will do the job better and safer at the rate for which it was designed.
- b) **Do not use the power tool if the switch does not turn it on and off.** Any power tool that cannot be controlled with the switch is dangerous and must be repaired.
- c) **Disconnect the plug from the power source and/or the battery pack from the power tool before making any adjustments, changing accessories, or storing power tools.** Such preventive safety measures reduce the risk of starting the power tool accidentally.
- d) **Store idle power tools out of the reach of children and do not allow persons unfamiliar with the power tool or these instructions to operate the power tool.** Power tools are dangerous in the hands of untrained users.
- e) **Maintain power tools. Check for misalignment or binding of moving parts, breakage of parts and any other condition that may affect the power tool's operation. If damaged, have the power tool repaired before use.** Many accidents are caused by poorly maintained power tools.
- f) **Keep cutting tools sharp and clean.** Properly maintained cutting tools with sharp cutting edges are less likely to bind and are easier to control.
- g) **Use the power tool, accessories and tool bits etc., in accordance with these instructions taking into account the working conditions and the work to be performed.** Use of the power tool for operations different from those intended could result in a hazardous situation.

5) Service

- a) **Have your power tool serviced by a qualified repair person using only identical replacement parts.** This will ensure that the safety of the power tool is maintained.

ADDITIONAL SPECIFIC SAFETY RULES FOR LARGE ANGLE GRINDERS

Safety Instructions for All Operations

- a) **This power tool is intended to function as a grinder, sander, wire brush or cut-off tool. Read all safety warnings, instructions, illustrations and specifications provided with this power tool.** Failure to follow all instructions listed below may result in electric shock, fire and/or serious injury.
- b) **Operation such as polishing is not recommended to be performed with this power tool.** Operations for which the power tool was not designed may create a hazard and cause personal injury.
- c) **Do not use accessories which are not specifically designed and recommended by the tool manufacturer.** Just because the accessory can be attached to your power tool, it does not assure safe operation.
- d) **The rated speed of the accessory must be at least equal to the maximum speed marked on the power tool.** Accessories running faster than their rated speed can break and fly apart.
- e) **The outside diameter and the thickness of your accessory must be within the capacity rating of your power tool.** Incorrectly sized accessories cannot be adequately guarded or controlled.
- f) **Threaded mounting of accessories must match the grinder spindle thread. For accessories mounted by flanges, the arbour hole of the accessory must fit the locating diameter of the flange.** Accessories that do not match the mounting hardware of the power tool will run out of balance, vibrate excessively and may cause loss of control.
- g) **Do not use a damaged accessory. Before each use inspect the accessory such as abrasive wheel for chips and cracks, backing pad for cracks, tear or excess wear, wire brush for loose or cracked wires. If power tool or accessory is dropped, inspect for damage or install an undamaged accessory. After inspecting and installing an accessory, position yourself and bystanders away from the plane of the rotating accessory and run the power tool at maximum no-load speed for one minute.** Damaged accessories will normally break apart during this test time.
- h) **Wear personal protective equipment. Depending on application, use face shield, safety goggles or safety glasses. As appropriate, wear dust mask, hearing protectors, gloves and workshop apron capable of stopping small abrasive or workpiece fragments.** The eye protection must be capable of stopping flying

debris generated by various operations. The dust mask or respirator must be capable of filtering particles generated by your operation. Prolonged exposure to high intensity noise may cause hearing loss.

- i) **Keep bystanders a safe distance away from work area. Anyone entering the work area must wear personal protective equipment.** Fragments of workpiece or of a broken accessory may fly away and cause injury beyond immediate area of operation.
- j) **Hold power tool by insulated gripping surfaces only, when performing an operation where the cutting accessory may contact hidden wiring or its own cord.** Cutting accessory contacting a "live" wire may make exposed metal parts of the power tool "live" and could give the operator an electrical shock.
- k) **Position the cord clear of the spinning accessory.** If you lose control, the cord may be cut or snagged and your hand or arm may be pulled into the spinning accessory.
- l) **Never lay the power tool down until the accessory has come to a complete stop.** The spinning accessory may grab the surface and pull the power tool out of your control.
- m) **Do not run the power tool while carrying it at your side.** Accidental contact with the spinning accessory could snag your clothing, pulling the accessory into your body.
- n) **Regularly clean the power tool's air vents.** The motor's fan will draw the dust inside the housing and excessive accumulation of powdered metal may cause electrical hazards.
- o) **Do not operate the power tool near flammable materials.** Sparks could ignite these materials.
- p) **Do not use accessories that require liquid coolants.** Using water or other liquid coolants may result in electrocution or shock.

FURTHER SAFETY INSTRUCTIONS FOR ALL OPERATIONS

Causes and Operator Prevention of Kickback

Kickback is a sudden reaction to a pinched or snagged rotating wheel, backing pad, brush or any other accessory. Pinching or snagging causes rapid stalling of the rotating accessory which in turn causes the uncontrolled power tool to be forced in the direction opposite of the accessory's rotation at the point of the binding.

For example, if an abrasive wheel is snagged or pinched by the workpiece, the edge of the wheel that is entering into the pinch point can dig into the surface of the material causing the wheel to climb out or kick out. The wheel may either jump toward or away from the operator, depending on direction of the wheel's movement at the point of pinching. Abrasive wheels may also break under these conditions.

Kickback is the result of power tool misuse and/or incorrect operating procedures or conditions and can be avoided by taking proper precautions as given below:

- a) **Maintain a firm grip on the power tool and position your body and arm to allow you to resist kickback forces. Always use auxiliary handle, if provided, for maximum control over kickback or torque reaction during start up.** The operator can control torque reaction or kickback forces, if proper precautions are taken.
- b) **Never place your hand near the rotating accessory.** Accessory may kickback over your hand.
- c) **Do not position your body in the area where power tool will move if kickback occurs.** Kickback will propel the tool in direction opposite to the wheel's movement at the point of snagging.
- d) **Use special care when working corners, sharp edges etc. Avoid bouncing and snagging the accessory.** Corners, sharp edges or bouncing have a tendency to snag the rotating accessory and cause loss of control or kickback.
- e) **Do not attach a saw chain woodcarving blade or toothed saw blade.** Such blades create frequent kickback and loss of control.

Safety Warnings Specific for Grinding and Abrasive Cutting-Off Operations

- a) **Use only wheel types that are recommended for your power tool and the specific guard designed for the selected wheel.** Wheels for which the power tool was not designed cannot be adequately guarded and are unsafe.
- b) **The grinding surface of centre depressed wheels must be mounted below the plane of the guard lip.** An improperly mounted wheel that projects through the plane of the guard lip cannot be adequately protected.
- c) **The guard must be securely attached to the power tool and positioned for maximum safety, so the least amount of wheel is exposed towards the operator.** The guard helps to protect the operator from broken wheel fragments, accidental contact with wheel and sparks that could ignite clothing.
- d) **Wheels must be used only for recommended applications. For example: do not grind with the side of cut-off wheel.** Abrasive cut-off wheels are intended for peripheral grinding, side forces applied to these wheels may cause them to shatter.
- e) **Always use undamaged wheel flanges that are of correct size and shape for your selected wheel. Proper wheel flanges support the wheel thus reducing the possibility of wheel breakage.** Flanges for cut-off wheels may be different from grinding wheel flanges.
- f) **Do not use worn down wheels from larger power tools.** Wheel intended for larger power tool is not suitable for the higher speed of a smaller tool and may burst.

Additional Safety Warnings Specific for Abrasive Cutting-Off Operations

- a) **Do not “jam” the cut-off wheel or apply excessive pressure. Do not attempt to make an excessive depth of cut.** Overstressing the wheel increases the loading and susceptibility to twisting or binding of the wheel in the cut and the possibility of kickback or wheel breakage.
- b) **Do not position your body in line with and behind the rotating wheel.** When the wheel, at the point of operations, is moving away from your body, the possible kickback may propel the spinning wheel and the power tool directly at you.
- c) **When wheel is binding or when interrupting a cut for any reason, switch off the power tool and hold the power tool motionless until the wheel comes to a complete stop. Never attempt to remove the cut-off wheel from the cut while the wheel is in motion otherwise kickback may occur.** Investigate and take corrective action to eliminate the cause of wheel binding.
- d) **Do not restart the cutting operation in the workpiece. Let the wheel reach full speed and carefully reenter the cut.** The wheel may bind, walk up or kickback if the power tool is restarted in the workpiece.
- e) **Support panels or any oversized workpiece to minimize the risk of wheel pinching and kickback. Large workpieces tend to sag under their own weight.** Supports must be placed under the workpiece near the line of cut and near the edge of the workpiece on both sides of the wheel.
- f) **Use extra caution when making a “pocket cut” into existing walls or other blind areas.** The protruding wheel may cut gas or water pipes, electrical wiring or objects that can cause kickback.

Safety Warnings Specific for Sanding Operations

- a) **Do not use excessively oversized sanding disc paper. Follow manufacturer’s recommendations, when selecting sanding paper.** Larger sanding paper extending beyond the sanding pad presents a laceration hazard and may cause snagging, tearing of the disc or kickback.

Safety Warnings Specific for Wire Brushing Operations

- a) **Be aware that wire bristles are thrown by the brush even during ordinary operation. Do not overstress the wires by applying excessive load to the brush.** The wire bristles can easily penetrate light clothing and/or skin.
- b) **If the use of a guard is recommended for wire brushing, do not allow any interference of the wire wheel or brush with the guard.** Wire wheel or brush may expand in diameter due to work load and centrifugal forces.

Additional Safety Rules for Grinders

- **Do not use Type 11 (flaring cup) wheels on this tool.** Using inappropriate accessories can result in injury.
- **Always use side handle. Tighten the handle securely.** The side handle should always be used to maintain control of the tool at all times.



WARNING: We recommend the use of a residual current device with a residual current rating of 30mA or less.

Residual Risks

In spite of the application of the relevant safety regulations and the implementation of safety devices, certain residual risks cannot be avoided. These are:

- Impairment of hearing.
- Risk of personal injury due to flying particles.
- Risk of burns due to accessories becoming hot during operation.
- Risk of personal injury due to prolonged use.

Electrical Safety

The electric motor has been designed for one voltage only. Always check that the power supply corresponds to the voltage on the rating plate.



Your DeWALT tool is double insulated in accordance with IEC60745; therefore no earth wire is required.



WARNING: 127V units have to be operated via a fail-safe isolating transformer with an earth screen between the primary and secondary winding.

If the supply cord is damaged, it must be replaced by a specially prepared cord available through the DEWALT service organisation.

Mains Plug Replacement (Middle East and Africa)

If a new mains plug needs to be fitted:

- Safely dispose of the old plug.
- Connect the brown lead to the live terminal in the plug.
- Connect the blue lead to the neutral terminal.



WARNING: No connection is to be made to the earth terminal.

Follow the fitting instructions supplied with good quality plugs. Recommended fuse: 13 A.

Using an Extension Cable

An extension cord should not be used unless absolutely necessary. If an extension cable is required, use an approved 3-core extension cable suitable for the power input of this tool (see **Technical Data**). The minimum conductor size is 1.5 mm²; the maximum length is 30 m.

When using a cable reel, always unwind the cable completely.

Package Contents

The package contains:

- 1 Angle grinder

- 1 Guard
- 1 Side handle
- 1 Flange set
- 1 Two-pin spanner
- 1 Instruction manual
- Check for damage to the tool, parts or accessories which may have occurred during transport.
- Take the time to thoroughly read and understand this manual prior to operation.

Markings on Tool

The following pictograms are shown on the tool:



Read instruction manual before use.



Wear ear protection.



Wear eye protection.

Date Code Position (Fig. A)

The date code **24**, which also includes the year of manufacture, is printed into the housing.

Example:

2021 XX XX

Year of Manufacture

Description (Fig. A, D)



WARNING: Never modify the power tool or any part of it. Damage or personal injury could result.

- 1 On/off trigger
- 2 Lock-off button (B5, ZA models only)
- 3 Spindle lock
- 4 Spindle
- 5 Guard
- 6 Guard screw
- 7 Side handle
- 8 Lock-on button
- 9 Two-pin spanner
- 10 Backing flange
- 11 Threaded clamp nut

Intended Use

Your heavy-duty angle grinder has been designed for professional grinding, sanding, wire brush and cutting.

DO NOT use under wet conditions or in the presence of flammable liquids or gases.

These heavy-duty angle grinders are professional power tools.

DO NOT let children come into contact with the tool. Supervision is required when inexperienced operators use this tool.

- This product is not intended for use by persons (including children) suffering from diminished physical, sensory or

mental abilities; lack of experience, knowledge or skills unless they are supervised by a person responsible for their safety. Children should never be left alone with this product.

ASSEMBLY AND ADJUSTMENTS



WARNING: To reduce the risk of serious personal injury, turn tool off and disconnect tool from power source before making any adjustments or removing/installing attachments or accessories. An accidental start-up can cause injury.

Attaching Side Handle (Fig. B)



WARNING: Before using the tool, check that the handle is tightened securely.



WARNING: The side handle should always be used to maintain control of the tool at all times.

Screw the side handle **7** tightly into one of the holes **13** on either side of the gear case.

Mounting and Removing a Keyed Guard (Fig. A, C)



CAUTION: Guards must be used with this grinder.

When using the grinder for cutting metal or masonry a Type 1 guard MUST be used. Type 1 guards are available at extra cost from DEWALT distributors.

DO NOT use cutting functioning without a proper Type 1 guard. Misuse may result in serious injury.

NOTE: Please refer to the **Grinding and Cutting Accessory Chart** at the end of this section to show other accessories that can be used with these grinders.

1. Place the angle grinder on a table, spindle **4** up.
2. Align the lugs **14** with the notches **15**.
3. Press the guard **5** down and rotate it to the required position.
4. Securely tighten the screw **6**.
5. To remove the guard, slacken the screw.



CAUTION: If the guard cannot be tightened by the adjusting screw, do not use the tool. To reduce the risk of personal injury, take the tool and guard to a service center to repair or replace the guard.

Fitting and Removing a Grinding or Cutting Disc (Fig. A, D, E)



WARNING: Do not use a damaged disc.

1. Place the tool on a table, guard up.
2. Fit the backing flange **10** correctly onto the spindle **4** (Fig. D).
3. Place the disc **17** on the backing flange **10** (Fig. E). When fitting a disc with a raised centre, make sure that the raised centre **16** is facing the backing flange **10**.
4. Screw the threaded clamp nut **11** onto the spindle **4** (Fig. E):

- a. The ring on the threaded clamp nut **11** must face towards the disc when fitting a grinding disc (Fig. E1);
 - b. The ring on the threaded clamp nut **11** must face away from the disc when fitting a cutting disc (Fig. E2).
5. Press the spindle lock button **3** and rotate the spindle **4** until it locks in position.
 6. Tighten the threaded clamp nut **11** with the two-pin spanner supplied.
 7. Release the spindle lock.
 8. To remove the disc, loosen the threaded clamp nut **11** with the two-pin spanner.

Fitting and Removing a Backing pad/ Sanding sheet (Fig. A, D, F)

1. Place the tool on a table or flat surface, with the guard facing up.
2. Remove the backing flange **10**.
3. Place the rubber backing pad correctly onto the spindle **4**.
4. Place the sanding sheet on the rubber backing pad.
5. Screw the threaded sanding clamp nut **12** supplied with the backing pad onto the spindle. The ring on the threaded clamp nut must face towards the rubber backing pad.
6. Press the spindle lock button **3** and rotate the spindle **4** until it locks in position.
7. Tighten the threaded sanding clamp nut **12** with the two-pin spanner.
8. Release the spindle lock.
9. To remove the rubber backing pad, loosen the threaded clamp nut **12** with the two-pin spanner.

Fitting a Wire Cup Brush

Screw the wire cup brush directly onto the spindle without the use of the spacer and threaded flange.

Prior to Operation

- Install the guard and appropriate disc or wheel. Do not use excessively worn discs or wheels.
- Be sure the inner and outer flange are mounted correctly. Follow the instructions given in the **Grinding and Cutting Accessory Chart**.
- Make sure the disc or wheel rotates in the direction of the arrows on the accessory and the tool.
- Do not use a damaged accessory. Before each use inspect the accessory such as abrasive wheels for chips and cracks, backing pad for cracks, tear or excess wear, wire brush for loose or cracked wires. If power tool or accessory is dropped, inspect for damage or install an undamaged accessory. After inspecting and installing an accessory, position yourself and bystanders away from the plane of the rotating accessory and run the power tool at maximum no-load speed for one minute. Damaged accessories will normally break apart during this test time.
- Never use blotters together with bonded abrasive products.

- Do not work with the grinding cup without a suitable guard in place.
- **Do not strain the machine so heavily that it comes to a standstill. After heavily straining the power tool, continue to run it at no-load for several minutes to cool down the accessory. Do not touch grinding and cutting discs before they have cooled down.** The discs can become very hot while working.
- Do not use the power tool with a cut-off stand.

OPERATION

Instructions for Use



WARNING: Always observe the safety instructions and applicable regulations.



WARNING: To reduce the risk of serious personal injury, turn tool off and disconnect tool from power source before making any adjustments or removing/installing attachments or accessories. An accidental start-up can cause injury.





WARNING:

- Ensure all materials to be ground or cut are secured in place.
- Secure and support the workpiece. Use clamps or a vice to hold and support the workpiece to a stable platform. It is important to clamp and support the workpiece securely to prevent movement of the workpiece and loss of control. Movement of the workpiece or loss of control may create a hazard and cause personal injury.
- **Support panels or any oversized workpiece to minimize the risk of wheel pinching and kickback.** Large workpieces tend to sag under their own weight. Supports must be placed under the workpiece near the line of cut and near the edge of the workpiece on both sides of the wheel.
- Always wear regular working gloves while operating this tool.
- Apply only a gentle pressure to the tool. Do not exert side pressure on the disc.
- Avoid overloading. Should the tool become hot, let it run a few minutes under no load condition to cool the accessory. Do not touch accessories before they have cooled. The discs become very hot during use.
- Never work with the grinding cup without a suitable protection guard in place.
- Do not use the power tool with a cut-off stand.
- Never use blotters together with bonded abrasive products.
- Be aware, the wheel continues to rotate after the tools is switched off.
- The tool is not designed to be used with a grinding cup.
- Do not use separate reducing bushings or adapters to adapt large hole abrasive wheels.

Proper Hand Position (Fig. G)

 **WARNING:** To reduce the risk of serious personal injury, **ALWAYS** use proper hand position as shown.



 **WARNING:** To reduce the risk of serious personal injury, **ALWAYS** hold securely in anticipation of a sudden reaction.

Proper hand position requires one hand on the side handle , with the other hand on the body of the tool, as shown in Figure G.

Switching On and Off (Fig. A)

B5, ZA models

The on/off switch is equipped with an unlocking switch.

To run the tool, depress the lock-off button  and subsequently operate the on/off trigger .

Release the lock-off button . To stop the tool, release the switch.

IN, B1 models

To run the tool, depress the on/off trigger switch .

To stop the tool, release the on/off trigger switch.

Lock-on Button (Fig. A)

For continuous operation depress the lock-on button  and release the on/off trigger switch.

To stop the tool press the on/off switch again.

The lock-on button can be permanently removed without compromising compliance with regulatory agencies shown on the tool's nameplate. Removal of the lock pin must be done by a DeWALT Service Centre.

Spindle Lock (Fig. A)

The spindle lock  is provided to prevent the spindle from rotating when installing or removing wheels. Operate the spindle lock only when the tool is turned off, unplugged from the power supply, and has come to a complete stop.

NOTICE: To reduce the risk of damage to the tool, do not engage the spindle lock while the tool is operating. Damage to the tool will result and attached accessory may spin off possibly resulting in injury.

To engage the lock, depress the spindle lock button and rotate the spindle until you are unable to rotate the spindle further.

Metal Applications

When using the tool in metal applications, make sure that a residual current device (RCD) has been inserted to avoid residual risks caused by metal swarf.

If the power supply is shut off by the RCD, take the tool to authorised DeWALT repair agent.

 **WARNING:** In extreme working conditions, conductive dust can accumulate inside the machine housing when working with metal. This can result in the protective insulation in the machine becoming degraded with a potential risk of an electrical shock.

To avoid build-up of metal swarf inside the machine, we recommend to clear the ventilation slots on a daily basis. Refer to **Maintenance**.

Cutting Metal

For cutting with bonded abrasives, always use a protection guard type 1.

When cutting, work with moderate feed, adapted to the material being cut. Do not exert pressure onto the cutting disc, tilt or oscillate the machine.

Do not reduce the speed of running down cutting discs by applying sideward pressure.

The machine must always work in an upgrinding motion. Otherwise, the danger exists of it being pushed uncontrolled out of the cut.

When cutting profiles and square bar, it is best to start at the smallest cross section.

Rough Grinding

Never use a cutting disc for rough grinding. Always use the guard type 27.

The best roughing results are achieved when setting the machine at an angle of 30° to 40°. Move the machine back and forth with moderate pressure. In this manner, the workpiece will not become too hot, does not discolour and no grooves are formed.

Cutting Stone

The machine shall be used only for dry cutting. For cutting stone, it is best to use a diamond cutting disc. Operate the machine only with additional dust protection mask.

Working Advice

Exercise caution when cutting slots in structural walls.

Slots in structural walls are subject to the country-specific regulations. These regulations are to be observed under all circumstances. Before beginning work, consult the responsible structural engineer, architect or the construction supervisor.

Using Flap Discs

 **WARNING: Metal dust build-up.** Extensive use of flap discs in metal applications can result in the increased potential for electric shock. To reduce this risk, insert an RCD before use and clean the ventilation slots daily by blowing dry compressed air into the ventilation slots in accordance with the below maintenance instructions.

MAINTENANCE

Your DeWALT power tool has been designed to operate over a long period of time with a minimum of maintenance. Continuous satisfactory operation depends upon proper tool care and regular cleaning.

 **WARNING:** To reduce the risk of serious personal injury, turn tool off and disconnect tool from power source before making any adjustments or removing/installing attachments or accessories. An accidental start-up can cause injury.



Lubrication

Your power tool requires no additional lubrication.



Cleaning



WARNING: Blow dirt and dust out of the main housing with dry air as often as dirt is seen collecting in and around the air vents. Wear approved eye protection and approved dust mask when performing this procedure.



WARNING: Never use solvents or other harsh chemicals for cleaning the non-metallic parts of the tool. These chemicals may weaken the materials used in these parts. Use a cloth dampened only with water and mild soap. Never let any liquid get inside the tool; never immerse any part of the tool into a liquid.



Optional Accessories



WARNING: Since accessories, other than those offered by DEWALT, have not been tested with this product, use of such accessories with this tool could be hazardous. To reduce the risk of injury, only DEWALT recommended accessories should be used with this product.

Consult your dealer for further information on the appropriate accessories.

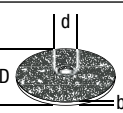
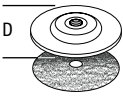
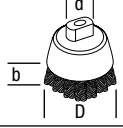
Accessory Chart

	Max. [mm]		[mm]	Min. Rotation [min. ⁻¹]	Peripheral speed [m/s]	Threaded hole length [mm]
	D	b	d			
	230	6	22,23	6500	80	—
	180	—	—	8500	80	—
	75	30	M14	8500	45	20.0
	180 230	12	M14	8500 8500	80 80	20.0 20.0

Protecting the Environment



Separate collection. Products and batteries marked with this symbol must not be disposed of with normal household waste.















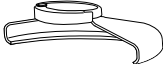
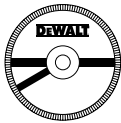



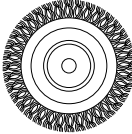

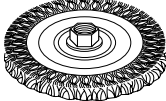
Products and batteries contain materials that can be recovered or recycled reducing the demand for raw materials. Please recycle electrical products and batteries according to local provisions. Further information is available at www.2helpU.com.

After Service and Repair

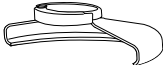

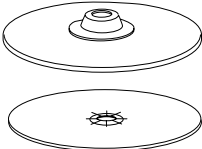
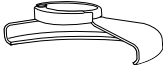

DEWALT service centers are staffed with trained personnel to provide customers with efficient and reliable product service.

We do not take any responsibility when you have repaired in unauthorized service center. You can refer to the leaflet of CONTACT CENTER LOCATOR in product package and contact us through hotline, website or social media to find the nearest DEWALT service center around you.

Grinding and Cutting Accessory Chart

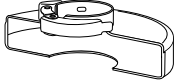
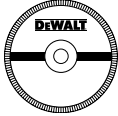
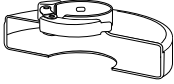
Guard Type	Accessory	Description	How to Fit Grinder
 Type 27 Guard		Depressed centre grinding disc	 Type 27 guard
		Flap wheel	 Backing flange  
		Wire wheels	Type 27 depressed centre wheel  Threaded clamp nut
		Wire wheels with threaded nut	 Type 27 guard  Wire wheel
		Wire cup with threaded nut	 Type 27 guard  Wire brush
		Backing pad/sanding sheet	 Type 27 guard  Rubber backing pad  Sanding disc  Threaded clamp nut

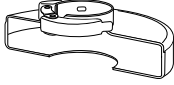
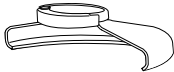
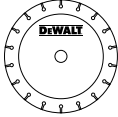
Grinding and Cutting Accessory Chart (cont.)

Guard Type	Accessory	Description	How to Fit Grinder
 Type 1 Guard		Masonry cutting disc, bonded	 Type 1 guard
		Metal cutting disc, bonded	 Backing flange
 Type 1 Guard OR  Type 27 Guard		Diamond cutting wheels	 Cutting wheel  Threaded clamp nut

