

DEWALT®

XR LI-ION

www.DEWALT.com

DCMAS5713

English (*original instructions*)

3

简体中文

12

Fig. A
图A

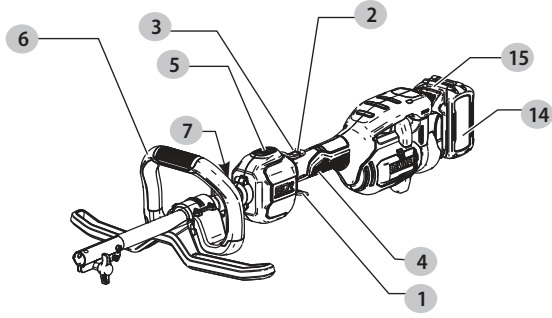

Fig. B
图B

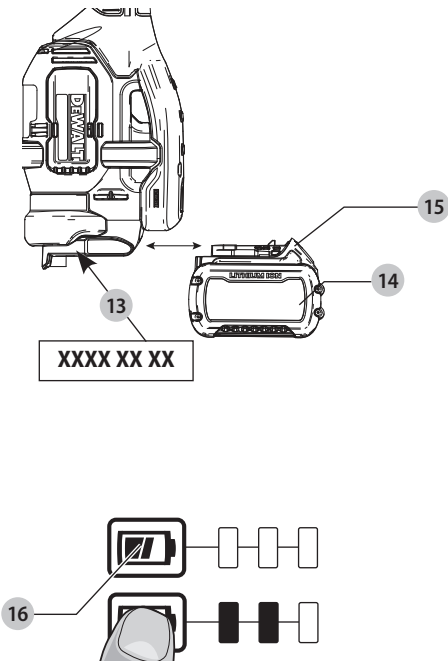

Fig. C
图C

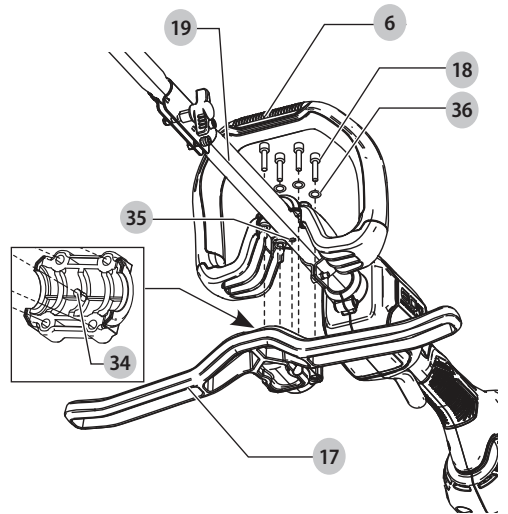

Fig. D
图D

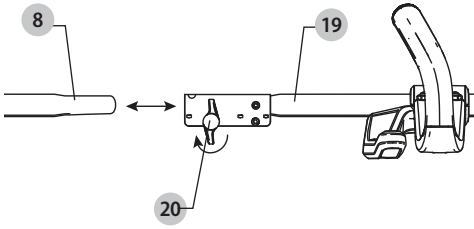

Fig. E
图E

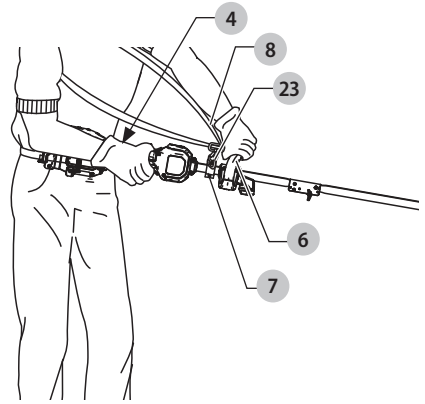

Fig. F
图F

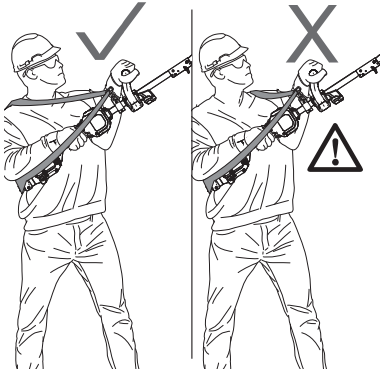
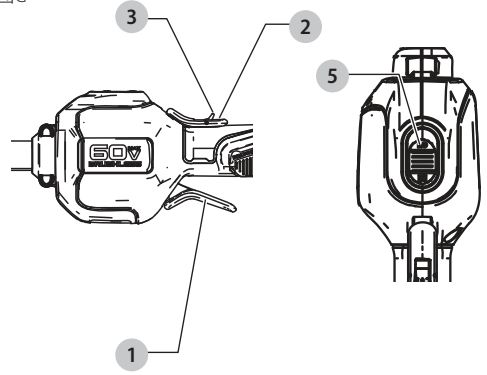

Fig. G
图G



POWER HEAD

DCMAS5713

Congratulations!

You have chosen a DEWALT tool. Years of experience, thorough product development and innovation make DEWALT one of the most reliable partners for professional power tool users.

Technical Data

DCMAS5713		
Voltage	V _{DC}	54V(60V MAX)
Weight (without battery pack)	kg	3.4



WARNING: To reduce the risk of injury, read the instruction manual.

Definitions: Safety Guidelines

The definitions below describe the level of severity for each signal word. Please read the manual and pay attention to these symbols.



DANGER: Indicates an imminently hazardous situation which, if not avoided, **will** result in **death or serious injury**.



WARNING: Indicates a potentially hazardous situation which, if not avoided, **could** result in **death or serious injury**.



CAUTION: Indicates a potentially hazardous situation which, if not avoided, **may** result in **minor or moderate injury**.

NOTICE: Indicates a practice **not related to personal injury** which, if not avoided, **may** result in **property damage**.



Denotes risk of electric shock.



Denotes risk of fire.

Batteries				Chargers / Charge Times (Minutes)***						
Cat#	V _{DC}	Ah	Weight(kg)	DCB104	DCB107	DCB112 DCB1102	DCB115 DCB1104	DCB117 DCB1112	DCB118	DCB132
DCB546/DCB606	18/54 (20/60 Max)	6.0/2.0	1.08	60	270	170	90	40	60	90
DCB547/DCB609/DCB609G	18/54 (20/60 Max)	9.0/3.0	1.46	75*	420	270	135*	60	75*	135*
DCB548/DCB612	18/54 (20/60 Max)	12.0/4.0	1.46	120	540	350	180	80	120	180
DCB549/DCB615	18/54 (20/60 Max)	15.0/5.0	2.12	125	730	450	230	90	125	230
DCB180	18 (20 Max)	3.0	0.62	45	140	90	45	45	45	45
DCB181	18 (20 Max)	1.5	0.35	22	70	45	22	22	22	22
DCB182/DCB204	18 (20 Max)	4.0	0.61	60/40**	185	120	60	60/40**	60/40**	60
DCB183/DCB203	18 (20 Max)	2.0	0.40	30	90	60	30	30	30	30
DCB184/DCB184G/DCB205	18 (20 Max)	5.0	0.62	75/50**	240	150	75	75/50**	75/50**	75
DCB187	18 (20 Max)	3.0	0.54	45	140	90	45	45	45	45
DCB189/DCB240	18 (20 Max)	4.0	0.54	60	185	120	60	60	60	60
DCB186	18 (20 Max)	6.0	0.95	60	270	170	90	60	60	90
DCB208	18 (20 Max)	8.0	0.95	70	360	240	120	70	70	120
DCBP034	18 (20 Max)	1.7	0.32	27	82	50	27	27	27	27
DCBP520	18 (20 Max)	5.0	0.75	75/50**	240	150	75	75/50**	75/50**	75

*Date code 201811475B or later

**Date code 201536 or later

***Battery charge times matrix provided for guidance only; charge times will vary depending on temperature and condition of batteries.

GENERAL POWER TOOL SAFETY WARNINGS



WARNING: Read all safety warnings, instructions, illustrations and specifications provided with this power tool. Failure to follow all instructions listed below may result in electric shock, fire and/or serious injury.

SAVE ALL WARNINGS AND INSTRUCTIONS FOR FUTURE REFERENCE

The term "power tool" in the warnings refers to your mains-operated (corded) power tool or battery-operated (cordless) power tool.

1) Work Area Safety

- a) **Keep work area clean and well lit.** Cluttered or dark areas invite accidents.
- b) **Do not operate power tools in explosive atmospheres, such as in the presence of flammable liquids, gases or dust.** Power tools create sparks which may ignite the dust or fumes.
- c) **Keep children and bystanders away while operating a power tool.** Distractions can cause you to lose control.

2) Electrical Safety

- a) **Power tool plugs must match the outlet. Never modify the plug in any way. Do not use any adapter plugs with earthed (grounded) power tools.**
Unmodified plugs and matching outlets will reduce risk of electric shock.
- b) **Avoid body contact with earthed or grounded surfaces, such as pipes, radiators, ranges and refrigerators.** There is an increased risk of electric shock if your body is earthed or grounded.
- c) **Do not expose power tools to rain or wet conditions.** Water entering a power tool will increase the risk of electric shock.
- d) **Do not abuse the cord. Never use the cord for carrying, pulling or unplugging the power tool. Keep cord away from heat, oil, sharp edges or moving parts.** Damaged or entangled cords increase the risk of electric shock.
- e) **When operating a power tool outdoors, use an extension cord suitable for outdoor use.** Use of a cord suitable for outdoor use reduces the risk of electric shock.
- f) **If operating a power tool in a damp location is unavoidable, use a residual current device (RCD) protected supply.** Use of an RCD reduces the risk of electric shock.

3) Personal Safety

- a) **Stay alert, watch what you are doing and use common sense when operating a power tool. Do not use a power tool while you are tired or under the influence of drugs, alcohol or medication.** A moment of inattention while operating power tools may result in serious personal injury.
- b) **Use personal protective equipment. Always wear eye protection.** Protective equipment such as a dust mask, non-skid safety shoes, hard hat or hearing protection used for appropriate conditions will reduce personal injuries.

- c) **Prevent unintentional starting. Ensure the switch is in the off-position before connecting to power source and/or battery pack, picking up or carrying the tool.** Carrying power tools with your finger on the switch or energising power tools that have the switch on invites accidents.
- d) **Remove any adjusting key or wrench before turning the power tool on.** A wrench or a key left attached to a rotating part of the power tool may result in personal injury.
- e) **Do not overreach. Keep proper footing and balance at all times.** This enables better control of the power tool in unexpected situations.
- f) **Dress properly. Do not wear loose clothing or jewellery. Keep your hair and clothing away from moving parts.** Loose clothes, jewellery or long hair can be caught in moving parts.
- g) **If devices are provided for the connection of dust extraction and collection facilities, ensure these are connected and properly used.** Use of dust collection can reduce dust-related hazards.
- h) **Do not let familiarity gained from frequent use of tools allow you to become complacent and ignore tool safety principles.** A careless action can cause severe injury within a fraction of a second.

4) Power Tool Use and Care

- a) **Do not force the power tool. Use the correct power tool for your application.** The correct power tool will do the job better and safer at the rate for which it was designed.
- b) **Do not use the power tool if the switch does not turn it on and off.** Any power tool that cannot be controlled with the switch is dangerous and must be repaired.
- c) **Disconnect the plug from the power source and/or remove the battery pack, if detachable, from the power tool before making any adjustments, changing accessories, or storing power tools.** Such preventive safety measures reduce the risk of starting the power tool accidentally.
- d) **Store idle power tools out of the reach of children and do not allow persons unfamiliar with the power tool or these instructions to operate the power tool.** Power tools are dangerous in the hands of untrained users.
- e) **Maintain power tools and accessories. Check for misalignment or binding of moving parts, breakage of parts and any other condition that may affect the power tool's operation. If damaged, have the power tool repaired before use.** Many accidents are caused by poorly maintained power tools.
- f) **Keep cutting tools sharp and clean.** Properly maintained cutting tools with sharp cutting edges are less likely to bind and are easier to control.
- g) **Use the power tool, accessories and tool bits etc. in accordance with these instructions, taking into account the working conditions and the work to be performed.** Use of the power tool for operations different from those intended could result in a hazardous situation.

- h) **Keep handles and grasping surfaces dry, clean and free from oil and grease.** Slippery handles and grasping surfaces do not allow for safe handling and control of the tool in unexpected situations.

5) Battery Tool Use and Care

- a) **Recharge only with the charger specified by the manufacturer.** A charger that is suitable for one type of battery pack may create a risk of fire when used with another battery pack.
- b) **Use power tools only with specifically designated battery packs.** Use of any other battery packs may create a risk of injury and fire.
- c) **When battery pack is not in use, keep it away from other metal objects, like paper clips, coins, keys, nails, screws or other small metal objects, that can make a connection from one terminal to another.** Shorting the battery terminals together may cause burns or a fire.
- d) **Under abusive conditions, liquid may be ejected from the battery; avoid contact. If contact accidentally occurs, flush with water. If liquid contacts eyes, additionally seek medical help.** Liquid ejected from the battery may cause irritation or burns.
- e) **Do not use a battery pack or tool that is damaged or modified.** Damaged or modified batteries may exhibit unpredictable behaviour resulting in fire, explosion or risk of injury.
- f) **Do not expose a battery pack or tool to fire or excessive temperature.** Exposure to fire or temperature above 130 °C may cause explosion.
- g) **Follow all charging instructions and do not charge the battery pack or tool outside the temperature range specified in the instructions.** Charging improperly or at temperatures outside the specified range may damage the battery and increase the risk of fire.

6) Service

- a) **Have your power tool serviced by a qualified repair person using only identical replacement parts.** This will ensure that the safety of the power tool is maintained.
- b) **Never service damaged battery packs.** Service of battery packs should only be performed by the manufacturer or authorized service providers.

Safety of Others

- a) This appliance is not intended for use by persons (including children) with reduced physical, sensory or mental capabilities, or lack of experience and knowledge, unless they have been given supervision or instruction concerning use of the appliance by a person responsible for their safety.
- b) Children must be supervised to ensure that they do not play with the appliance.
- c) When the appliance is stored or transported in a vehicle it should be placed in the boot or restrained to prevent movement following sudden changes in speed or direction.

- d) When not in use, the appliance should be stored in a dry, well ventilated place out of reach of children.
- e) Children should not have access to stored appliances.

Chargers

DEWALT chargers require no adjustment and are designed to be as easy as possible to operate.

Electrical Safety

The electric motor has been designed for one voltage only. Always check that the battery pack voltage corresponds to the voltage on the rating plate. Also make sure that the voltage of your charger corresponds to that of your mains.



Your DEWALT charger is double insulated in accordance with IEC60335; therefore no earth wire is required.

If the supply cord is damaged, it must be replaced only by DEWALT or an authorised service organisation.

Using an Extension Cable

An extension cord should not be used unless absolutely necessary. Use an approved extension cable suitable for the power input of your charger (see **Technical Data**). The minimum conductor size is 1 mm²; the maximum length is 30 m.

When using a cable reel, always unwind the cable completely.

Important Safety Instructions for All Battery Chargers

SAVE THESE INSTRUCTIONS: This manual contains important safety and operating instructions for compatible battery chargers (refer to **Technical Data**).

- Before using charger, read all instructions and cautionary markings on charger, battery pack, and product using battery pack.



WARNING: Shock hazard. Do not allow any liquid to get inside charger. Electric shock may result.



WARNING: We recommend the use of a residual current device with a residual current rating of 30mA or less.



CAUTION: Burn hazard. To reduce the risk of injury, charge only DEWALT rechargeable batteries. Other types of batteries may burst causing personal injury and damage.



CAUTION: Children should be supervised to ensure that they do not play with the appliance.

NOTICE: Under certain conditions, with the charger plugged into the power supply, the exposed charging contacts inside the charger can be shorted by foreign material. Foreign materials of a conductive nature such as, but not limited to, steel wool, aluminum foil or any buildup of metallic particles should be kept away from charger cavities. Always unplug the charger from the power supply when there is no battery pack in the cavity. Unplug charger before attempting to clean.

- **DO NOT attempt to charge the battery pack with any chargers other than the ones in this manual.** The charger and battery pack are specifically designed to work together.

- **These chargers are not intended for any uses other than charging DEWALT rechargeable batteries.** Any other uses may result in risk of fire, electric shock or electrocution.
- **Do not expose charger to rain or snow.**
- **Pull by plug rather than cord when disconnecting charger.** This will reduce risk of damage to electric plug and cord.
- **Make sure that cord is located so that it will not be stepped on, tripped over, or otherwise subjected to damage or stress.**
- **Do not use an extension cord unless it is absolutely necessary.** Use of improper extension cord could result in risk of fire, electric shock, or electrocution.
- **Do not place any object on top of charger or place the charger on a soft surface that might block the ventilation slots and result in excessive internal heat.**
Place the charger in a position away from any heat source. The charger is ventilated through slots in the top and the bottom of the housing.
- **Do not operate charger with damaged cord or plug—** have them replaced immediately.
- **Do not operate charger if it has received a sharp blow, been dropped, or otherwise damaged in any way.** Take it to an authorised service centre.
- **Do not disassemble charger; take it to an authorised service centre when service or repair is required.** Incorrect reassembly may result in a risk of electric shock, electrocution or fire.
- *In case of damaged power supply cord, the supply cord must be replaced immediately by the manufacturer, its service agent or similar qualified person to prevent any hazard.*
- **Disconnect the charger from the outlet before attempting any cleaning.** This will reduce the risk of electric shock. Removing the battery pack will not reduce this risk.
- **NEVER** attempt to connect two chargers together.
- **The charger is designed to operate on standard 220V-240V household electrical power. Do not attempt to use it on any other voltage.** This does not apply to the vehicular charger.













Charging a Battery (Fig. B)

1. Plug the charger into an appropriate outlet before inserting battery pack.
2. Insert the battery pack **14** into the charger, making sure the battery pack is fully seated in the charger. The red (charging) light will blink repeatedly indicating that the charging process has started.
3. The completion of charge will be indicated by the red light remaining ON continuously. The battery pack is fully charged and may be used at this time or left in the charger. To remove the battery pack from the charger, push the battery release button **15** on the battery pack.

NOTE: To ensure maximum performance and life of lithium-ion battery packs, charge the battery pack fully before first use.

Charger Operation

Refer to the indicators below for the charge status of the battery pack.

Indicators			
	Stage 1 Charging		
	Stage 2 Charging		
	Fully Charged		
	Hot/Cold Pack Delay*		

*The red light will continue to blink, but a yellow indicator light will be illuminated during this operation. Once the battery pack has reached an appropriate temperature, the yellow light will turn off and the charger will resume the charging procedure. The compatible charger(s) will not charge a faulty battery pack. The charger will indicate faulty battery by refusing to light.

NOTE: This could also mean a problem with a charger.

If the charger indicates a problem, take the charger and battery pack to be tested at an authorised service centre.

Hot/Cold Pack Delay

When the charger detects a battery pack that is too hot or too cold, it automatically starts a Hot/Cold Pack Delay, suspending charging until the battery pack has reached an appropriate temperature. The charger then automatically switches to the pack charging mode. This feature ensures maximum battery pack life.

A cold battery pack will charge at a slower rate than a warm battery pack. The battery pack will charge at that slower rate throughout the entire charging cycle and will not return to maximum charge rate even if the battery pack warms.

Electronic Protection System

XR Li-Ion tools are designed with an Electronic Protection System that will protect the battery pack against overloading, overheating or deep discharge.

The tool will automatically turn off if the Electronic Protection System engages. If this occurs, place the lithium-ion battery pack on the charger until it is fully charged.

Wall Mounting

These chargers are designed to be wall mountable or to sit upright on a table or work surface. If wall mounting, locate the charger within reach of an electrical outlet, and away from a corner or other obstructions which may impede air flow. Use the back of the charger as a template for the location of the mounting screws on the wall. Mount the charger securely using drywall screws (purchased separately) at least 25.4 mm long with a screw head diameter of 7–9 mm, screwed into wood to an optimal depth leaving approximately 5.5 mm of the screw exposed. Align the slots on the back of the charger with the exposed screws and fully engage them in the slots.

Charger Cleaning Instructions



WARNING: Shock hazard. Disconnect the charger from the AC outlet before cleaning. Dirt and grease may be removed from the exterior of the charger using a cloth or soft non-metallic brush. Do not use water or any cleaning solutions. Never let any liquid get inside the tool; never immerse any part of the tool into a liquid.

Battery Packs

Important Safety Instructions for All Battery Packs

When ordering replacement battery packs, be sure to include catalogue number and voltage.

The battery pack is not fully charged out of the carton. Before using the battery pack and charger, read the safety instructions below. Then follow charging procedures outlined.

READ ALL INSTRUCTIONS

- **Do not charge or use battery in explosive atmospheres, such as in the presence of flammable liquids, gases or dust.** Inserting or removing the battery from the charger may ignite the dust or fumes.
- **Never force battery pack into charger. Do not modify battery pack in any way to fit into a non-compatible charger as battery pack may rupture causing serious personal injury.**
- Charge the battery packs only in DEWALT chargers.
- **DO NOT splash or immerse in water or other liquids.**
- **Do not store or use the tool and battery pack in locations where the temperature may fall below 4 °C (39.2 °F) (such as outside sheds or metal buildings in winter), or reach or exceed 40 °C (104 °F) (such as outside sheds or metal buildings in summer).**
- **Do not incinerate the battery pack even if it is severely damaged or is completely worn out.** The battery pack can explode in a fire. Toxic fumes and materials are created when lithium-ion battery packs are burned.
- **If battery contents come into contact with the skin, immediately wash area with mild soap and water.** If battery liquid gets into the eye, rinse water over the open eye for 15 minutes or until irritation ceases. If medical attention is needed, the battery electrolyte is composed of a mixture of liquid organic carbonates and lithium salts.
- **Contents of opened battery cells may cause respiratory irritation.** Provide fresh air. If symptoms persists, seek medical attention.



WARNING: Burn hazard. Battery liquid may be flammable if exposed to spark or flame.



WARNING: Never attempt to open the battery pack for any reason. If battery pack case is cracked or damaged, do not insert into charger. Do not crush, drop or damage battery pack. Do not use a battery

pack or charger that has received a sharp blow, been dropped, run over or damaged in any way (i.e., pierced with a nail, hit with a hammer, stepped on). Electric shock or electrocution may result. Damaged battery packs should be returned to service centre for recycling.



WARNING: Fire hazard. Do not store or carry the battery pack so that metal objects can contact exposed battery terminals. For example, do not place the battery pack in aprons, pockets, tool boxes, product kit boxes, drawers, etc., with loose nails, screws, keys, etc.



CAUTION: When not in use, place tool on its side on a stable surface where it will not cause a tripping or falling hazard. Some tools with large battery packs will stand upright on the battery pack but may be easily knocked over.

Transportation



WARNING: Fire hazard. Transporting batteries can possibly cause fire if the battery terminals inadvertently come in contact with conductive materials. When transporting batteries, make sure that the battery terminals are protected and well insulated from materials that could contact them and cause a short circuit. **NOTE:** Lithium-ion batteries should not be put in checked baggage.

DEWALT batteries comply with all applicable shipping regulations as prescribed by industry and legal standards which include UN Recommendations on the Transport of Dangerous Goods; International Air Transport Association (IATA) Dangerous Goods Regulations, International Maritime Dangerous Goods (IMDG) Regulations, and the European Agreement Concerning The International Carriage of Dangerous Goods by Road (ADR). Lithium-ion cells and batteries have been tested to section 38.3 of the UN Recommendations on the Transport of Dangerous Goods Manual of Tests and Criteria.

In most instances, shipping a DEWALT battery pack will be excepted from being classified as a fully regulated Class 9 Hazardous Material. In general, only shipments containing a lithium-ion battery with an energy rating greater than 100 Watt Hours (Wh) will require being shipped as fully regulated Class 9. All lithium-ion batteries have the Watt Hour rating marked on the pack. Furthermore, due to regulation complexities, DEWALT does not recommend air shipping lithium-ion battery packs alone regardless of Watt Hour rating. Shipments of tools with batteries (combo kits) can be air shipped as excepted if the Watt Hour rating of the battery pack is no greater than 100 Wh. Regardless of whether a shipment is considered excepted or fully regulated, it is the shipper's responsibility to consult the latest regulations for packaging, labeling/marketing and documentation requirements.

The information provided in this section of the manual is provided in good faith and believed to be accurate at the time the document was created. However, no warranty, expressed or implied, is given. It is the buyer's responsibility to ensure that its activities comply with the applicable regulations.

Storage Recommendations

1. The best storage place is one that is cool and dry away from direct sunlight and excess heat or cold. For optimum battery performance and life, store battery packs at room temperature when not in use.
2. For long storage, it is recommended to store a fully charged battery pack in a cool, dry place out of the charger for optimal results.

NOTE: Battery packs should not be stored completely depleted of charge. The battery pack will need to be recharged before use.

Labels on Charger and Battery Pack

In addition to the pictographs used in this manual, the labels on the charger and the battery pack may show the following pictographs:



Read instruction manual before use.



See **Technical Data** for charging time.



Do not probe with conductive objects.



Do not charge damaged battery packs.



Do not expose to water.



Have defective cords replaced immediately



Charge only between 4 °C and 40 °C.



Only for indoor use.



Discard the battery pack with due care for the environment.



Charge DeWALT battery packs only with designated DeWALT chargers. Charging battery packs other than the designated DeWALT batteries with a DeWALT charger may make them burst or lead to other dangerous situations.



Do not incinerate the battery pack.

Battery Type

The following tools operate on a 54V(60V Max) battery pack: DCMAS5713

Refer to **Technical Data** for more information.

Package Contents

The package contains:

- 1 Powerhead
- 1 Auxiliary handle
- 4 Auxiliary handle bolts
- 4 Auxiliary handle washers
- 1 Handle barrier
- 1 Shoulder strap
- 1 Hex wrench
- 1 Charger (X1 models)
- 1 Li-Ion battery pack (X1 models)
- 1 Instruction manual

NOTE: Battery packs, chargers and kitboxes are not included with N models. Battery packs and chargers are not included with NT models. B models include Bluetooth® battery packs.

- Check for damage to the tool, parts or accessories which may have occurred during transport.
- Take the time to thoroughly read and understand this manual prior to operation.

Markings on Tool

The following pictograms are shown on the tool:



Read instruction manual before use.



Wear eye protection.



Wear ear protection.



No hands



Wear slip-resistant footwear.



Wear slip-resistant gloves.



Wear head protection.



Do not expose the tool to rain or high humidity or leave outdoors while it is raining.



Switch the tool off. Before performing any maintenance on the tool, remove the battery from the tool.



Keep bystanders away.



Date Code Position (Fig. B)

The production date code **13** consists of a 4-digit year followed by a 2-digit week and is extended by a 2-digit factory code.

Description (Fig. A, E)



WARNING: Never modify the area light. Damage or personal injury could result.

- 1 Variable speed trigger
- 2 Lock-off lever
- 3 Lock-off tab
- 4 Powerhead handle
- 5 Speed control switch
- 6 Auxiliary handle
- 7 Strap mount
- 8 Shoulder strap (Fig. F)

Intended Use

This powerhead has been designed for powering DEWALT attachment capable heads. DO NOT use this tool for any job other than its intended use.

DO NOT use under wet conditions or in the presence of flammable liquids or gases.

DO NOT let children come into contact with the tool.

Supervision is required when inexperienced operators use this tool.

- **Young children and the infirm.** This appliance is not intended for use by young children or infirm persons without supervision.
- This product is not intended for use by persons (including children) suffering from diminished physical, sensory or mental abilities; lack of experience, knowledge or skills unless they are supervised by a person responsible for their safety. Children should never be left alone with this product.

ASSEMBLY AND ADJUSTMENTS



WARNING: To reduce the risk of serious personal injury, turn tool off and disconnect battery pack before making any adjustments or removing/installing attachments or accessories. An accidental start-up can cause injury.



WARNING: Use only DEWALT battery packs and chargers.

Inserting and Removing the Battery Pack from the Tool (Fig. B)

NOTE: Make sure your battery pack **14** is fully charged.

To Install the Battery Pack into the Tool Handle

1. Align the battery pack **14** with the rails inside the tool's handle (Fig. B).
2. Slide it into the handle until the battery pack is firmly seated in the tool and ensure that you hear the lock snap into place.

To Remove the Battery Pack from the Tool

1. Press the release button **15** and firmly pull the battery pack out of the tool handle.
2. Insert battery pack into the charger as described in the charger section of this manual.

Fuel Gauge Battery Packs (Fig. B)

Some DEWALT battery packs include a fuel gauge which consists of three green LED lights that indicate the level of charge remaining in the battery pack.

To actuate the fuel gauge **16**, press and hold the fuel gauge button. A combination of the three green LED lights will illuminate designating the level of charge left. When the level of charge in the battery is below the usable limit, the fuel gauge will not illuminate and the battery will need to be recharged.

NOTE: The fuel gauge is only an indication of the charge left on the battery pack. It does not indicate tool functionality and is subject to variation based on product components, temperature and end-user application.

Attaching the Auxiliary Handle (Fig. A, C)

1. Place the auxiliary handle **6** on top of the upper powerhead pole **19**.
2. Place the handle barrier **17** under the auxiliary handle **6** and upper powerhead pole **19** so the upper powerhead pole **19** is sandwiched between two handle pieces.
NOTE: Before assembling further, take care to align the key **34** on the handle barrier **17** with the key slot **35** on the underside of the upper powerhead pole **19**.
3. Hold the auxiliary handle **6** and handle barrier **17** in place while sliding the four handle bolts **18** with washers **36** into the auxiliary handle **6** from the top, pushing them into the base of the handle barrier **17**.
4. Tighten the four handle bolts **18** with the supplied hex wrench, securing the two handle pieces to the upper powerhead pole **19**.
5. Ensure the handle is securely attached before using.

Powerhead (Fig. D)



WARNING: To reduce risk of injury:

- Before any use, be sure everyone using this unit reads and understands all manufacturer's safety instructions and other information contained in manufacturer's manual.
- Never apply power without an attachment being properly mounted to the powerhead.



WARNING: To reduce the risk of serious personal injury, turn unit off and remove the battery pack before making any adjustments or removing/installing attachments or accessories, or prior to cleaning. An accidental start-up can cause injury.

The powerhead can separate from the attachment by turning the knob **20** counterclockwise and gently pulling them apart by their poles **8**, **19**.

This should only be done with the power switch off and the battery pack removed. Inside the upper powerhead pole **19** is a mechanical coupling that will spin if the powerhead is turned on. This coupling can cause severe injury if contacted while the powerhead is operating.

NOTE: A double shoulder harness is required if the mass of the tool and battery pack exceed 7.5 kg.

Attaching and Adjusting the Shoulder Strap (Fig. E)



WARNING: The shoulder strap should only be slung over one shoulder and not across the body.



WARNING: Use of a shoulder strap **8** is required while using this tool.

Attach the strap to the tool as shown in Fig. E and adjust for proper balance and support.

1. Attach the strap mount.
2. Snap the shoulder strap latch **23** onto the strap mount **7** located on the unit, just in front of the ON/OFF trigger as shown in Fig. E. Adjust the strap so it fits over your shoulder and provides proper balance and support.

OPERATION

Instructions for Use



WARNING: Always observe the safety instructions and applicable regulations.



WARNING: To reduce the risk of serious personal injury, turn tool off and disconnect battery pack before making any adjustments or removing/installing attachments or accessories. An accidental start-up can cause injury.

Proper Hand Position (Fig. A, E)



WARNING: To reduce the risk of serious personal injury, ALWAYS use proper hand position as shown.



WARNING: To reduce the risk of serious personal injury, ALWAYS hold securely in anticipation of a sudden reaction.



WARNING: Hold the tool using only the designated gripping surfaces: The powerhead handle and the auxiliary handle.



WARNING: Do not use the pole as a gripping surface.

Proper hand position requires one hand on the powerhead handle **4** and one hand on the auxiliary handle **6**.

Switching On and Off (Fig. A, G)

To turn the appliance on, push the lock-off tab **3** forward, squeeze the lock-off lever **2** and then the variable speed trigger switch **1**. To turn the appliance off, release the variable speed trigger switch and lock-off lever.



WARNING: Never attempt to lock the trigger in the on position.

Speed Control Switch (Fig. A, G)

This attachment gives you the choice to operate at a more efficient speed to extend the runtime for larger jobs, or accelerate the tool speed for high- performance cutting.

To extend runtime, pull the speed control switch **5** back toward the battery housing into the "LO" position. This mode is best for larger projects that require more time to complete.

To accelerate the attachment, push the speed control switch forward toward the auxiliary handle into the "HI" position. This

mode is best to cut through heavier growth and for applications that need higher RPM.

NOTE: When in "HI" mode, runtime will be decreased as compared to when attachment is in "LO" mode.

MAINTENANCE

Your power tool has been designed to operate over a long period of time with a minimum of maintenance. Continuous satisfactory operation depends upon proper tool care and regular cleaning.



WARNING: To reduce the risk of serious personal injury, turn tool off and disconnect battery pack before making any adjustments or removing/installing attachments or accessories. An accidental start-up can cause injury.

The charger and battery pack are not serviceable.



Lubrication

Your power tool requires no additional lubrication.



Cleaning



WARNING: Blow dirt and dust out of the main housing with dry air as often as dirt is seen collecting in and around the air vents. Wear approved eye protection and approved dust mask when performing this procedure.



WARNING: Never use solvents or other harsh chemicals for cleaning the non-metallic parts of the tool. These chemicals may weaken the materials used in these parts. Use a cloth dampened only with water and mild soap. Never let any liquid get inside the tool; never immerse any part of the tool into a liquid.

Optional Accessories



WARNING: Since accessories, other than those offered by DEWALT, have not been tested with this product, use of such accessories with this tool could be hazardous. To reduce the risk of injury, only DEWALT recommended accessories should be used with this product.

Consult your dealer for further information on the appropriate accessories.

Protecting the Environment



Separate collection. Products and batteries marked with this symbol must not be disposed of with normal household waste.

Products and batteries contain materials that can be recovered or recycled reducing the demand for raw materials. Please recycle electrical products and batteries according to local provisions. Further information is available at www.2helpU.com.

Rechargeable Battery Pack

This long life battery pack must be recharged when it fails to produce sufficient power on jobs which were easily done before. At the end of its technical life, discard it with due care for our environment:

- Run the battery pack down completely, then remove it from the tool.
- Li-Ion cells are recyclable. Take them to your dealer or a local recycling station. The collected battery packs will be recycled or disposed of properly.

After Service and Repair

DEWALT service centers are staffed with trained personnel to provide customers with efficient and reliable product service. We do not take any responsibility when you have repaired in unauthorized service center. You can refer to the leaflet of CONTACT CENTER LOCATOR in product package and contact us through hotline, website or social media to find the nearest DEWALT service center around you.

锂电无刷园林工具多功能动力头

DCMAS5713

恭喜!

感谢您选购DEWALT工具。凭借多年的产品开发和创新能力，DEWALT 已经成为专业电动工具用户最可靠的合作伙伴之一。

技术数据

		DCMAS5713
电压	V _{DC}	54V(60V MAX)
重量(不含电池包)	kg	3.4



警告: 为降低伤害风险, 请阅读使用手册。

定义: 安全指南

下列定义描述了各标志术语的严重程度。请仔细阅读本手册, 并注意这些标志。



危险: 表示存在紧急的危险情况, 如果不加以避免, 将导致死亡或重伤。



警告: 表示存在潜在危险情况, 如果不加以避免, 可能导致死亡或重伤。



小心: 表示存在潜在危险情况, 如果不加以避免, 可能导致轻度或中度伤害。

注意: 表示存在不涉及人身伤害的情况, 如果不加以避免, 可能导致财产损失。



表示存在触电风险。



表示存在火灾风险。

电池				充电器 / 充电时间 (分钟)**		
型号	V _{DC}	电池容量 (Ah)	重量 (kg)	DCB112	DCB115	
				DCB1102	DCB1104	DCB118
DCB606	18/54 (最大 20/60)	6.0/2.0	1.05	170	90	60
DCB609/DCB609G	18/54 (最大 20/60)	9.0/3.0	1.46	270	135*	75*
DCB612	18/54 (最大 20/60)	12.0/4.0	1.44	350	180	120
DCB615	18/54 (最大 20/60)	15.0/5.0	2.12	450	230	125
DCB182	18 (最大 20)	4.0	0.61	120	60	60/40**
DCB203	18 (最大 20)	2.0	0.40	60	30	30
DCB184/DCB184G	18 (最大 20)	5.0	0.62	150	75	75/50**
DCB208	18 (最大 20)	8.0	0.95	240	120	70
DCBP034	18 (最大 20)	1.7	0.32	50	27	27
DCBP520	18 (最大 20)	5.0	0.75	150	75	75/50**

*日期码 201811475B 或以后

**日期码 201536 或以后

***电池包充电时间表仅供参考; 实际充电时间将根据电池包的温度和状况而变化。

电动工具通用安全警告



警告: 请阅读本电动工具随附的所有安全警告、说明、图示和规定。未能遵照以下所列说明会导致电击、火灾和/或严重伤害。

保存所有警告和说明书以备查阅。

警告中的术语“电动工具”指市电驱动(有线)电动工具或电池驱动(无线)电动工具。

1) 工作场地的安全

- 保持工作场地清洁、明亮。杂乱和黑暗的场地会引发事故。
- 不要在易爆环境, 如有易燃液体、气体或粉尘的环境下操作电动工具。电动工具产生的火花会点燃粉尘或气体。
- 操作电动工具时, 远离儿童和旁观者。注意力不集中会让你失去对工具的控制。

2) 电气安全

- 电动工具插头必须与插座相配。绝不能以任何方式改装插头。需接地的电动工具不能使用任何转换插头。
未经改装的插头和相配的插座将降低电击风险。
- 避免人体接触接地表面, 如管道、散热片、靶场和冰箱。如果你身体接触接地表面会增加电击风险。
- 不得将电动工具暴露在雨中或潮湿环境中。水进入电动工具将增加电击风险。
- 不得滥用电源线。绝不能用电源线搬运、拉动电动工具或拔出其插头。使电源线远离热源、油、锐边或运动部件。受损或缠绕的电源线会增加电击风险。
- 当在户外使用电动工具时, 使用适合户外使用的延长线。适合户外使用的电线将降低电击风险。
- 如果无法避免在潮湿环境中操作电动工具, 应使用带有剩余电流装置(RCD)保护的电源。RCD的使用可降低电击风险。

3) 人身安全

- 保持警觉, 当操作电动工具时关注所从事的操作并保持清醒。当你感到疲倦, 或在有药物、酒精或治疗反应时, 不要操作电动工具。在操作电动工具时瞬间的疏忽会导致严重人身伤害。
- 使用个人防护装置。始终佩戴护目镜。诸如适当条件下使用防尘面具、防滑安全鞋、安全帽、听力防护等装置能减少人身伤害。
- 防止意外启动。在连接电源和/或电池组、拿起或搬运工具前, 应确保开关处于关断位置。手指放在开关上搬运工具或开关处于接通时通电会导致危险。
- 在电动工具接通之前, 拿掉所有调节钥匙或扳手。遗留在电动工具旋转零件上的扳手或钥匙会导致人身伤害。
- 手不要过分伸展。时刻注意立足点和身体平衡。这样能在意外情况下能更好地控制住电动工具。
- 着装适当。不要穿宽松衣服或佩戴饰品。让你的头发和衣服远离运动部件。宽松衣服、配饰或长发可能会卷入运动部件。

- 如果提供了与排屑、集尘设备连接用的装置, 要确保其连接完好且使用得当。使用集尘装置可降低尘屑引起的危险。
- 不要因为频繁使用工具而产生的熟悉感而掉以轻心, 忽视工具的安全准则。某个粗心的动作可能瞬间导致严重的伤害。

4) 电动工具使用和注意事项

- 不要勉强使用电动工具, 根据用途使用合适的电动工具。选用合适的按照额定值设计的电动工具会使你工作更有效、更安全。
- 如果开关不能接通或关断电源, 则不能使用该电动工具。不能通过开关来控制的电动工具是危险的且必须进行修理。
- 在进行任何调节、更换附件或贮存电动工具之前, 必须从电源上拔掉插头和/或卸下电池组(如可拆卸)。这种防护性的安全措施降低了电动工具意外起动的风险。
- 将闲置不用的电动工具贮存在儿童所及范围之外, 并且不允许不熟悉电动工具和不了解这些说明的人操作电动工具。电动工具在未经培训的使用者手中是危险的。
- 维护电动工具及其附件。检查运动部件是否调整到位或卡住, 检查零件破损情况和影响电动工具运行的其他状况。如有损坏, 应在使用前修理好电动工具。许多事故是由维护不良的电动工具引发的。
- 确保切削刀具锋利、干净。维护良好地有锋利切削刃的刀具不易卡住而且容易控制。
- 按照使用说明书, 并考虑作业条件和要进行的作业来选择电动工具、附件和工具的刀头等。将电动工具用于那些与其用途不符的操作可能会导致危险情况。
- 保持手柄和握持表面干燥、清洁, 不得沾有油脂。在意外的情况下, 湿滑的手柄不能保证握持的安全和对工具的控制。

5) 电池式工具使用和注意事项

- 仅使用生产者规定的充电器充电。将适用于某种电池组的充电器用到其他电池组时可能会发生着火危险。
- 仅使用配有专用电池组的电动工具。使用其他电池组可能会产生伤害和着火危险。
- 当电池组不用时, 将它远离其他金属物体, 例如回形针、硬币、钥匙、钉子、螺钉或其他小金属物体, 以防电池组一端与另一端连接。电池组端部短路会引起燃烧或着火。
- 在滥用条件下, 液体可能会从电池组中溅出, 应避免接触。如果意外碰到液体, 用水冲洗。如果液体碰到了眼睛, 还应寻求医疗帮助。从电池中溅出的液体可能会发生腐蚀或燃烧。
- 不要使用损坏或改装过的电池组或工具。损坏或改装过的电池组可能呈现无法预测的结果, 导致着火、爆炸或伤害。
- 不要将电池组或工具暴露于火焰或高温中。电池组暴露于火或高于130°C的高温中可能会发生爆炸。

- g) 请遵循所有充电说明, 请勿在说明中规定的温度范围以外的环境对电池组或工具充电。不当或在指定范围以外的温度下充电, 可能导致电池损坏并增加火灾风险。

6) 维修

- a) 让专业维修人员使用相同的备件维修电动工具。这将保证所维修的电动工具的安全。
- b) 切勿维修损坏的电池组。电池组只能由生产商或其授权的维修服务商进行维修。

他人的安全

- a) 本设备不适用于身体、感官或精神能力较弱或缺乏经验和知识的人员(包括儿童)使用, 除非有负责其安全的人员进行监督或提供指导。
- b) 必须看好儿童, 确保其不会将此设备当做玩具玩耍。
- c) 在车辆中存放或运输设备时, 应将其放置在后备箱中或进行固定, 以防设备在车辆的速度或方向突然改变时发生移动。
- d) 设备不用时应存放在干燥、通风且儿童无法触及的位置。
- e) 儿童不得接触存放的设备。

充电器

DeWALT充电器无需做出任何调整, 专为简易操作而设计。

电气安全

电机只适用一种工作电压。请务必检查电池组的电压是否是和铭牌上的电压一致。请务必检查电池组的电压是否是和铭牌上的电压一致。



DeWALT充电器符合IEC60335双重绝缘要求, 因此无需使用接地线。

如果电源线损坏, 必须仅由DeWALT或授权的维修机构负责更换。

使用延长线

除非绝对必要, 否则请勿使用延长线。使用适合您的充电器输入功率的合格延长线(请参阅**技术数据**)。最小的导线尺寸为1 mm²; 最大长度为30m。

使用电缆卷筒时, 请务必拉出所有的电缆。

针对所有电池充电器的重要安全说明

请妥善保管本说明: 本手册包含重要的兼容电池充电器安全和操作说明(请参阅**技术数据**)。

- 在使用充电器之前, 请先阅读所有说明以及充电器、电池组和使用电池组的产品上的警告标记。



警告: 电击危险。请勿让任何液体进入充电器, 否则可能会导致触电。



警告: 我们建议使用漏电保护额定电流为30毫安或以下的漏电保护装置。



小心: 烧伤危险。为降低人身伤害风险, 请仅使用DeWALT充电式电池充电。使用其它类型的电池可能会引起爆裂, 并导致人身伤害和损害。



小心: 应看管好儿童, 以确保他们不将此设备当做玩具来玩。

注意: 在某些情况下, 当充电器的插头插入电源插座时, 充电器内部裸露的充电触点可能因为外来物件而短路。请勿让能导电的异物靠近充电器腔, 这些外来物件包括但不限于钢棉、铝箔或任何金属颗粒的堆积物。充电器内没有电池组时, 请断开充电器与电源的连接。清洗前, 务必拔掉充电器。

- 请勿试图使用本手册指定的充电器以外的任何其它充电器为电池组充电。充电器和电池组都是专门设计的, 互相配合使用。
- 除了为DeWALT充电式电池充电以外, 这些充电器并非设计用于其他用途。否则, 可能会导致火灾、触电或电击。
- 请勿将充电器暴露于雨中或雪中。
- 断开充电器连接时, 应捏住插头将其拔出, 而非通过拉拽电源线拔下插头。这将降低对电插头和电线的损害风险。
- 确保电源线布置在不易踩踏、踢绊、拉扯或会受到损害或压力的位置。
- 除非绝对必要, 否则请勿使用延长线。使用不正确的延长线可能导致火灾、触电或电击的风险。
- 请勿将任何物件放在充电器上面, 或是把充电器放在可能会堵住通风槽的柔软表面, 导致充电器的内部过热。

请把充电器放置在远离任何热源的地方。充电器通过外壳顶端和底端的槽进行通风。

- 请勿使用电源线或插头已损坏的充电器, 请立即更换这些充电器。
- 如果充电器受到强烈重击、掉落或出现其他损坏情况, 请勿使用充电器。请将损坏的充电器送到授权服务中心。
- 请勿自行拆卸充电器。请将需要检修或修理的充电器送到授权服务中心。重装不正确可能导致触电、电击或火灾风险。
- 必须立即将已损坏的电源线交由制造商、服务代理或类似的合格人员进行更换以防止安全隐患。
- 清洁前, 请先断开充电器和插座的连接, 以降低触电风险。取出电池组不会降低此风险。
- 不得将两个充电器连接在一起。
- 充电器是为220V-240V的标准家用电源而设计。请勿试图在任何其他电压下使用充电器。此规则不适用于车载充电器。

为电池充电(图B)













1. 插入电池组前, 先将充电器的插头插到相应的电源插座上。
2. 将电池组**14**插入充电器, 确保电池组在充电器中完全就位。红色(充电中)指示灯将不断闪烁, 表示充电过程已经开始。
3. 灯持续常亮表示充电完成。电池组已完全充电, 此时可使用或留在充电器中。从充电器上取下电池组时, 请按下电池组上的电池释放按钮**15**。

注意: 为了确保锂离子电池组的效能和使用寿命最大化, 在首次使用电池组之前必须将其完全充电。

充电器操作

关于电池组的充电状态，请参阅以下指示灯说明。

指示灯

	第1阶段充电		
	第2阶段充电		
	已完全充电		
	热/冷电池组 延迟*		

* 红色指示灯会继续闪烁，但黄色指示灯在本次操作过程中会亮起。电池组达到适当温度后，黄色指示灯会熄灭，充电器将恢复充电程序。

兼容充电器不会对故障电池组充电充电器指示灯不亮时表示电池有故障。

注意：这可能也表示充电器有问题。

如果充电器提示存在故障，请将充电器和电池组送到授权的服务中心进行测试。

热/冷电池组延迟

当充电器检测到电池组过热或过冷时，它会启动热/冷电池组延迟模式，暂停充电，直到电池组达到适当的温度。然后，充电器会自动切换到电池组充电模式。此功能可确保电池组拥有最长的使用寿命。

冷电池组充电速度比热电池组充电速度慢。电池组在整个充电周期的充电速度都会较慢，即使电池组升温也不会恢复到最大速度。

电子保护系统

XR锂离子电池工具采用了电子保护系统设计，可防止电池组过载、过热或过度放电。

如果电子保护系统处于运作状态，该工具将自动停止操作。如果发生这种情况，请将锂离子电池组放在充电器上，直至其完全充满电。

壁挂式安装

这些充电器设计为可以安装在墙上，也可以直立在桌面或工作台上。如果安装在墙上，请确保充电器的位置可以连接到电源插座，并且远离墙角或其他可能妨碍空气流通的障碍物。将充电器背面作为在墙上安装螺丝的位置模板。使用至少25.4毫米长、螺丝帽直径至少7.9毫米的石膏板螺丝（单独购买）牢固固定充电器，将螺丝最大限度钉入木材，预留约5.5毫米露在墙外。将充电器背面的安装槽对准露出的螺丝，完全放置到位。

充电器清洁说明

 **警告：电击危险。**清洁前，请将充电器从交流电源插座上拔下。可用布或非金属软刷清除充电器外部的污垢和油脂。请勿使用水或任何清洁剂。不得让任何液体渗入工具，不得让工具的任何部件浸在液体中。

电池组

针对所有电池组的重要安全说明

在订购更换电池组时，请务必附上目录型号和电压。

包装箱内的电池组并未完全充电。使用电池组和充电器之前，请阅读下列安全说明，然后遵循所述的充电程序。

请阅读所有说明

- 请勿在易爆环境，如有易燃液体、气体或粉尘的环境中充电或使用电池。在充电器中插入或取出电池时可能会点燃粉尘或气体。
- 不得强行将电池放进充电器。请勿以任何方式改装电池组并将电池组插入不兼容的充电器，这种操作可能会导致电池组破裂，造成严重的人身伤害。
- 只使用DeWALT充电器为电池组充电。
- 请勿给电池组喷洒水或其他液体或将其浸泡在水或其他液体中。
- 请勿在温度可能降至4°C(39.2°F)的地方(如冬天户外的棚子或金属建筑物中)或达到或超过40°C(104°F)的地方(如夏天户外的棚子或金属建筑物中)存储或使用工具和电池组。
- 即使电池组严重受损或完全损坏，也请勿焚化电池组。电池组在火中会发生爆炸。锂离子电池组在燃烧时会释放有毒气体和物质。
- 如果电池液体接触到皮肤，请立即以中性肥皂和清水冲洗接触的地方。如果电池液体不慎进入眼睛，应睁开眼睛并用清水冲洗至少15分钟或直到刺激感消失。如果需要医疗救助，请告知医护人员。电池电解质由液状有机碳酸盐和锂盐的混合物组成。
- 已打开电池的內部物质可能导致呼吸道刺激。请保持空气流通。如果症状持续存在，请就医。



警告：烧伤危险。电池液如果接触到火花或火焰可能会燃烧。



警告：不得以任何理由试图打开电池组。电池组外壳破裂或损坏时，请勿将电池组插入充电器。请勿挤压、掉落或损坏电池组。请勿使用受过强烈重击、掉落、碾压或以任何其它方式(如被钉子穿破、受到锤子的重击、踩踏)受损的电池组或充电器。否则可能会引起触电或电击。损坏的电池组应送回服务中心进行回收。



警告：火灾危险。请勿在存储或搬运电池组时让金属物品接触暴露的电池两极。例如，请勿将电池组放在围裙、口袋、工具箱、产品套件盒、抽屉等可能与散钉、螺丝、钥匙等物品接触的地方。



小心：不使用时，应将工具侧放在稳定的表面上，以免造成绊倒或坠落的危险。一些带有大型电池组的工具可以直立在电池组上，但可能很容易被撞倒。

运输



警告：火灾危险。电池运输途中，如果电池两极意外接触导电材料，可能会引发火灾。运输电池时，务必保护电池两极，确保与可能接触电池导致短路的材料良好绝缘。**注意：**不应将锂离子电池放入托运行李中。

DeWALT电池符合所有适用的行业和法律标准规定的运输规范，包括《联合国危险品运输建议规章范本》(UN Recommendations on the Transport of Dangerous Goods)、《国际航空运输协会(IATA)危险品规则》(International Air Transport Association (IATA) Dangerous Goods Regulations)、

《国际海运危险品 (IMDG) 规则》(International Maritime Dangerous Goods (IMDG) Regulations) 和《欧洲危险货物国际公路运输协定》(European Agreement Concerning The International Carriage of Dangerous Goods by Road) (ADR)。离子电池和电池组已遵循《联合国危险品运输建议规章范本手册》第38.3节关于测试和标准的说明通过测试。

大多数情况下，发运DeWALT电池组不属于完全管制的9类危险品。一般情况下，只有当运输包含一个能量等级大于100瓦时(Wh)的锂离子电池时，才需要作为完全管制的9类危险品发运。所有锂离子电池外壳上均标注有瓦时等级。此外，由于法规比较复杂，无论瓦时等级是多少，DeWALT都不建议单独空运锂离子电池组。发运包含电池的工作(组合套件)时，如果电池组的能量等级不大于100瓦时(Wh)，则可以按计划空运。

无论发运是否纳入完全管制范围内，运输公司均有责任遵循最新法规中关于包装、标签/标记和单据的要求。

本手册本节的信息是出于善意提供，且认为在编制文档时准确无误。不提供明示或暗示的担保。购买方负有确保其行为遵守适用法规的责任。

存放建议

1. 最好将电池存放在阴凉、干燥、远离阳光直射、不会过热或过冷的地方。为了获得最佳的电池性能和使用寿命，请您在不使用电池组时将其存储在室温下。
2. 长期存储时，建议将已完全充电的电池组从充电器取出，存储在阴凉、干燥的地方，以达到最佳效果。

注意：电池组不应在电池已完全耗尽的状态下存放。使用电池组之前，必须重新为电池组充电。

充电器和电池组上的标签

除了在本手册中所使用的标志，充电器和电池组的标签还包括：



使用前请阅读使用手册。



如需了解充电时间详细信息，请参阅**技术数据**。



请勿使用导电物体戳刺。



请勿对损坏的电池组充电。



请勿将其暴露于水中。



应立即更换有缺陷的电线。



请只在4°C和40°C之间的温度下充电。



只能在室内使用。



弃置电池组时，请妥善处理以保护我们的环境。



请勿焚化电池组。

电池类型

以下工具使用54V (60V Max) 的电池组:DCMAS5713
更多信息，请参考**技术数据**。

包装内的物品

包装中包含：

- 1 多功能动力头
- 1 辅助手柄
- 4 辅助手柄螺栓
- 4 辅助手柄螺丝垫圈
- 1 带防护手柄压板
- 1 肩带
- 1 六角扳手
- 1 充电器 (X1型号)
- 1 锂离子电池组 (X1型号)
- 1 使用手册

注意：电池组、充电器和工具箱没有随N型号附送。电池组和充电器没有随NT型号附送。B型号包括蓝牙®电池组。

- 检查工具、部件或附件是否在运输过程中损坏。
- 操作前，请抽空仔细阅读并掌握本手册。

工具上的标记

工具上印有如下图形：



使用前请阅读使用手册。



请佩戴护目装备。



请佩戴听力保护器。



请勿用手触摸



请穿戴防滑鞋袜。



请佩戴手套。



请佩戴头部保护装备。



请勿将工具暴露在雨中或高湿度环境中，也不要在下雨时将工具放在室外。



关闭工具。在对工具进行任何维护之前，请将电池从工具中取出。



使旁观者远离工具。

日期代码位置(图B)

生产日期代码 **13** 由4位数的年和2位数的周组成，后跟2位数的工厂代码。

描述(图A, E)

警告：请勿改装区域光源。否则可能会导致损坏或人身伤害。

- 1 无级变速开关
- 2 安全开关
- 3 安全开关止动片
- 4 动力头主手柄
- 5 速度控制开关
- 6 辅助手柄
- 7 绑带底座
- 8 肩带(图F)

设计用途

该产品专为DeWALT附件主机头供电而设计。请勿将此工具用于预期用途以外的任何工作。

请勿在潮湿环境中，或在存在易燃液体或气体的环境中使用本工具。

请勿让儿童接触本工具。缺乏经验的操作员需要在监督下使用本工具。

- **儿童和体弱者。**在没有他人监督的情况下，儿童或体弱者不适宜使用本产品。
- 本产品不适合体力、感官或智力不足以及缺乏经验、知识或技能的人员(包括儿童)使用，除非一旁有能为他们的安全负责的监督人员。不得在无人监管的情况下让儿童接触本产品。

组装与调整

警告：为降低严重的人身伤害风险，在进行任何调整或取出/安装附件或配件之前，请关闭工具并断开电池组连接。意外启动工具可能会造成伤害。

警告：仅使用DeWALT电池组和充电器。

插入或取出工具上的电池包(图B)

注意：确保您的电池包 **14** 已经充满电。

要将电池组安装到工具手柄中

1. 将电池组 **14** 对准工具手柄内的轨道(图B)。
2. 将电池组滑入手柄内，使其牢牢地固定在工具内，并确保您听到其锁定到位的声音。

从工具中取出电池组

1. 按下释放按钮 **15**，将电池组从工具握柄中稳稳地拉出。

2. 按本手册充电器部分所述将电池组插入充电器中。

电量计电池组(图B)

部分DeWALT电池组带有一个包含三个绿色LED指示灯的电量计，用于指示电池组内的剩余电量。

按住电量计按钮不松开，即可启动电量计 **16**。三个绿色LED指示灯将以组合方式亮起，以指示剩余电量。当电池内的电量低于可用限制时，电量计将不会亮起，电池将需要重新充电。

注意：电量计仅指示电池组的剩余电量。它并不表示该工具的功能，且将根据产品组件、温度和最终使用者的使用情况而有所不同。

固定辅助手柄(图A, C)

1. 将辅助手柄 **6** 放在上机头杆 **19** 的顶部。
2. 将带防护手柄压板 **17** 放在辅助手柄 **6** 和上机头杆 **19** 的下方，这样上机头杆 **19** 会夹在两个手柄之间。
注意：在进一步组装之前，请注意将带防护手柄压板 **17** 上的凸起 **34** 对准上机头杆 **19** 底部的孔 **35**。
3. 将辅助手柄 **6** 和带防护手柄压板 **17** 固定到位的同时，将带垫圈 **36** 的四颗手柄螺栓 **18** 从顶部滑入辅助手柄 **6**，将其推入带防护手柄压板 **17** 的底座。
4. 用随附的六角扳手固定四颗手柄螺栓 **18**，使两个手柄固定在上机头杆 **19** 上。
5. 使用前确保手柄安装牢固。

机头(图D)

警告：为降低人身伤害风险：

- 在使用前，请确保使用本设备的每个人已阅读和理解制造商提供的所有安全说明以及制造商手册中包含的其他信息。
- 如果设备的机头未正确安装附件，请勿通电。

警告：为降低严重人身伤害的风险，在进行任何调节或拆除/安装配件或附件之前，或进行清洁之前，请先关闭本设备并拆下电池组。意外启动工具可能会造成伤害。

逆时针转动旋钮 **20**，轻轻将两端金属杆拔开，主动力头就可以与其他附件头分离。

上述操作必须在电源关闭，电池组拆除的情况下进行。机器在运作过程中，主动力头金属杆内部含有一个金属联接件，其会在内部旋转。如果在产品工作时候接触到该金属联接件，可能会造成严重的人身伤害。

注意：如果工具和电池组的重量超过7.5kg，则需要使用双肩背带。

固定并调整肩带(图E)

警告：肩带只能挂在一侧肩膀上，而不应横跨整个身体。

警告：使用本工具时需使用肩带 **8**。

如图E所示，将肩带固定到工具上，然后进行调整，以获得适当的平衡和支撑。

1. 固定肩带底座。
2. 如图E所示，将肩带搭扣 **23** 扣到本设备肩带底座 **7** 上，即开/关扳机之前。调整肩带，使其适合您的肩膀，并提供适当的平衡和支撑。

操作

使用说明

警告：务必遵守安全指示和适用法规。

警告：为降低严重的人身伤害风险，在进行任何调整或取出/安装附件或配件之前，请关闭工具并断开电池组连接。意外启动工具可能会造成伤害。

正确的双手放置位置 (图A, E)

警告：为了减低严重人身伤害的风险，请务必如图示那样正确放置双手。

警告：为了减低造成严重人身伤害的风险，预期有突然反作用力时**务必**握紧。

警告：仅使用指定的抓握面握住工具：机头手柄和辅助手柄。

警告：请勿将杆当作抓握面使用。

正确的双手放置位置要求一只手放在机头手柄④上，另一只手放在辅助手柄⑥上。

开启和关闭 (图A, G)

如要启动设备，将锁片③向前推，挤压锁闭杆②，然后再按下无级变速开关①。如要关闭设备，松开变速扳机开关和锁闭杆即可。

警告：请勿试图将扳机锁定在开启位置。

速度控制开关 (图A, G)

本附件可让您选择以更有效的速度运行，以延长较大规模作业的运行时间，或者加快工具运行的速度，以实现高性能切割。

如要延长运行时间，将速度控制开关⑤向后拉回至电池外壳的“LO”位置。该模式最适合需要更长时间才能完成的较大作业项目。

如要加快附件的速度，将速度控制开关向前推至辅助手柄的“HI”位置。该模式最适合切割较茂密的生长物和需要较高转速的应用。

注意：当处于“HI”模式时，与附件在“LO”模式相比，运行时间会缩短。

维护

您的电动工具设计精良，可以长期使用，仅需极少维护。若要持续令人满意的工作效果，则需对工具进行适当的保养和定期清洁。

警告：为降低严重的人身伤害风险，在进行任何调整或取出/安装附件或配件之前，请关闭工具并断开电池组连接。意外启动工具可能会造成伤害。

充电器和电池组无法维修。



润滑

本电动工具无需另行润滑

NA454848



清洁

警告：一旦看到通风口及其周围积聚了尘屑，请用干燥的空气将灰尘和尘屑从主机外壳内吹出。执行此过程时，需戴上经认可的护目装备和防尘面具。

警告：不得使用溶剂或其他刺激性化学制品来清洁工具的非金属部件。这些化学物质可能会削弱这些部位使用的材料。请用布蘸温和的肥皂水擦拭。不得让任何液体渗入工具，不得让工具的任何部件浸在液体中。

可选配件

警告：由于除DeWALT提供的配件外，其他配件没有经过本产品的测试，因此将这些配件与本工具一起使用可能会有危险。为降低人身伤害风险，本产品只可使用DeWALT推荐的配件。

请向您的经销商咨询更多关于合适附件的信息。

保护环境



分类回收。由此符号标记的产品和电池不得与普通家庭垃圾一起处理。

产品和电池组含可恢复或回收的材料，从而降低对原材料的需求。请根据当地规定回收电子产品和电池。如要获得更多信息，请参看www.2helpU.com。

充电式电池组

本电池组使用寿命长，不能提供顺利完成工作所需的电力时，必须进行充电。电池技术寿命结束时，请妥善处理以保护环境：

- 耗尽电池组的电力，然后将其从工具上拆下。
- 锂离子电池是可回收的。请将它们送往您的经销商处或当地的回收站。回收的电池组将被妥善循环使用或处理。

售后服务和维修

DeWALT维修中心拥有经过培训的人员，能够为顾客提供高效、可靠的产品服务。如果您通过未获授权的维修中心进行维修，我们不会承担任何责任。您可以参见产品包装中的“联系中心定位器”宣传单页，通过热线电话、网站或社交媒体联系我们，找到距离您最近的DeWALT服务中心。

制造商：百得美国公司

地址：701 E Joppa Rd, TW050 MD21286, Towson, 美国

产地：江苏苏州