DEWALT®

XR LI-ION

www.DEWALT.com

DCF889
DCF889H

Figure 1

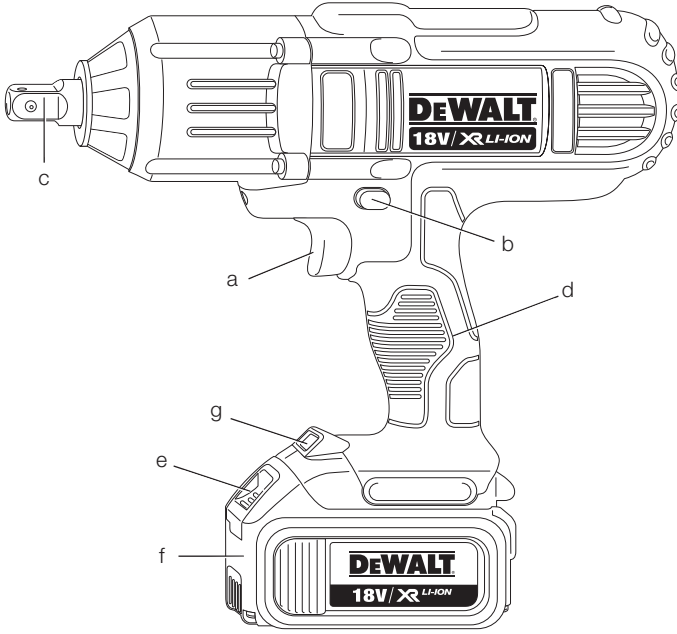
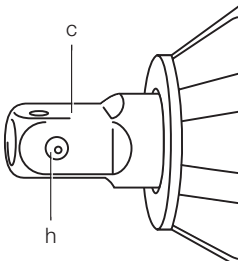
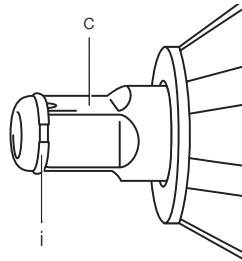

Figure 2



DCF889



DCF889H

Figure 3

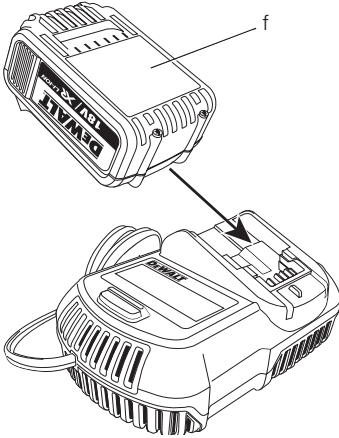

Figure 4

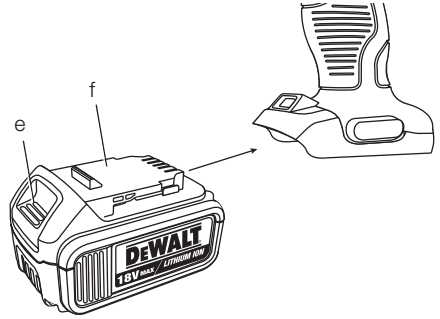

Figure 5

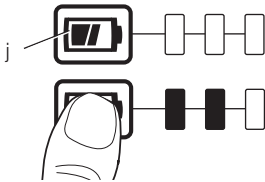
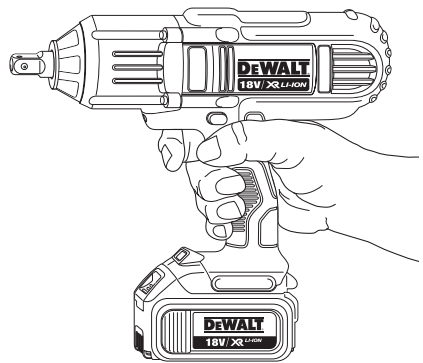

Figure 6



CORDLESS IMPACT WRENCH

DCF889, DCF889H

Congratulations!

You have chosen a DEWALT tool. Years of experience, thorough product development and innovation make DEWALT one of the most reliable partners for professional power tool users.

Technical Data

| DCF889, DCF889H | | |
|-------------------------------|-------------------|--------|
| Voltage | V_{DC} | 18 |
| Battery Type | | Li-Ion |
| No load speed | min^{-1} | 0–1500 |
| Impact rate | min^{-1} | 0–2300 |
| Weight (without battery pack) | kg | 2.5 |

The vibration emission level given in this information sheet has been measured in accordance with a standardised test given in EN 60745 and may be used to compare one tool with another. It may be used for a preliminary assessment of exposure.



WARNING: The declared vibration emission level represents the main applications of the tool. However if the tool is used for different applications, with different accessories or poorly maintained, the vibration emission may differ. This may significantly increase the exposure level over the total working period.

An estimation of the level of exposure to vibration should also take into account the times when the tool is switched off or when it is running but not actually doing the job. This may significantly reduce the exposure level over the total working period.

Identify additional safety measures to protect the operator from the effects of vibration such as: maintain the tool and the accessories, keep the hands warm, organisation of work patterns.

| Battery pack | | DCB180 | DCB181 | DCB182 | DCB184 |
|--------------|----------|--------|--------|--------|--------|
| Battery type | | Li-Ion | Li-Ion | Li-Ion | Li-Ion |
| Voltage | V_{DC} | 18 | 18 | 18 | 18 |
| Capacity | A_h | 3.0 | 1.5 | 4.0 | 5.0 |
| Weight | kg | 0.64 | 0.35 | 0.61 | 0.63 |

| Charger | | DCB105 | | |
|-----------------------|----------|------------------------|------------------------|--|
| Mains voltage | V_{AC} | 220-240 | | |
| Battery type | | Li-Ion | | |
| Approx. charging time | min | 30 | 55 | |
| | | (3.0 Ah battery packs) | (4.0 Ah battery packs) | |
| Weight | kg | 70 | 90 | |
| | | (1.5 Ah battery packs) | (5.0 Ah battery packs) | |
| Weight | kg | 0.49 | | |

Definitions: Safety Guidelines

The definitions below describe the level of severity for each signal word. Please read the manual and pay attention to these symbols.



DANGER: Indicates an imminently hazardous situation which, if not avoided, will result in **death or serious injury**.



WARNING: Indicates a potentially hazardous situation which, if not

avoided, **could** result in **death or serious injury**.



CAUTION: Indicates a potentially hazardous situation which, if not avoided, **may** result in **minor or moderate injury**.

NOTICE: Indicates a practice **not related to personal injury** which, if not avoided, **may** result in **property damage**.



Denotes risk of electric shock.



Denotes risk of fire.



WARNING: To reduce the risk of injury, read the instruction manual.

General Power Tool Safety Warnings



WARNING! Read all safety warnings and all instructions. Failure to follow the warnings and instructions may result in electric shock, fire and/or serious injury.

SAVE ALL WARNINGS AND INSTRUCTIONS FOR FUTURE REFERENCE

The term "power tool" in the warnings refers to your mains-operated (corded) power tool or battery-operated (cordless) power tool.

1) WORK AREA SAFETY

- a) **Keep work area clean and well lit.** Cluttered or dark areas invite accidents.
- b) **Do not operate power tools in explosive atmospheres, such as in the presence of flammable liquids, gases or dust.** Power tools create sparks which may ignite the dust or fumes.
- c) **Keep children and bystanders away while operating a power tool.** Distractions can cause you to lose control.

2) ELECTRICAL SAFETY

- a) **Power tool plugs must match the outlet. Never modify the plug in any way. Do not use any adapter plugs with earthed (grounded) power tools.** Unmodified plugs and matching outlets will reduce risk of electric shock.
- b) **Avoid body contact with earthed or grounded surfaces such as pipes, radiators, ranges and refrigerators.** There is an increased risk of electric shock if your body is earthed or grounded.
- c) **Do not expose power tools to rain or wet conditions.** Water entering a power tool will increase the risk of electric shock.
- d) **Do not abuse the cord. Never use the cord for carrying, pulling or unplugging the power tool. Keep cord away from heat, oil, sharp edges or moving parts.** Damaged or entangled cords increase the risk of electric shock.

- e) **When operating a power tool outdoors, use an extension cord suitable for outdoor use.** Use of a cord suitable for outdoor use reduces the risk of electric shock.
- f) **If operating a power tool in a damp location is unavoidable, use a residual current device (RCD) protected supply.** Use of an RCD reduces the risk of electric shock.

3) PERSONAL SAFETY

- a) **Stay alert, watch what you are doing and use common sense when operating a power tool. Do not use a power tool while you are tired or under the influence of drugs, alcohol or medication.** A moment of inattention while operating power tools may result in serious personal injury.
- b) **Use personal protective equipment. Always wear eye protection.** Protective equipment such as dust mask, non-skid safety shoes, hard hat, or hearing protection used for appropriate conditions will reduce personal injuries.
- c) **Prevent unintentional starting. Ensure the switch is in the off position before connecting to power source and/or battery pack, picking up or carrying the tool.** Carrying power tools with your finger on the switch or energising power tools that have the switch on invites accidents.
- d) **Remove any adjusting key or wrench before turning the power tool on.** A wrench or a key left attached to a rotating part of the power tool may result in personal injury.
- e) **Do not overreach. Keep proper footing and balance at all times.** This enables better control of the power tool in unexpected situations.
- f) **Dress properly. Do not wear loose clothing or jewellery. Keep your hair, clothing and gloves away from moving parts.** Loose clothes, jewellery or long hair can be caught in moving parts.
- g) **If devices are provided for the connection of dust extraction and collection facilities, ensure these are connected and properly used.** Use of dust collection can reduce dust-related hazards.

4) POWER TOOL USE AND CARE

- a) **Do not force the power tool. Use the correct power tool for your application.** The correct power tool will do the job better and safer at the rate for which it was designed.

- b) **Do not use the power tool if the switch does not turn it on and off.** Any power tool that cannot be controlled with the switch is dangerous and must be repaired.
- c) **Disconnect the plug from the power source and/or the battery pack from the power tool before making any adjustments, changing accessories, or storing power tools.** Such preventive safety measures reduce the risk of starting the power tool accidentally.
- d) **Store idle power tools out of the reach of children and do not allow persons unfamiliar with the power tool or these instructions to operate the power tool.** Power tools are dangerous in the hands of untrained users.
- e) **Maintain power tools. Check for misalignment or binding of moving parts, breakage of parts and any other condition that may affect the power tool's operation. If damaged, have the power tool repaired before use.** Many accidents are caused by poorly maintained power tools.
- f) **Keep cutting tools sharp and clean.** Properly maintained cutting tools with sharp cutting edges are less likely to bind and are easier to control.
- g) **Use the power tool, accessories and tool bits etc., in accordance with these instructions taking into account the working conditions and the work to be performed.** Use of the power tool for operations different from those intended could result in a hazardous situation.

5) BATTERY TOOL USE AND CARE

- a) **Recharge only with the charger specified by the manufacturer.** A charger that is suitable for one type of battery pack may create a risk of fire when used with another battery pack.
- b) **Use power tools only with specifically designated battery packs.** Use of any other battery packs may create a risk of injury and fire.
- c) **When battery pack is not in use, keep it away from other metal objects like paper clips, coins, keys, nails, screws or other small metal objects that can make a connection from one terminal to another.** Shorting the battery terminals together may cause burns or a fire.
- d) **Under abusive conditions, liquid may be ejected from the battery, avoid contact. If contact accidentally occurs, flush with**

water. If liquid contacts eyes, additionally seek medical help. Liquid ejected from the battery may cause irritation or burns.

6) SERVICE

- a) **Have your power tool serviced by a qualified repair person using only identical replacement parts.** This will ensure that the safety of the power tool is maintained.

Additional Specific Safety Rules for Impact Wrenches

- **Hold power tool by insulated gripping surfaces when performing an operation where the fastener may contact hidden wiring.** Fasteners contacting a "live" wire may make exposed metal parts of the power tool "live" and could give the operator an electric shock.
- **Use clamps or other practical way to secure and support the workpiece to a stable platform.** Holding the work by hand or against your body is unstable and may lead to loss of control.
- **Wear safety goggles or other eye protection. Hammering and drilling operations cause chips to fly.** Flying particles can cause permanent eye damage.
- **Accessories and tools get hot during operation.** Wear gloves when touching them.
- **Do not operate this tool for long periods of time.** Vibration caused by tool action may be harmful to your hands and arms. Use gloves to provide extra cushion and limit exposure by taking frequent rest periods.

Residual Risks

In spite of the application of the relevant safety regulations and the implementation of safety devices, certain residual risks cannot be avoided. These are:

- Impairment of hearing.
- Risk of personal injury due flying particles.
- Risk of burns due to accessories becoming hot during operation.
- Risk of personal injury due to prolonged use.

Markings on Tool

The following pictograms are shown on the tool:



Read instruction manual before use.

DATE CODE POSITION

The Date Code, which also includes the year of manufacture, is printed into the housing surface that forms the mounting joint between tool and battery.

Example:

2013 XX XX

Year of Manufacture

Important Safety Instructions for All Battery Chargers

SAVE THESE INSTRUCTIONS: *This manual contains important safety and operating instructions for the DCB105 battery charger.*

- Before using the charger, read all instructions and cautionary markings on charger, battery pack and product using the battery pack.



WARNING: Shock hazard. Do not allow any liquid to get inside charger. Electric shock may result.



CAUTION: Burn hazard. To reduce the risk of injury, charge only DEWALT rechargeable battery packs. Other types of batteries may overheat and burst resulting in personal injury and property damage.



CAUTION: Children should be supervised to ensure that they do not play with the appliance.

NOTICE: Under certain conditions, with the charger plugged in to the power supply, the exposed charging contacts inside the charger can be shorted by foreign material. Foreign materials of a conductive nature such as, but not limited to, steel wool, aluminum foil or any buildup of metallic particles should be kept away from charger cavities. Always unplug the charger from the power supply when there is no battery pack in the cavity. Unplug charger before attempting to clean.

- **DO NOT attempt to charge the battery pack with any chargers other than the ones in this manual.** The charger and battery pack are specifically designed to work together.
- **These chargers are not intended for any uses other than charging DEWALT rechargeable batteries.** Any other uses may result in risk of fire, electric shock or electrocution.
- **Do not expose charger to rain or snow.**
- **Pull by plug rather than cord when disconnecting charger.** This will reduce risk of damage to electric plug and cord.
- **Make sure that cord is located so that it will not be stepped on, tripped over or otherwise subjected to damage or stress.**
- **Do not use an extension cord unless it is absolutely necessary.** Use of improper extension cord could result in risk of fire, electric shock or electrocution.
- **When operating a charger outdoors, always provide a dry location and use an extension cord suitable for outdoor use.** Use of a cord suitable for outdoor use reduces the risk of electric shock.
- **Do not block the ventilation slots on the charger. The ventilation slots are located on the top and sides of the charger.** Place the charger in a position away from any heat source.
- **Do not operate charger with damaged cord or plug** — have them replaced immediately.
- **Do not operate charger if it has received a sharp blow, been dropped or otherwise damaged in any way.** Take it to an authorised service centre.
- **Do not disassemble the charger; take it to an authorised service centre when service or repair is required.** Incorrect reassembly may result in a risk of electric shock, electrocution or fire.
- In case of damaged power supply cord the supply cord must be replaced immediately by the manufacturer, its service agent or similar qualified person to prevent any hazard.
- **Disconnect the charger from the outlet before attempting any cleaning. This will reduce the risk of electric shock.** Removing the battery pack will not reduce this risk.
- **NEVER attempt to connect 2 chargers together.**
- **The charger is designed to operate on standard 230 V household electrical power. Do not attempt to use it on any other voltage.** This does not apply to the vehicular charger.

SAVE THESE INSTRUCTIONS**Chargers**

The DCB105 charger accepts 10.8 V, 14.4 V and 18 V Li-Ion (DCB121, DCB123, DCB140, DCB141, DCB142, DCB180, DCB181 and DCB182) battery packs.

This charger requires no adjustment and is designed to be as easy as possible to operate.





Charging Procedure (fig. 3)

1. Plug the charger into an appropriate 230 V outlet before inserting the battery pack.
2. Insert the battery pack (f) into the charger, making sure the pack is fully seated in the charger. The red (charging) light will blink continuously indicating that the charging process has started.
3. The completion of charge will be indicated by the red light remaining ON continuously. The pack is fully charged and may be used at this time or left in the charger.

NOTE: To ensure maximum performance and life of Li-Ion batteries, fully charge the pack before first use.

Charging Process

Refer to the table below for the state of charge of the battery pack.

| State of charge | |
|--|-----------------|
|  charging | — — — — |
|  fully charged | ————— |
|  hot/cold pack delay | — • — • — • — • |
|  problem pack or charger | • • • • • • • • |
|  problem powerline | • • • • • • • • |

This charger will not charge a faulty battery pack. The charger will indicate faulty battery by refusing to light or by displaying problem pack or charger blink pattern.

NOTE: This could also mean a problem with a charger.

If the charger indicates a problem, take the charger and battery pack to be tested at an authorised service centre.

Hot/Cold Pack Delay

When the charger detects a battery that is too hot or too cold, it automatically starts a hot/cold pack

delay, suspending charging until the battery has reached an appropriate temperature. The charger then automatically switches to the pack charging mode. This feature ensures maximum battery life.

XR Li-Ion tools are designed with an Electronic Protection System that will protect the battery against overloading, overheating or deep discharge.

The tool will automatically turn off if the Electronic Protection System engages. If this occurs, place the Li-Ion battery on the charger until it is fully charged.

A cold battery pack will charge at about half the rate of a warm battery pack. The battery pack will charge at that slower rate throughout the entire charging cycle and will not return to maximum charge rate even if the battery warms.

Important Safety Instructions for All Battery Packs

When ordering replacement battery packs, be sure to include the catalog number and voltage.

The battery pack is not fully charged out of the carton. Before using the battery pack and charger, read the safety instructions below and then follow the charging procedures outlined.

READ ALL INSTRUCTIONS

- **Do not charge or use the battery pack in explosive atmospheres, such as in the presence of flammable liquids, gases or dust.** Inserting or removing the battery pack from the charger may ignite the dust or fumes.
- **Never force the battery pack into charger. Do not modify the battery pack in any way to fit into a non-compatible charger as battery pack may rupture causing serious personal injury.**
- Charge the battery packs only in designated DEWALT chargers.
- **DO NOT splash or immerse in water or other liquids.**
- **Do not store or use the tool and battery pack in locations where the temperature may reach or exceed 40 °C (105 °F) (such as outside sheds or metal buildings in summer).**
- For best results, make sure the battery pack is fully charged before use.



WARNING: Never attempt to open the battery pack for any reason. If the battery pack case is cracked or

damaged, do not insert it into the charger. Do not crush, drop or damage battery pack. Do not use a battery pack or charger that has received a sharp blow, been dropped, run over or damaged in any way (e.g., pierced with a nail, hit with a hammer, stepped on). Electric shock or electrocution may result. Damaged battery packs should be returned to the service centre for recycling.



CAUTION: When not in use, place tool on its side on a stable surface where it will not cause a tripping or falling hazard. Some tools with large battery packs will stand upright on the battery pack but may be easily knocked over.

SPECIFIC SAFETY INSTRUCTIONS FOR LITHIUM ION (Li-Ion)

- **Do not incinerate the battery pack even if it is severely damaged or is completely worn out.** The battery pack can explode in a fire. Toxic fumes and materials are created when lithium ion battery packs are burned.
- **If battery contents come into contact with the skin, immediately wash the area with mild soap and water.** If the battery liquid gets into the eye, rinse water over the open eye for 15 minutes or until irritation ceases. If medical attention is needed, the battery electrolyte is composed of a mixture of liquid organic carbonates and lithium salts.
- **Contents of opened battery cells may cause respiratory irritation.** Provide fresh air. If symptoms persists, seek medical attention.



WARNING: Burn hazard. Battery liquid may be flammable if exposed to spark or flame.

Battery Pack

BATTERY TYPE

The DCF889 and DCF889H operate on an 18 volt battery pack.

The DCB180, DCB181 or DCB182 battery packs may be used. Refer to **Technical Data** for more information.

Storage Recommendations

1. The best storage place is one that is cool and dry away from direct sunlight and excess heat or cold. For optimum battery performance and life, store battery packs at room temperature when not in use.
2. For long storage, it is recommended to store a fully charged battery pack in a cool, dry place out of the charger for optimal results.

NOTE: Battery packs should not be stored completely depleted of charge. The battery pack will need to be recharged before use.

Labels on Charger and Battery Pack

In addition to the pictographs used in this manual, the labels on the charger and the battery pack show the following pictographs:



Read instruction manual before use.



Battery charging.



Battery charged.



Hot/cold pack delay.



Problem pack or charger.



Problem powerline.



Do not probe with conductive objects.



Do not charge damaged battery packs.



Use only with DEWALT battery packs. Others may burst causing personal injury and damage.



Do not expose to water.



Have defective cords replaced immediately.



Charge only between 4 °C and 40 °C.



Discard the battery pack with due care for the environment.



Do not incinerate the battery pack.



Li-Ion Charges Li-Ion battery packs.



See **Technical Data** for charging time.



Only for indoor use.

Package Contents

The package contains:

- 1 Impact wrench
- 1 Charger
- 2 Batteries
- 1 Kitbox
- 1 Instruction manual

NOTE: Battery packs, chargers and kitboxes are not included with N-models.

- *Check for damage to the tool, parts or accessories which may have occurred during transport.*
- *Take the time to thoroughly read and understand this manual prior to operation.*

Description (fig. 1, 2)



WARNING: Never modify the power tool or any part of it. Damage or personal injury could result.

- a. Trigger switch
- b. Forward/reverse button
- c. Anvil
- d. Main handle
- e. Battery release button
- f. Battery pack
- g. Worklight
- h. Detent pin (DCF889)
- i. Hog ring (DCF889H)
- j. Fuel gauge (fig. 5)

INTENDED USE

This impact wrench is designed for professional impact fastening applications. The impact function makes this tool particularly useful for driving fasteners in wood, metal and concrete.

DO NOT use under wet conditions or in presence of flammable liquids or gases.

This impact wrench is a professional power tool. **DO NOT** let children come into contact with the tool. Supervision is required when inexperienced operators use this tool.

- This product is not intended for use by persons (including children) suffering from diminished physical, sensory or mental abilities, or for lack of experience and/or for want of knowledge or skills unless they are supervised by a person responsible for their safety. Children should never be left alone to play with this product.

Electrical Safety

The electric motor has been designed for one voltage only. Always check that the battery pack voltage corresponds to the voltage on the rating plate. Also make sure that the voltage of your charger corresponds to that of your mains.



Your DEWALT charger is double insulated in accordance with EN 60335; therefore no earth wire is required.

If the supply cord is damaged, it must be replaced by a specially prepared cord available through the DEWALT service organisation.

Using an Extension Cable

An extension cord should not be used unless absolutely necessary. Use an approved extension cable suitable for the power input of your charger (see **Technical Data**). The minimum conductor size is 1 mm²; the maximum length is 30 m.

When using a cable reel, always unwind the cable completely.

ASSEMBLY AND ADJUSTMENTS



WARNING: Prior to assembly and adjustment, always remove the battery pack. Always switch off the tool before inserting or removing the battery pack.



WARNING: Use only DEWALT battery packs and chargers.

Inserting and Removing the Battery Pack from the Tool (fig. 4)



WARNING: To reduce the risk of serious personal injury, place the forward/reverse button in the lock-off position or turn tool off and disconnect battery pack before making any adjustments or removing/installing attachments or accessories. An accidental start-up can cause injury.

NOTE: Make sure your battery pack (f) is fully charged.

TO INSTALL THE BATTERY PACK INTO THE TOOL HANDLE

1. Align the battery pack (f) with the rails inside the tool's handle (fig. 4).
2. Slide it into the handle until the battery pack is firmly seated in the tool and ensure that it does not disengage.

TO REMOVE THE BATTERY PACK FROM THE TOOL

1. Press the battery release button (e) and firmly pull the battery pack out of the tool handle.
2. Insert battery pack into the charger as described in the charger section of this manual.

FUEL GAUGE BATTERY PACKS (FIG. 5)

Some DEWALT battery packs include a fuel gauge which consists of three green LED lights that indicate the level of charge remaining in the battery pack.

To actuate the fuel gauge, press and hold the fuel gauge button (j). A combination of the three green LED lights will illuminate designating the level of charge left. When the level of charge in the battery is below the usable limit, the fuel gauge will not illuminate and the battery will need to be recharged.

NOTE: The fuel gauge is only an indication of the charge left on the battery pack. It does not indicate tool functionality and is subject to variation based on product components, temperature and end-user application.

OPERATION

Instructions for Use



WARNING: Always observe the safety instructions and applicable regulations.



WARNING: To reduce the risk of serious personal injury, place the forward/reverse button in the lock-off position or turn tool off and disconnect battery pack before making any adjustments or removing/installing attachments or accessories. An accidental start-up can cause injury.

Proper Hand Position (fig. 1, 6)



WARNING: To reduce the risk of serious personal injury, **ALWAYS** use proper hand position as shown.



WARNING: To reduce the risk of serious personal injury, **ALWAYS** hold securely in anticipation of a sudden reaction.

Proper hand position requires one hand on the main handle (d).

Variable Speed Trigger Switch (fig. 1)

To turn the tool on, squeeze the trigger switch (a). To turn the tool off, release the trigger switch. Your tool is equipped with a brake. The anvil will stop when the trigger switch is fully released. The variable speed switch enables you to select the best speed for a particular application. The more you squeeze the trigger, the faster the tool will operate. For maximum tool life, use variable speed only for starting holes or fasteners.

NOTE: Continuous use in variable speed range is not recommended. It may damage the switch and should be avoided.

Forward/Reverse Control Button (fig. 1)

A forward/reverse control button (b) determines the direction of the tool and also serves as a lock-off button.

To select forward rotation, release the trigger switch and depress the forward/reverse control button on the right side of the tool.

To select reverse, release the trigger switch and depress the forward/reverse control button on the left side of the tool.

The center position of the control button locks the tool in the off position. When changing the position of the control button, be sure the trigger is released.

NOTE: The first time the tool is run after changing the direction of rotation, you may hear a click on start up. This is normal and does not indicate a problem.

Worklight (fig. 1)

There is a worklight (g) located on the foot of the tool. The worklight is activated when the trigger switch is depressed. When the trigger is released, the worklight will stay illuminated for up to 20 seconds.

NOTE: The worklight is for lighting the immediate work surface and is not intended to be used as a flashlight.

Anvil (fig. 2)



WARNING: Use only impact accessories. Non-impact accessories may break and cause a hazardous condition. Inspect accessory prior to use to ensure that it contains no cracks.



CAUTION: Inspect anvils, detent pins, and hog rings prior to use. Missing or damaged items should be replaced before use.

Place the switch in the locked off (center) position or remove battery pack before changing accessories.

ANVIL WITH DETENT PIN (FIG. 2)

To install an accessory on the anvil, align the hole in the side of the accessory with the detent pin (h) on the anvil (c). Press the accessory on until the detent pin engages in the hole. Depression of detent pin may be necessary to aid installation of accessory.

To remove an accessory, depress the detent pin through the hole and pull the accessory off.

ANVIL WITH HOG RING (FIG. 3)

DCF899H

To install an accessory on the hog ring anvil, firmly push accessory onto the anvil (c). The hog ring (l) compresses to allow the accessory to slide on. After accessory is installed, the hog ring applies pressure to help provide accessory retention.

To remove an accessory, grasp the accessory and firmly pull it off.

Usage

- Place the accessory on the fastener head. Keep the tool pointed straight at the fastener.
- Press switch to start operation. Release switch to stop operation. Always check torque with a torque wrench, as the fastening torque is affected by many factors including the following:
 - Voltage:** Low voltage, due to a nearly discharged battery, will reduce fastening torque.
 - Accessory size:** Failure to use the correct accessory size will cause a reduction in fastening torque.
 - Bolt size:** Larger bolt diameters generally require higher fastening torque. Fastening torque will also vary according to length, grade, and torque coefficient.
 - Bolt:** Ensure that all threads are free of rust

and other debris to allow proper fastening torque.

- Material:** The type of material and surface finish of the material will affect fastening torque.
- Fastening time:** Longer fastening time results in increased fastening torque. Using a longer fastening time than recommended could cause the fasteners to be overstressed, stripped or damaged.

MAINTENANCE

Your DEWALT power tool has been designed to operate over a long period of time with a minimum of maintenance. Continuous satisfactory operation depends upon proper tool care and regular cleaning.



WARNING: To reduce the risk of serious personal injury, place the forward/reverse button in the lock-off position or turn tool off and disconnect battery pack before making any adjustments or removing/installing attachments or accessories. An accidental start-up can cause injury.

The charger and battery pack are not serviceable. There are no serviceable parts inside.



Lubrication

Your power tool requires no additional lubrication.



Cleaning



WARNING: Blow dirt and dust out of the main housing with dry air as often as dirt is seen collecting in and around the air vents. Wear approved eye protection and approved dust mask when performing this procedure.



WARNING: Never use solvents or other harsh chemicals for cleaning the non-metallic parts of the tool. These chemicals may weaken the materials used in these parts. Use a cloth dampened only with water and mild soap. Never let any liquid get inside the tool; never immerse any part of the tool into a liquid.

CHARGER CLEANING INSTRUCTIONS



WARNING: Shock hazard. Disconnect the charger from the AC outlet before cleaning. Dirt and grease may be removed from the exterior of the charger using a cloth or soft non-metallic brush. Do not use water or any cleaning solutions.

Optional Accessories



WARNING: Since accessories, other than those offered by DEWALT, have not been tested with this product, use of such accessories with this tool could be hazardous. To reduce the risk of injury, only DEWALT recommended accessories should be used with this product.



WARNING: To reduce the risk of injury, only use DEWALT impact-ready accessories.



WARNING: Use only impact accessories. Non-impact accessories may break and cause a hazardous condition. Inspect accessories prior to use to ensure that they contain no cracks.

Consult your dealer for further information on the appropriate accessories.

Protecting the Environment



Separate collection. This product must not be disposed of with normal household waste.

Should you find one day that your DEWALT product needs replacement, or if it is of no further use to you, do not dispose of it with household waste. Make this product available for separate collection.



Separate collection of used products and packaging allows materials to be recycled and used again. Re-use of recycled materials helps prevent environmental pollution and reduces the demand for raw materials.

Local regulations may provide for separate collection of electrical products from the household, at municipal waste sites or by the retailer when you purchase a new product.

DEWALT provides a facility for the collection and recycling of DEWALT products once they have reached the end of their working life. To take advantage of this service please return your product

to any authorised repair agent who will collect them on our behalf.

You can check the location of your nearest authorised repair agent by contacting your local DEWALT office at the address indicated in this manual. Alternatively, a list of authorised DEWALT repair agents and full details of our after-sales service and contacts are available on the Internet at: www.2helpU.com.



Rechargeable Battery Pack

This long life battery pack must be recharged when it fails to produce sufficient power on jobs which were easily done before. At the end of its technical life, discard it with due care for our environment:

- Run the battery pack down completely, then remove it from the tool.
- Li-Ion cells are recyclable. Take them to your dealer or a local recycling station. The collected battery packs will be recycled or disposed of properly.

无线冲击扳手

DCF889、DCF889H

恭喜！

您已选择了得伟工具。凭借多年的经验和不懈的产品开发与创新，得伟已经成为专业电动工具用户的最可靠伙伴之一。

技术参数

| | | DCF889、DCF889H |
|------------|---------------------------|----------------|
| 电压 | V_{DC} | 18 |
| 电池类型 | | 锂离子 |
| 空载速度 | min^{-1} | 0-1500 |
| 冲击率 | $\text{m}^{-1} \text{ i}$ | 0-2300 |
| 重量 (不含电池组) | kg | 2.5 |

| 电池组 | | DCB180 | DCB181 | DCB182 | DCB184 |
|------|----------|--------|--------|--------|--------|
| 电池类型 | | 锂离子 | 锂离子 | 锂离子 | 锂离子 |
| 电压 | V_{DC} | 18 | 18 | 18 | 18 |
| 电容 | A_h | 3.0 | 1.5 | 4.0 | 5.0 |
| 重量 | kg | 0.64 | 0.35 | 0.61 | 0.63 |

| 充电器 | | DCB105 | |
|--------|----------|-----------------------------|-----------------------------|
| 电源电压 | V_{AC} | 220 | |
| 电池类型 | | 锂离子 | |
| 大约充电时间 | min | 30 (1.5 Ah 安时电池组) | 55 (3.0 Ah 安时电池组) |
| | | 70 (4.0 Ah 安时电池组) | 90 (5.0 Ah 安时电池组) |
| 重量 | kg | 0.49 | |

定义：安全指南

下列定义解释了各警示词的严重程度。请仔细阅读本手册，并注意警示符号的出现。



危险：表示紧急的危险情形，如不加以避免，**将导致死亡或严重伤害。**



警告：表示潜在的危险情形，如不加以避免，**可能导致死亡或严重伤害。**



警示：表示潜在的危险情形，如不加以避免，**可能导致轻度或中度伤害。**

注意：表示不涉及人身伤害的情况，如不加以避免，**可能导致财产损失。**



指示有触电风险。



指示存在火灾风险。



警告：为了减少受伤的危险，请阅读使用手册。

电动工具通用安全警告



警告：阅读所有警告和所有说明。不遵照以下警告和说明会导致电击、着火和/或严重伤害。

保存所有警告和说明书 以备查阅。

在所有下列的警告中术语“电动工具”指市电驱动（有线）电动工具或电池驱动（无线）电动工具。

a) 工作场地的安全

- 1) **保持工作场地清洁和明亮。**混乱和黑暗的场地会引发事故。
- 2) **不要在易爆环境，如有易燃液体、气体或粉尘的环境下操作电动工具。**电动工具产生的火花会点燃粉尘或气体。
- 3) **让儿童和旁观者离开后操作电动工具。**注意力不集中会使你失去对工具的控制。

b) 电气安全

- 1) **电动工具插头必须与插座相配。绝不能以任何方式改装插头。**需接地的电动工具不能使用任何转换插头。未经改装的插头和相配的插座将减少电击危险。
- 2) **避免人体接触接地表面，如管道、散热片和冰箱。**如果你身体接地会增加电击危险。
- 3) **不得将电动工具暴露在雨中或潮湿环境中。**水进入电动工具将增加电击危险。
- 4) **不得滥用电线。**绝不能用电线搬运、拉动电动工具或拔出其插头。使电线远离热源、油、锐边或运动部件。受损或缠绕的软线会增加电击危险。
- 5) **当在户外使用电动工具时，使用适合户外使用的外接软线。**适合户外使用的软线将减少电击危险。
- 6) **如果在潮湿环境下操作电动工具是不可避免的，应使用剩余电流动作保护器（RCD）。**使用RCD可减小电击危险。

c) 人身安全

- 1) **保持警觉，当操作电动工具时关注所从事的操作并保持清醒。**当你感到疲倦，或在有药物、酒精或治疗反应时，不要操作电动工具。在操作电动工具时瞬间的疏忽会导致严重人身伤害。
- 2) **使用个人防护装置。始终佩戴护目镜。**安全装置，诸如适当条件下使用防全面具、防滑安全鞋、安全帽、听力防护等装置能减少人身伤害。
- 3) **防止意外启动。确保开关在连接电源和/或电池盒、拿起或搬运工具时处于关断位置。**手指放在已接通电源的开关上或开关处于接通时插入插头可能会导致危险。

- 4) **在电动工具接通之前，拿掉所有调节钥匙或扳手。**遗留在电动工具旋转零件上的扳手或钥匙会导致人身伤害。
- 5) **手不要伸展得太长。时刻注意立足点和身体平衡。**这样在意外情况下能很好地控制电动工具
- 6) **着装适当。不要穿宽松衣服或佩戴饰品。让你的衣服、手套和头发远离运动部件。**宽松衣服、佩饰或长发可能会卷入运动部件中。
- 7) **如果提供了与排屑、集尘设备连接用的装置，要确保他们连接完好且使用得当。**使用这些装置可减少尘屑引起的危险。

d) 电动工具使用和注意事项

- 1) **不要滥用电动工具，根据用途使用适当的电动工具。**选用适当设计的电动工具会使你工作更有效、更安全。
- 2) **如果开关不能接通或关断工具电源，则不能使用该电动工具。**不能用开关来控制的电动工具是危险的且必须进行修理。
- 3) **在进行任何调节、更换附件或贮存电动工具之前，必须从电源上拔掉插头和/或使电池盒与工具脱开。**这种防护性措施将减少工具意外启动的危险。
- 4) **将闲置不用的电动工具贮存在儿童所及范围之外，并且不要让不熟悉电动工具或对这些说明不了解的人操作电动工具。**电动工具在未经培训的用户手中是危险的。
- 5) **保养电动工具。检查运动件是否调整到位或卡住，检查零件破损情况和影响电动工具运行的其他状况。**如有损坏，电动工具应在使用前修理好。许多事故由维护不良的电动工具引发。
- 6) **保持切削刀具锋利和清洁。**保养良好的有锋利切削刃的刀具不易卡住而且容易控制。
- 7) **按照使用说明书，考虑作业条件和进行的作业来使用电动工具、附件和工具的刀头等。**将电动工具用于那些与其用途不符的操作可能会导致危险。

e) 电池式工具使用和注意事项：

- 1) **只用制造商规定的充电器充电。**将适用于某种电池盒的充电器用到其他电池盒时会发生着火危险。
- 2) **只有在配有专用电池盒的情况下才使用电动工具。**使用其他电池盒会发生损坏和着火危险。
- 3) **当电池盒不用时，将它远离其他金属物体，例如回形针、硬币、钥匙、钉子、螺钉或其他小金属物体，以防一端与另一端连接。**电池端部短路会引起燃烧或火灾。

- 4) 在滥用条件下，液体会从电池中溅出，避免接触。如果意外碰到了，用水冲洗。如果液体碰到了眼睛，还要寻求医疗帮助。从电池中溅出的液体会发生腐蚀或燃烧。

f) 维修

- 1) 让专业维修人员使用相同的备件维修电动工具。这将保证所维修的电动工具的安全。

冲击扳手的附加安全说明

- 在紧固件可能触及暗线或自身软线之处进行操作时，要通过绝缘握持面来握持工具。紧固件碰到带电导线会使工具外露的金属零件带电从而使操作者受到电击。
- 使用夹具或采取其它可行的方法，将工件固定、支撑到稳定的平台上。手持或用身体顶住工件都是不稳定的，会导致操作失控。
- 请佩戴安全护目镜或其它护目装备。冲击或钻孔会导致碎片飞散。飞散的颗粒会对眼睛造成永久性伤害。
- 钻头、套筒和工具会在使用过程中发热。接触时请佩戴手套。
- 不要长时间操作此工具。工具运行导致的振动可能会伤害您的手和手臂。使用手套提供额外的衬垫保护。

剩余风险

尽管遵守了相关的安全法规并采用安全装备，某些剩余风险仍然是无法避免的。这些风险包括：

- 听力损伤。
- 四射的物品引起的人身伤害。
- 使用时配件发热导致的灼伤风险。
- 长时间的使用引起的人身伤害。

工具上的标识

工具有下列标志：



使用前请阅读使用手册。

日期码的位置

包含制造年份的日期码印在工具外壳上，位置介于工具和电池之间的接合处。

例如：

制造年份：

2013 XX XX

针对所有电池充电器的重要安全说明

请妥善保管好这些说明：本手册包含重要的 DCB105 电池充电器安全和操作说明。

- 使用充电器之前，请阅读所有说明和充电器、电池组以及电池组产品上的警示标记。



警告： 触电危险。禁止让任何液体进入充电器，否则会引起触电。



警示： 灼伤危险。为了减少受伤的危险，只使用得伟充电式电池组充电。其它类型的电池可能会过热爆裂，造成人身伤害和财产损失。



警示： 必须监督小孩，确保他们没有玩弄器具。

注意： 在某些情况下，当充电器的插头插入电源插座时，充电器内部裸露的充电接触点可能因为外来物件而短路。请勿让能导电的异物靠近充电器腔，这些异物包括但不限于钢棉、铝箔或任何金属颗粒的堆积物。充电器腔中没有电池组时，请断开充电器和电源。清洗前请拔掉充电器。

- 不要使用本手册指定充电器以外的其他任何充电器为电池组充电。充电器和电池组经特别设计以便配合工作。
- 除了为得伟充电式电池充电以外，这些充电器并非设计用于其他用途。其他用途可能会导致火灾、电击或触电死亡。
- 请勿将充电器暴露于雨中或雪中。
- 断开充电器连接时应拔下插头，切勿拉拽电线。这将减低对插头和电源线的损害风险。
- 确保电源线布置在不易踩踏、踢绊、拉扯或会受到损害或压力的位置。

- **不得使用延长电源线，除非有绝对的必要。**使用不正确的延长电源线可能导致火灾、触电或电击死亡的风险。
- **户外操作充电器时，要保持干燥，使用适合户外使用的延长线。**适合户外使用的电线将减少触电危险。
- **禁止堵塞充电器上的通风槽。通风槽位于充电器的顶部和两侧。**将充电器置放在远离任何热源的位置。
- **操作充电器时，不得使用损坏的电源线或插头** — 必须立即将其更换。
- **禁止使用受过重击、掉落或以其他方式受损的充电器。**请将损坏的充电器送到授权的服务中心维修。
- **禁止拆卸充电器，请将需要检修或修理的充电器送到授权的服务中心。**错误的重装可能导致触电、电击死亡或火灾的风险。
- 损坏的电源线必须立即由制造商、服务代理或类似的合格人员进行更换以防止安全隐患。
- **清洁前请将充电器和插座断开。以减少触电的危险。**仅取出电池不会减少触电风险。
- **严禁**尝试将两个充电器连接在一起。
- **充电器额定电压是标准 220 伏特家用电压。禁止在任何其他电压下使用充电器。**这条规则不适用于车载充电器。

请妥善保存这些说明

充电器

DCB105 充电器可使用 10.8 伏特、14.4 伏特和 18 伏特锂离子 (DCB121、DCB123、DCB140、DCB141、DCB142、DCB180、DCB181 和 DCB182) 电池组。

该充电器无需调整，专为简易操作而设计。

充电程序 (图3)

1. 插入电池组前请将充电器插入到合适的 220 伏特插座。
2. 将电池组 (f) 插入到充电器中，确定电池组完全就位。红色 (充电中) 指示灯将不断闪烁，表





N38220 充电过程已经开始。

3. 红色灯持续亮起表示充电完成。此时电池组已完全充电，您可以使用电池组或将电池组留在充电器上。

注意：为了确保锂离子电池的最佳性能和寿命，在首次使用电池组之前必须将它完全充电。

充电程序

关于电池组的充电状态，请参阅下表。

| 充电状态 | |
|---|-----------------|
|  充电 | — — — — |
|  已完全充电 | ————— |
|  热/冷电池组延迟 | — • — • — • — • |
|  电池组或充电器故障 | •••••••••• |
|  电源线故障 | •••••••• |

这个充电器不能为故障电池组充电。充电器指示灯不亮或“故障电池组或充电器”指示灯闪烁时，表示电池有故障。

注意：这也可能意味充电器有故障。如果充电器提示有故障存在，请将充电器和电池组送到授权的服务中心进行测试。

热/冷电池组延迟

当充电器检测到电池过热或过冷时，它会自动启动热/冷电池延迟模式，暂停充电，直到电池达到适当的温度。然后，充电器会自动切换到电池组充电模式。此功能可确保电池拥有最长的使用寿命。

XR 锂电池工具的设计带有防止电池超载、过热或深度放电的电子保护系统。

如果电子保护系统处于运作状态，该工具将自动停止运转。如果发生这种情况，请将锂电池放在充电器上直到完全充电。

冷电池组充电速率是温热的电池组充电速率的一半左右。电池组在整个充电周期的充电速度都会较慢，即使电池升温也不会返回到最高速度。

针对所有电池组的重要安全说明

在订购替换电池组时，请务必附上目录号码和电压。

包装箱内的电池组并未完全充电。在使用电池组和充电器之前，请阅读下面的安全说明，然后按照充电程序进行操作。

请阅读所有指示

- **禁止在易爆环境中充电或使用电池组，如有易燃液体、气体或粉尘的环境。** 插入或取出电池组时可能会点燃粉尘或烟雾。
- **切勿将电池组强行插入充电器。禁止以任何方式改装电池组并将电池组插入不兼容的充电器，这种操作可能会导致电池组破裂，造成严重的人身伤害。**
- 只使用指定的得伟充电器为电池组充电。
- **禁止喷溅或沉浸在水或其他液体中。**
- **禁止在温度可能达到或超过 40°C(105°F) 的地方（如夏天户外的棚子或金属建筑物中）存储或使用工具和电池组。**
- 为达到最佳效果，请确保电池组在使用前完全充电。



警告： 不论基于任何理由，都不要尝试打开电池组。电池组外壳破裂或损坏时，禁止将电池组插入充电器。请勿挤压、掉落或损坏电池组。禁止使用受过强烈重击、掉落、碾压或以任何其他方式（如被钉子穿破、受到锤子的重击、踩踏）受损的电池组或充电器。否则会引起触电或电击。损坏的电池组应交回服务中心回收。



警告： 放置不用时，将工具侧放在平稳的表面上，确保不会导致踢绊或掉落的风险。一些具有大型电池组的工具的电池组可以直立但可能会轻易被撞到。

锂离子的附加安全指示

- **即使电池组严重受损或完全损坏，也不要焚化电池组。** 电池组可能会在火中爆炸。锂离子电池在燃烧时会释放有毒烟雾和物质。
- **如果皮肤接触到电池内部物质，请立即用温和肥皂和水冲洗接触的地方。** 如果电池液沾到眼

睛，应睁开眼睛用清水冲洗至少 15 分钟或直到眼睛不会感到刺激为止。如果需要医疗救助，请告知医护人员：电池电解质是由液状有机碳酸盐和锂盐的混合物组成。

- **已打开电池的内部物质可能导致呼吸道刺激。** 提供新鲜空气。如果症状持续，请寻求医疗帮助。



警告： 灼伤危险。电池液如果接触到火花或火焰可能会燃烧。

电池组

电池类型

DCF889 使用 18 伏特电池组。

可以使用 DCB180、DCB181 或 DCB182 电池组。更多信息，请参阅**技术参数**。

存储建议

1. 最好将电池存放在阴凉、干燥、远离阳光直射、不会过热或过冷的地方。为了获得最佳的电池性能和使用寿命，在不使用时请将电池组存储在室温下。
2. 长期存储时，建议将完全充电的电池组从充电器取出，存储在阴凉、干燥的地方，以达到电池组的最佳性能。

注意： 电池组存储时不能处于电荷完全耗尽的状态。在使用电池组之前，电池组必须重新充电。

充电器和电池组上的标签

除了在本手册中使用的标志，充电器和电池组的标签还包括：



使用前请阅读使用手册。



电池充电中。



电池已充电。



热/冷电池组延迟。



电池组或充电器故障。



电源线故障。



切勿插入任何导电物件。



不要对损坏的电池组充电。



只使用得伟电池组。其他电池组可能会爆炸，造成人身伤害和损害。



不要暴露在水中。



应立即替换故障的电源线。



只在 4°C 和 40°C 之间的温度下充电。



弃置电池组时，请妥善处理以保护我们的环境。



禁止焚烧电池组。



为锂离子电池组充电。



充电时间详细信息请参阅**技术参数**。



只能在室内使用。

包装内容

本产品包装内含有：

- 1 冲击扳手
- 1 充电器
- 2 电池 1
- 1 维修箱
- 1 使用手册

注意：N-型号不包括电池组、充电器和维修箱。

- 检查工具、部件或配件是否在运输过程中损坏。
- 操作前请花时间仔细阅读和理解本手册。

说明 (图1、2)



警告：切勿修改本电动工具或其任何部件。否则可能导致损失或人身伤害。

- a. 触发开关
- b. 正转/反转控制按钮
- c. 铁砧
- d. 主握柄
- e. 电池释放按钮
- f. 电池组
- g. 工作灯
- h. 定位销(DCF889)
- i. 猪环扣
- j. 电量计(图5)

预期用途

本冲击扳手设计用于专业冲击锁紧用途。冲击功能使这个工具非常有用，特别是在木材、金属和混凝土中钻紧固件这方面。

禁止在潮湿或存在易燃液体、气体的环境中使用本工具。

这些重型冲击扳手/起子是专业型电动工具。**禁止**让儿童接触本工具。缺乏经验的操作员需要在监督下使用此工具。

- 本产品不适合身体、感官或心智能力有缺陷以及缺乏经验、知识或技能的人员（包括儿童）使用，除非有人负责他们的安全监督。请勿在无人监管的情况下让儿童触及本产品。

电气安全



本充电器为双重绝缘，因此无须接地线。请务必确认电源电压是否与标牌上标明的电压一致。



警告：如电源线损坏，必须用一条通过服务部门购得的专门制备软线来更换。

如电源线由具备同等资格但未经史丹利授权的人士更换，则产品质保将无效。

使用延长线

除非绝对必要，否则请勿使用延长线。请使用与充电器功率输入（见**技术数据**）匹配的、经过认证的延长线。最小导体尺寸为 1 平方毫米，最大长度为 30 米。

当使用电缆卷筒时，请务必完全卷出电缆。

组装与调整



警告： 组装与调整之前，必须取出电池组。插入或取出电池组之前，请关闭工具电源。



警告： 只能使用得伟电池组和充电器。

插入和拆除电池组 (图 4)



警告： 为了减少严重人身伤害的危险，调整或拆卸/安装附件或配件之前，请将**正转/反转控制按钮锁定在关闭位置，或请务必关闭工具电源，断开电池组。**意外启动容易导致严重的人身伤害。

注意： 请确保您的电池组 (f) 已完全充电。

要将电池组安装在工具手柄中

1. 将电池组 (f) 对齐工具手柄内的轨道 (图 4)。
2. 将电池组滑入手柄内，使其牢牢地固定在工具内，并确保不会脱离。

要从工具中取出电池组

1. 按电池释放按钮 (e)，并用力将电池组从工具手柄中拉出。
2. 按本手册充电器部分所述将电池组插入充电器中。

电池组电量计 (图 5)

一些得伟电池组带有包含三个绿色 LED 灯的电量计，可以指示电池组的剩余电量。

按下电量计按钮 (j) 不要松开，即可启动电量计。三个绿色 LED 灯的组合将亮起，以指示剩余电量。当电池内的电量等级低于可用限制时，电量计的照明状态将不会显示，电池组则必须重新充电。

注意： 电量计仅指示电池组的剩余电量。它并不表示该工具的功能，且将根据产品组件、温度和最终用户的使用情况而用所不同。

操作

使用说明



警告： 请务必遵守安全指示和适用的规则。



警告： 为了减少严重人身伤害的危险，调整或拆卸/安装附件或配件之前，请将**正转/反转控制按钮锁定在关闭位置，或请务必关闭工具电源，断开电池组。**意外启动容易导致严重的人身伤害。

正确的手持方式 (图 1、6)



警告： 为降低严重的人身伤害风险，始终使用正确的手部位置，如图所示。



警告： 为降低严重的人身伤害风险，始终紧握工具预防意外事件。

正确的手持方式如图所示，一只手要放在主握柄 (d) 上。

变速触发开关 (图 1)

开启该工具请按下触发开关 (a)。关闭工具请释放触发开关。您的工具配备制动器。触发开关完全释放时铁砧将停止运作。变速开关可让您根据特定用途选择最适用的速度。挤压开关越紧，工具运作越快。为了获得最大的工具使用寿命，只有在启动钻孔或紧固件时使用变速开关。

注意： 不建议持续使用变速。它可能会损坏开关，应加以避免。

正转/反转控制按钮 (图 1)

正转/反转控制按钮 (b) 确定工具方向，也有锁定按钮的功能。

选择向前旋转时，释放触发开关，按下工具右侧的正转/反转控制按钮。

要选择向后旋转，释放触发按钮然后将正反转控制按钮按压至工具左边。

控制按钮的中心位置会将工具锁定在关闭状态。改变控制按钮的位置时，确保触发开关处于释放状态。

注意：改变旋转方向后第一次运行该工具时，您可能在启动时听到“啪嗒声”。这是正常现象，而且并不表示出现问题。

工作灯 (图 1)

工作灯 (g) 位于工具的底座上。工作灯将在按压处罚按钮时被启动。触发开关被释放后，工作灯照明状态将停留 20 秒。

注意：工作灯用于照明直接的工作表面，并非设计作为闪光灯使用。

铁钻 (图 2)



警示：仅能使用冲击套筒。非冲击型套筒可能会破裂和导致危险情况。使用套筒之前，请检查套筒是否处于良好状态且无裂痕。



警示：使用前，请检查铁钻、定位削和猪扣环。使用前应更换遗失或损坏的物件。

更换附件之前，将开关锁定在关闭状态或拆除电池组。

铁钻与定位销 (图 2)

安装套筒至铁钻时，将套筒一侧的孔与铁钻上的定位销 (h) 对齐。按下套筒直至定位销插入孔中。必要时可对定位销施加压力，使套筒安装顺利。

若要拆除套筒，按下定位销，将套筒从孔中拉出。

带猪扣环的铁钻 (图 3)

将附件安装在猪扣环铁钻上时，请稳固地将附件推到铁钻 (c) 上。猪扣环 (i) 压缩以让附件在其上滑动。安装附件之后，猪扣环会施加压力以帮助固定附件。

拆除附件时请抓紧附件并稳固地将其取下。

用法

1. 将套筒放在紧固件的头部。保持工具和紧固件成直线。

2. 按下开关启动操作。释放开关停止操作。由于紧固扭矩受以下因素影响，请务必使用扭矩扳手检查扭矩：

- **电压：**低电压，几乎完全放电的电池会降低紧固扭矩。
- **套筒尺寸：**如果不使用正确的套筒尺寸，将使紧固扭矩变小。
- **螺栓尺寸：**螺栓直径越大，通常需要的紧固力矩越大。紧固扭矩也将随着长度、等级和扭矩系数的变化有所不同。
- **螺栓：**确保所有螺纹未生锈，没有其他杂物以产生适当的紧固扭矩。
- **材料：**材料的类型和材料的表面涂层都会影响紧固扭矩。
- **紧固时间：**紧固时间越长，紧固扭矩越大。如果紧固时间比建议的紧固时间长，可能会导致紧固件不堪重负、剥离或损坏。

维护

您的得伟电动工具设计精良，可以长期使用，仅需极少维护。连续令人满意的操作取决于适当的工具护理和定期清洁。



警告：为了减少严重人身伤害的危险，调整或拆卸/安装附件或配件之前，请将正转/反转控制按钮锁定在关闭位置，或请务必关闭工具电源，断开电池组。意外启动容易导致严重的人身伤害。

充电器和电池组都不能被维修。充电器和电池组内没有可以维修的部件。



润滑

本电动工具无需另行润滑。



清洁



警告：一旦看到通风口及其周围积聚了尘屑，请用干燥的空气将灰尘和尘屑从主机外壳内吹出。执行此过程时，需戴上经认可的护目装备和防尘口罩。



警告：切勿使用溶剂或其它刺激性化学制品来清洁工具的非金属部件。这些化学物质可能会削弱这些部位使用的材料。请用布蘸温和的肥皂水擦拭。切勿让任何液体进入工具，禁止让工具的任何部分在液体中浸泡。

充电器清洁说明



警告：触电危险。清洁前，请把充电器与交流电源插座断开。可用布或非金属软刷清除充电器外部的污垢和油脂。请勿使用水或任何清洁剂。

可选配件



警告：由于非得伟供应的配件未经本产品匹配测试，将此类配件用于本工具可能造成伤害。为降低伤害风险，本产品仅可使用得伟推荐的配件。



警告：为了减少受伤的风险，本产品只可使用得伟冲击型配件。

请向您的经销商咨询更多关于合适配件的信息。

环境保护



分类回收。本产品不得与普通家庭垃圾一起处理。



如果您发现您的得伟产品需要进行替换，或您已经不再需要使用这些产品，请不要将它们与家庭废物一起处理。请把它单独分类回收。



旧产品及包装的分类回收可使回收材料得以再度循环和利用。再循环材料的重新利用有助于防止环境污染和减少原料需求。

市政废物处理场或您购买新产品的零售商处会向您提供当地家用电器产品分类回收的有关规定。

得伟为结束使用期限的得伟产品提供了回收与再循环的设施。要充分利用这项服务，请将产品返回任何授权的维修代理，他们将代表我们回收您的产品。

您可通过联系本手册中所载的当地得伟办事处查询最靠近您的授权维修代理的位置。此外，您可以通过网站获得授权的得伟维修代理列表以及我们售后服务与联络方式的全部详情，网站地址：

www.2helpU.com。



充电式电池组

本长寿命电池组不能提供顺利完成工作所需的电力时必须进行充电。其电池技术寿命结束时，请妥善处理以保护我们的环境。

- 耗尽电池组的电力，然后从工具上拆下。

- 锂离子电池是可回收的。将它们送往您的经销商处或当地的回收站。回收的电池组将被妥善回收或处理。

制造商：百得墨西哥有限公司

**地 址：Avenida de los encinos #1, Parque
Industrial Villa Florida,
Reynosa Tamaulipas, 墨西哥, CP. 88780**

产 地：墨西哥