

DEWALT®

www.DEWALT.com

D25911

English (*original instructions*)

3

简体中文

9

Fig. A
图.A

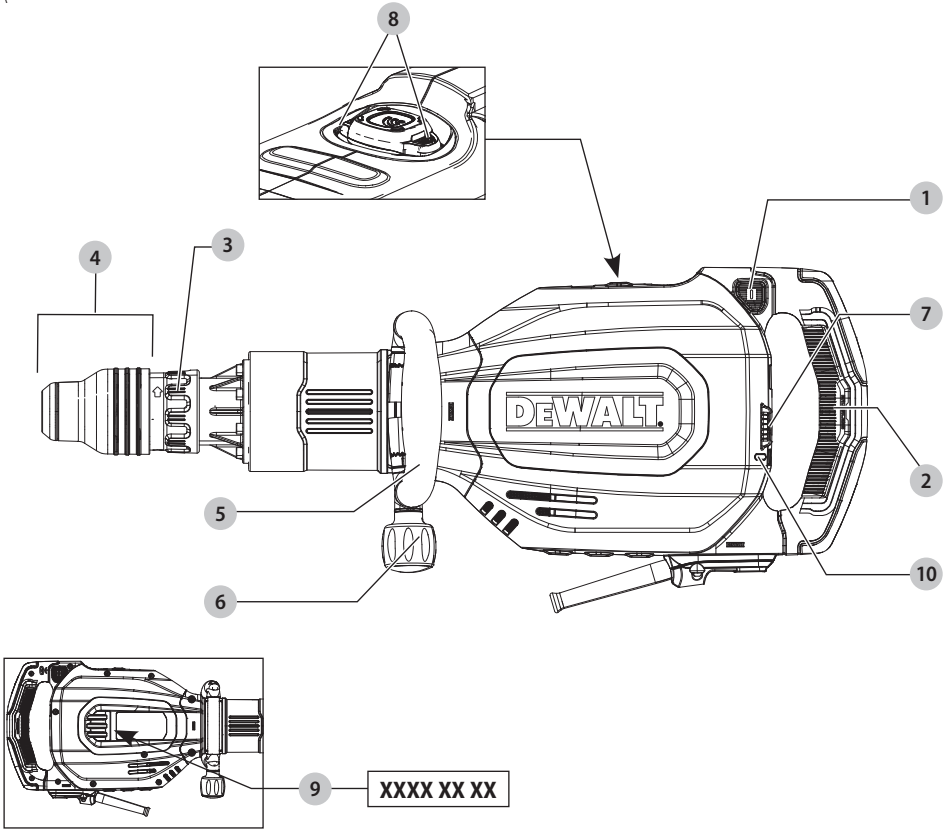

Fig. B
图.B

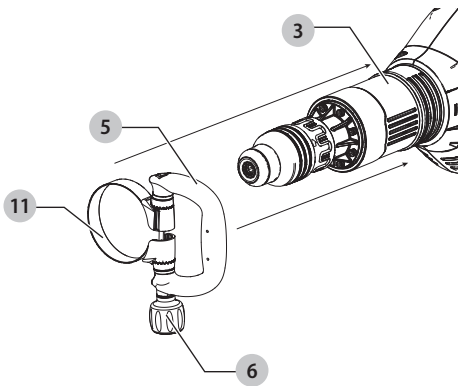

Fig. C
图.C

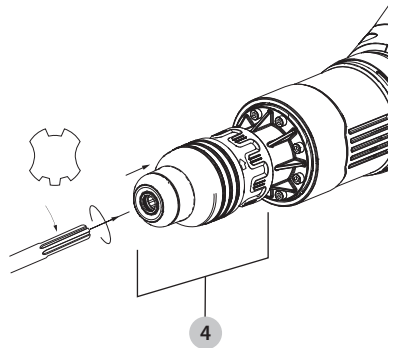

Fig. D
图. D

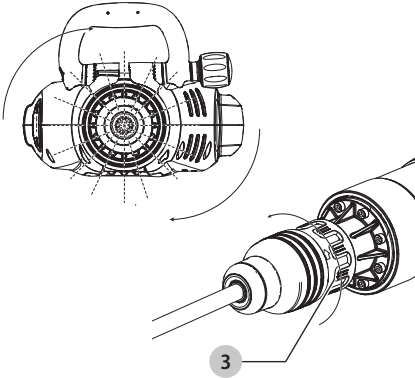

Fig. E1
图. E1

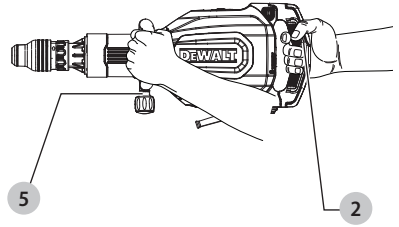

Fig. E2
图. E2

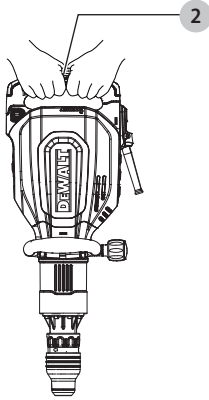

Fig. F
图. F

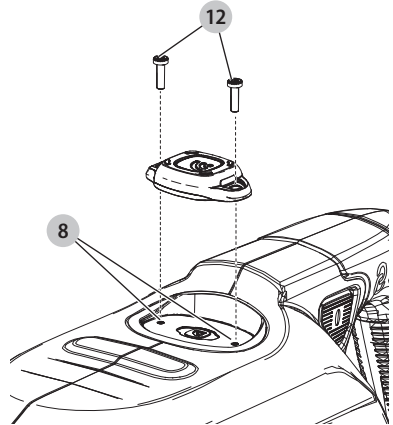
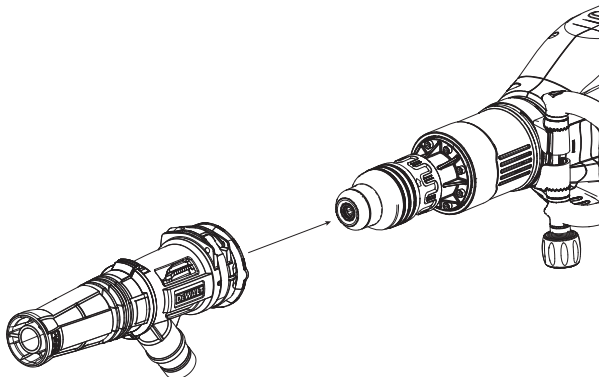

Fig. G
图. G



DEMOLITION HAMMER

D25911

Congratulations!

You have chosen a DEWALT tool. Years of experience, thorough product development and innovation make DEWALT one of the most reliable partners for professional power tool users.

Technical Data

	D25911	
Voltage	V _{ac}	220
Frequency	Hz	50
Power input	W	1700
No-Load beats per minute	bpm	810–1620
Single impact energy (EPTA 05/2009)	J	27
Tool holder	SDS max®	
Chisel positions	12	
Weight	kg	12.7



WARNING: To reduce the risk of injury, read the instruction manual.

Definitions: Safety Guidelines

The definitions below describe the level of severity for each signal word. Please read the manual and pay attention to these symbols.



DANGER: Indicates an imminently hazardous situation which, if not avoided, **will** result in **death or serious injury**.



WARNING: Indicates a potentially hazardous situation which, if not avoided, **could** result in **death or serious injury**.



CAUTION: Indicates a potentially hazardous situation which, if not avoided, **may** result in **minor or moderate injury**.

NOTICE: Indicates a practice **not related to personal injury** which, if not avoided, **may** result in **property damage**.



Denotes risk of electric shock.



Denotes risk of fire.

GENERAL POWER TOOL SAFETY WARNINGS



WARNING: Read all safety warnings, instructions, illustrations and specifications provided with this power tool. Failure to follow all instructions listed below may result in electric shock, fire and/or serious injury.

SAVE ALL WARNINGS AND INSTRUCTIONS FOR FUTURE REFERENCE

The term "power tool" in the warnings refers to your mains-operated (corded) power tool or battery-operated (cordless) power tool.

1) Work Area Safety

- Keep work area clean and well lit.** Cluttered or dark areas invite accidents.
- Do not operate power tools in explosive atmospheres, such as in the presence of flammable liquids, gases or dust.** Power tools create sparks which may ignite the dust or fumes.
- Keep children and bystanders away while operating a power tool.** Distractions can cause you to lose control.

2) Electrical Safety

- Power tool plugs must match the outlet. Never modify the plug in any way. Do not use any adapter plugs with earthed (grounded) power tools.** Unmodified plugs and matching outlets will reduce risk of electric shock.
- Avoid body contact with earthed or grounded surfaces, such as pipes, radiators, ranges and refrigerators.** There is an increased risk of electric shock if your body is earthed or grounded.
- Do not expose power tools to rain or wet conditions.** Water entering a power tool will increase the risk of electric shock.
- Do not abuse the cord. Never use the cord for carrying, pulling or unplugging the power tool. Keep cord away from heat, oil, sharp edges or moving parts.** Damaged or entangled cords increase the risk of electric shock.
- When operating a power tool outdoors, use an extension cord suitable for outdoor use.** Use of a cord suitable for outdoor use reduces the risk of electric shock.
- If operating a power tool in a damp location is unavoidable, use a residual current device (RCD) protected supply.** Use of an RCD reduces the risk of electric shock.

3) Personal Safety

- Stay alert, watch what you are doing and use common sense when operating a power tool. Do not use a power tool while you are tired or under the influence of drugs, alcohol or medication.** A moment of inattention while operating power tools may result in serious personal injury.
- Use personal protective equipment. Always wear eye protection.** Protective equipment such as a dust mask, non-skid safety shoes, hard hat or hearing protection used for appropriate conditions will reduce personal injuries.
- Prevent unintentional starting. Ensure the switch is in the off position before connecting to power source and/or battery pack, picking up or carrying the tool.** Carrying power tools with your finger on the switch or energising power tools that have the switch on invites accidents.

- d) **Remove any adjusting key or wrench before turning the power tool on.** A wrench or a key left attached to a rotating part of the power tool may result in personal injury.
- e) **Do not overreach. Keep proper footing and balance at all times.** This enables better control of the power tool in unexpected situations.
- f) **Dress properly. Do not wear loose clothing or jewellery. Keep your hair and clothing away from moving parts.** Loose clothes, jewellery or long hair can be caught in moving parts.
- g) **If devices are provided for the connection of dust extraction and collection facilities, ensure these are connected and properly used.** Use of dust collection can reduce dust-related hazards.
- h) **Do not let familiarity gained from frequent use of tools allow you to become complacent and ignore tool safety principles.** A careless action can cause severe injury within a fraction of a second.

4) Power Tool Use and Care

- a) **Do not force the power tool. Use the correct power tool for your application.** The correct power tool will do the job better and safer at the rate for which it was designed.
- b) **Do not use the power tool if the switch does not turn it on and off.** Any power tool that cannot be controlled with the switch is dangerous and must be repaired.
- c) **Disconnect the plug from the power source and/or remove the battery pack, if detachable, from the power tool before making any adjustments, changing accessories, or storing power tools.** Such preventive safety measures reduce the risk of starting the power tool accidentally.
- d) **Store idle power tools out of the reach of children and do not allow persons unfamiliar with the power tool or these instructions to operate the power tool.** Power tools are dangerous in the hands of untrained users.
- e) **Maintain power tools and accessories. Check for misalignment or binding of moving parts, breakage of parts and any other condition that may affect the power tool's operation. If damaged, have the power tool repaired before use.** Many accidents are caused by poorly maintained power tools.
- f) **Keep cutting tools sharp and clean.** Properly maintained cutting tools with sharp cutting edges are less likely to bind and are easier to control.
- g) **Use the power tool, accessories and tool bits, etc. in accordance with these instructions, taking into account the working conditions and the work to be performed.** Use of the power tool for operations different from those intended could result in a hazardous situation.
- h) **Keep handles and grasping surfaces dry, clean and free from oil and grease.** Slippery handles and grasping surfaces do not allow for safe handling and control of the tool in unexpected situations.

5) Service

- a) **Have your power tool serviced by a qualified repair person using only identical replacement parts.** This will ensure that the safety of the power tool is maintained.

Hammer Safety Warnings

- **Wear ear protectors.** Exposure to noise can cause hearing loss.
- **Use auxiliary handles, if supplied with the tool.** Loss of control can cause personal injury.
- **Hold the power tool by insulated gripping surfaces, when performing an operation where the cutting accessory may contact hidden wiring.** Cutting accessory contacting a "live" wire may make exposed metal parts of the power tool "live" and could give the operator an electric shock.

Additional Safety Instructions for Chiselling Hammers/Demolition hammers

- **Use clamps or other practical way to secure and support the workpiece to a stable platform.** Holding the work by hand or against your body is unstable and may lead to loss of control.
- **Wear safety goggles or other eye protection.** Hammering operations cause chips to fly. Flying particles can cause permanent eye damage. Wear a dust mask or respirator for applications that generate dust. Ear protection may be required for most applications.
- **Keep a firm grip on the tool at all times.** Do not attempt to operate this tool without holding it with both hands. It is recommended that the side handle be used at all times. Operating this tool with one hand will result in loss of control. Breaking through or encountering hard materials such as re-bar may be hazardous as well. Tighten the side handle securely before use.
- **Do not operate this tool for long periods of time.** Vibration caused by hammer action may be harmful to your hands and arms. Use gloves to provide extra cushion and limit exposure by taking frequent rest periods.
- **Do not recondition accessories yourself.** Chisel reconditioning should be done by a qualified specialist. Improperly reconditioned accessories could cause injury. Only slightly-worn chisels can be resharpened by grinding.
- **Do not overheat the bit (discoloration) while grinding a new edge.** Badly worn chisels require reforging. Do not reharden and temper the chisel.
- **Wear gloves when operating tool or changing bits.** Accessible metal parts on the tool and bits may get extremely hot during operation. Small bits of broken material may damage bare hands.
- **Never lay the tool down until the bit has come to a complete stop.** Moving bits could cause injury.
- **Do not strike jammed bits with a hammer to dislodge them.** Fragments of metal or material chips could dislodge and cause injury.

- **Make sure that there are no power or gas lines in the work area.** Damage to hidden power or gas lines can result in injury from electric shock or explosion.
- **When working above the floor, make sure that the area below is clear.** Falling parts can cause injuries to bystanders.
- **In cold weather or if the unit has not been used for a long time, run the unit without load for a few minutes before use.** High load in cold condition may cause damage to the demolition hammer.
- **Make sure that the chisel is secured before using the tool.** Ejected parts can cause injuries.

Reducing Dust Exposure

Before starting work, check the hazard class of the dust that will be produced when working.

-  **WARNING:** Avoid touching or breathing dust as it can be harmful to health. Dust created when using a power tool and when conducting other construction activities can contain chemicals, minerals, or particles known to cause respiratory infections, allergic reactions, cancer, birth defects, or other reproductive harm of the user or bystanders.
- Such dust can be generated, for example, when working on hardwoods such as beech or oak, lead-based paint, concrete, masonry, or stones containing quartz.
 - Material containing asbestos may be handled only by specialists.
 - Observe the relevant regulations in your country for the materials to be worked on.
 - Use a dust extractor or extraction system with an officially approved protection class in compliance with the locally applicable dust protection regulations and suitable for the material to be worked on.
 - Capture the resulting dust particles directly at the source and avoid deposits in the surrounding area. Use suitable extraction accessories for this purpose.

Additional measures:

- Make sure that the workplace is well ventilated.
- Wear a respirator appropriate for the type of dust generated.

Residual Risks

 **WARNING:** We recommend the use of a residual current device with a residual current rating of 30mA or less.

In spite of the application of the relevant safety regulations and the implementation of safety devices, certain residual risks cannot be avoided. These are:

- Impairment of hearing.
- Risk of personal injury due to flying particles.
- Risk of burns due to accessories becoming hot during operation.
- Risk of personal injury due to prolonged use.

SAVE THESE INSTRUCTIONS

Electrical Safety

The electric motor has been designed for one voltage only. Always check that the power supply corresponds to the voltage on the rating plate.



Your DEWALT tool is double insulated in accordance with IEC62841; therefore no earth wire is required.

If the supply cord is damaged, it must be replaced only by DEWALT or an authorised service organisation.

Using an Extension Cable

If an extension cable is required, use an approved 3-core extension cable suitable for the power input of this tool (refer to **Technical Data**). The minimum conductor size is 1.5 mm²; the maximum length is 30 m.

When using a cable reel, always unwind the cable completely.

Package Contents

The package contains:

- 1 Demolition hammer
- 1 Side handle
- 1 Chisel
- 1 Kitbox
- 1 Instruction manual
- Check for damage to the tool, parts or accessories which may have occurred during transport.
- Take the time to thoroughly read and understand this manual prior to operation.

Markings on Tool

The following pictograms are shown on the tool:



Read instruction manual before use.



Wear ear protection.



Wear eye protection.

Date Code Position (Fig. A)

The production date code **9** consists of a 4-digit year followed by a 2-digit week and is extended by a 2-digit factory code.

Description (Fig. A)



WARNING: Never modify the power tool or any part of it. Damage or personal injury could result.

- 1 On/off switch
- 2 Main handle
- 3 Chisel position index collar
- 4 Tool holder/sleeve
- 5 Bail/loop style auxiliary handle
- 6 Screw for handle mounting
- 7 Speed control dial

- 8 Tool Tag mounting holes
- 9 Date code
- 10 Yellow service indicator LED

Intended Use

Your heavy-duty demolition hammer is designed for breaking or demolishing concrete, masonry, stone and asphalt.

DO NOT use under wet conditions or in the presence of flammable liquids or gases.

Your heavy-duty demolition hammer is a professional power tool.

DO NOT let children come into contact with the tool. Supervision is required when inexperienced operators use this tool.

- **Young children and the infirm.** This appliance is not intended for use by young children or infirm persons without supervision.
- This product is not intended for use by persons (including children) suffering from diminished physical, sensory or mental abilities; lack of experience, knowledge or skills unless they are supervised by a person responsible for their safety. Children should never be left alone with this product.

ASSEMBLY AND ADJUSTMENTS

 **WARNING:** To reduce the risk of serious personal injury, turn tool off and disconnect tool from power source before making any adjustments or removing/installing attachments or accessories. An accidental start-up can cause injury.

Bail/Loop Style Auxiliary Handle (Fig. B)

 **WARNING:** To reduce the risk of personal injury, ALWAYS operate the tool with the bail/loop style auxiliary handle properly installed and securely tightened. Failure to do so may result in the bail/loop style auxiliary handle slipping during tool operation and subsequent loss of control. Hold tool with both hands to maximize control.

The bail/loop style auxiliary handle **5** clamps to the front of the gear case and may be rotated 360° to permit right- or left-hand use.

Mounting the Bail/Loop Style Auxiliary Handle (Fig. B)

1. Widen the ring opening **11** of the bail/loop style auxiliary handle **5** by rotating the screw for handle mounting **6** counterclockwise.
2. Slide the assembly onto the nose of the tool through the ring opening **11** and onto the chisel position index collar **3**, past the chisel holder and sleeve.
3. Rotate the bail/loop style auxiliary handle to the desired position.
4. Lock the bail/loop style auxiliary handle in place by securely tightening the screw for handle mounting **6**, rotating it clockwise so that the assembly will not rotate.

Chisel and Tool Holder

 **WARNING:** Burn hazard. ALWAYS wear gloves when changing chisels. Accessible metal parts on the tool and chisels may get extremely hot during operation. Small bits of broken material may damage bare hands.

Inserting and Removing SDS max® Accessories (Fig. C)

This machine uses SDS max® chisels (refer to the inset in Figure C for a cross-section of an SDS max® chisel shank).

1. Clean the chisel shank.

 **WARNING:** Do not apply lubricant to the machine.

2. Pull back the locking sleeve **4** and insert the chisel shank.
3. Release the locking sleeve and turn the chisel slightly until the locking sleeve snaps into position.
4. Pull on the chisel to check if it is properly locked. The hammering function requires the chisel to be able to move axially several centimetres when locked in the chisel holder.
5. To remove a chisel pull back the locking sleeve **4** and pull the chisel out of the tool holder **4**.

Indexing the Chisel Position (Fig. D)

The chisel can be indexed and locked into 12 different positions.

1. Insert the chisel as described above.
2. Rotate the chisel position index collar **3** in the direction of the arrow until the chisel is in the desired position.

Setting the Electronic Impact Energy Control Dial (Fig. A)

Turn the dial **7** to the desired level. The higher the number, the greater the impact energy. With dial settings from 1 (low) to 7 (full power) the tool is extremely versatile and adaptable for many different applications.

The required setting is a matter of experience, for example:

- When chiselling soft, brittle materials or when minimum break-out is required, set the dial to 1 or 2 (low);
- When breaking harder materials, set the dial to 7 (full power).

Service Indicator LED (Fig. A)

Your demolition hammer has yellow service indicator LED **10**, to indicate when service is required. Refer to the table for more information on LED functionality.

LED Function	Description
 Yellow (permanently on)	Service required The yellow service indicator LED 10 lights up to indicate the tool needs servicing within the next 10 hours of use (new lubrication and hammer mechanism sealing).

LED Function	Description
 Yellow (flashing)	Service exceeded With the service indicator lit, after a further 10 hours of use the service indicator flashes to indicate the tool has exceeded the required service interval.

Active Vibration Control (AVC) System

For best vibration control, hold the tool as described in **Proper Hand Position** and apply just enough pressure so the damping device on the main handle is approximately midstroke.

The active vibration control neutralises rebound vibration from the hammer mechanism. Lowering hand and arm vibration, it allows more comfortable use for longer periods of time and extends the life of the unit.

The hammer only needs enough pressure to engage the active vibration control. Applying too much pressure will not make the tool drill or chip faster and active vibration control will not engage.

Soft Start Feature

The soft start feature allows the tool to accelerate slowly, thus preventing the drill bit from walking off the intended hole position when starting.

The soft start feature also reduces the immediate torque reaction transmitted to the gearing and the operator if the hammer is started with the drill bit in an existing hole.

DeWALT Tool Tag Ready (Fig. F)

Optional Accessory

Your demolition hammer comes with Tool Tag mounting holes **8** and fasteners **12** for installing a DeWALT Tool Tag. You will need a T15 bit tip to install the tag.

 **WARNING:** Use only original fasteners. Longer screws increase the risk of electrical shock or damage to the tool.

The DeWALT Tool Tag is designed for tracking and locating professional power tools, equipment, and machines using the DeWALT Tool Connect™ app. For proper installation of the DeWALT Tool Tag refer to the DeWALT Tool Tag manual.

Dust Extraction System (Fig. G)

The use of a dust extraction system (DWH051) is recommended to reduce potentially harmful airborne dust and to prolong tool and accessory life.

Consult your dealer for further information on suitable dust extraction systems.

OPERATION

Instructions for Use

 **WARNING:** Always observe the safety instructions and applicable regulations.

 **WARNING:** To reduce the risk of serious personal injury, turn tool off and disconnect tool from power

source before making any adjustments or removing/installing attachments or accessories. An accidental start-up can cause injury.

 **WARNING:** Always observe the safety instructions and applicable regulations.

 **WARNING:** Be aware of the location of pipework and wiring.

 **WARNING:** Apply a pressure of approx. 44–66 lbs. (20–30 kg) to the tool. Excessive force does not speed up chiselling but decreases tool performance and may shorten tool life.

Proper Hand Position (Fig. E1, E2)

 **WARNING:** To reduce the risk of serious personal injury, ALWAYS use proper hand position as shown.

 **WARNING:** To reduce the risk of serious personal injury, ALWAYS hold securely in anticipation of a sudden reaction.

IMPORTANT: The tool must be held with two hands at all times when in use.

Horizontal Applications (Fig. E1)

Proper hand position requires one hand on the bail/loop style auxiliary handle **5** with the other hand on the main handle **2**.

Vertical Applications (Fig. E2)

Proper hand position requires both hands on the main handle **2**.

Switching On and Off (Fig. A)

Switching on: set the on/off switch **1** to position 1.

Switching off: set the on/off switch **1** to position 0.

Demolition (Fig. A)

 **WARNING:** Ensure that the cutting edge does not show discoloration caused by too much pressure. This may impair the hardness of the accessory.

Various types of chisels are available as an option.

1. Select the appropriate chisel. Clean the chisel shank.
2. Insert the chisel and check whether it is properly locked.
3. Set the desired impact energy level.
4. Fit and adjust the bail/loop style auxiliary handle **5** and make sure it is firmly tightened.
5. Hold the tool with main handle and switch on. The tool now runs in continuous operation.
IMPORTANT: ALWAYS use two hands when operating the tool. Refer to **Proper Hand Position** for the proper use of the tool for both horizontal and vertical applications.
6. Always switch off the tool when work is finished and before unplugging.

MAINTENANCE



Your power tool has been designed to operate over a long period of time with a minimum of maintenance. Continuous satisfactory operation depends upon proper tool care and regular cleaning.

-  **WARNING:** To reduce the risk of serious personal injury, turn tool off and disconnect tool from power source before making any adjustments or removing/installing attachments or accessories. An accidental start-up can cause injury.

Lubrication

Your power tool requires no additional lubrication.

Cleaning

-  **WARNING:** Electrical shock and mechanical hazard. Disconnect the electrical appliance from the power source before cleaning.
-  **WARNING:** To ensure safe and efficient operation, always keep the electrical appliance and the ventilation slots clean.
-  **WARNING:** Never use solvents or other harsh chemicals for cleaning the non-metallic parts of the tool. These chemicals may weaken the materials used in these parts. Use a cloth dampened only with water and mild soap. Never let any liquid get inside the tool; never immerse any part of the tool into a liquid.

Ventilation slots can be cleaned using a dry, soft non-metallic brush and/or a suitable vacuum cleaner. Do not use water or any cleaning solutions. Wear approved eye protection and an approved dust mask.

Transport

-  **CAUTION:** Accidental starting during transport!
- Always transport your tool with removed battery or disconnected power supply cord.
 - Check the tool for damage before use after transport.

Storage

- Before storage, remove the battery from the tool or disconnect the power supply cable from the mains.

- Clean the tool before storage. Refer to **Cleaning**.
- The storage place must be suitable for the weight of the tool.
- Store the tool in a cool and dry place.
- Store the tool in a place where they cannot be accessed by children or unauthorized persons.
- Check the tool for damage before use after long periods of storage.

Optional Accessories

-  **WARNING:** Since accessories, other than those offered by DEWALT, have not been tested with this product, use of such accessories with this tool could be hazardous. To reduce the risk of injury, only DEWALT-recommended accessories should be used with this product.

Consult your dealer for further information on the appropriate accessories.

Protecting the Environment

-  Separate collection. Products marked with this symbol must not be disposed of with normal household waste. Products contain materials that can be recovered or recycled, reducing the demand for raw materials. Please recycle electrical products according to local provisions. Further information is available at www.2helpU.com.

SDS plus® and SDS max® are registered trademarks of Robert Bosch GmbH.

After Service and Repair

DEWALT service centers are staffed with trained personnel to provide customers with efficient and reliable product service. We do not take any responsibility when you have repaired in unauthorized service center. You can refer to the leaflet of CONTACT CENTER LOCATOR in product package and contact us through hotline, website or social media to find the nearest DEWALT service center around you

TROUBLESHOOTING GUIDE

BE SURE TO FOLLOW SAFETY RULES AND INSTRUCTIONS

For assistance with your product, visit our website at www.dewalt.com for a list of service centres.

PROBLEM	POSSIBLE CAUSE	SOLUTION
Tool will not start.	The extension cord and/or plug is defective.	Have the extension cord and/or plug checked by a qualified electrician and replaced if necessary.
	Internal components are too hot.	Allow tool to cool down.
Reduced power.	The extension cord is too long and/or its gauge is inadequate.	Use an extension cord of an approved length and/or adequate gauge.
	The voltage provided by the electric supply is inadequate.	Connect the hammer to an adequate electric supply.
The chisel cannot be released.	The chuck is not pulled back fully.	Pull the chuck back as far as it will go and remove the chisel. Refer to Inserting and Removing SDS max® Accessories .

五坑凿破机

D25911

恭喜!

感谢您选购DEWALT工具。凭借多年的产品开发和创新能力，DEWALT已经成为专业电动工具用户最可靠的合作伙伴之一。

技术数据

		D25911
电压	V_{AC}	220
频率	Hz	50
额定功率	W	1700
锤击频率	bpm	810–1620
锤击能量 (EPTA 05/2009)	J	27
夹头类型		SDS max®
凿子位置		12
重量	kg	12.7



警告:为降低伤害风险, 请阅读使用手册。

定义:安全指南

下列定义描述了各标志术语的严重程度。请仔细阅读本手册, 并注意这些标志。



危险:表示存在紧急危险情况, 如果不加以避免, 将导致死亡或重伤。



警告:潜在的危险情况, 如果不加以避免, 可能导致死亡或重伤。



小心:表示存在潜在危险情况, 如果不加以避免, 可能导致轻度或中度伤害。

注意:与人身伤害无关的行为, 如果不加以避免, 可能导致财产损失。



表示存在触电风险。



表示存在火灾风险。

电动工具通用安全警告



警告!阅读随电动工具提供的所有安全警告、说明、图示和规定。不遵照以下所列说明会导致电击、着火和/或严重伤害。

保存所有警告和说明书以备查阅。

警告中的术语“电动工具”指市电驱动(有线)电动工具或电池驱动(无线)电动工具。

1) 工作场地的安全

- 保持工作场地清洁和明亮。杂乱和黑暗的场地会引发事故。
- 不要在易爆环境, 如有易燃液体、气体或粉尘的环境下操作电动工具。电动工具产生的火花会点燃粉尘或气体。

- 操作电动工具时, 远离儿童和旁观者。注意力不集中会使你失去对工具的控制。

2) 电气安全

- 电动工具插头必须与插座相配。绝不能以任何方式改装插头。需接地的电动工具不能使用任何转换插头。
未经改装的插头和相配的插座将降低电击风险。
- 避免人体接触接地表面, 如管道、散热片和冰箱。如果你身体接触接地表面会增加电击风险。
- 不得将电动工具暴露在雨中或潮湿环境中。
水进入电动工具将增加电击风险。
- 不得滥用软线。绝不能用软线搬运、拉动电动工具或拔出其插头。使软线远离热源、油、锐边或运动部件。受损或缠绕的软线会增加电击风险。
- 当在户外使用电动工具时, 使用适合户外使用的延长线。适合户外使用的电线将降低电击风险。
- 如果无法避免在潮湿环境下操作电动工具, 应使用带有剩余电流装置(RCD)保护的电源。RCD的使用可降低电击风险。

3) 人身安全

- 保持警觉, 当操作电动工具时关注所从事的操作并保持清醒。当你感到疲倦, 或在有药物、酒精或治疗反应时, 不要操作电动工具。在操作电动工具时瞬间的疏忽会导致严重人身伤害。
- 使用个人防护设备。始终佩戴护目镜。防护装置, 诸如适当条件下使用防尘面具、防滑安全鞋、安全帽、听力防护等装置能减少人身伤害。
- 防止意外起动。在连接电源和/或电池包、拿起或搬运工具前确保开关处于关断位置。手指放在开关上搬运工具或开关处于接通时通电会导致危险。
- 在电动工具接通之前, 拿掉所有调节钥匙或扳手。遗留在电动工具旋转零件上的扳手或钥匙会导致人身伤害。
- 手不要过分伸展。时刻注意立足点和身体平衡。这样能在意外情况下能更好地控制住电动工具。
- 着装适当。不要穿宽松衣服或佩戴饰品。让你的头发和衣服远离运动部件。宽松衣服、佩戴或长发可能会卷入运动部件。
- 如果提供了与排屑、集尘设备连接用的装置, 要确保其连接完好且使用得当。使用集尘装置可降低尘屑引起的危险。
- 不要因为频繁使用工具而产生的熟悉感而掉以轻心, 忽视工具的安全准则。某个粗心的动作可能在瞬间导致严重的伤害。

4) 电动工具使用和注意事项

- 不要勉强使用电动工具, 根据用途使用合适的电动工具。选用合适的按照额定值设计的电动工具会使你工作更有效、更安全。
- 如果开关不能接通或关断电源, 则不能使用该电动工具。不能通过开关来控制的电动工具是危险的且必须进行修理。

- c) 在进行任何调节、更换附件或贮存电动工具之前，必须从电源上拔掉插头和/或卸下电池包(如可拆卸)。这种防护性的安全措施降低了电动工具意外起动的风险。
- d) 将闲置不用的电动工具贮存在儿童所及范围之外，并且不允许不熟悉电动工具和不了解这些说明的人操作电动工具。电动工具在未经培训的使用者手中是危险的。
- e) 维护电动工具及其附件。检查运动部件是否调整到位或卡住，检查零件破损情况和影响电动工具运行的其他状况。如有损坏，应在使用前修理好电动工具。许多事故是由维护不良的电动工具引发的。
- f) 保持切削刀具锋利和清洁。维护良好地有锋利切削刃的刀具不易卡住而且容易控制。
- g) 按照使用说明书，并考虑作业条件和要进行的作业来选择电动工具、附件和工具的刀头等。将电动工具用于那些与其用途不符的操作可能会导致危险情况。
- h) 保持手柄和握持表面干燥、清洁，不得沾有油脂。在意外的情况下，湿滑的手柄不能保证握持的安全和对工具的控制。

5) 维修

- a) 让专业维修人员使用相同的备件维修电动工具。这将保证所维修的电动工具的安全。

锤类工具安全警告

- 戴好耳罩。暴露在噪声中会引起听力损伤。
- 使用随工具提供的辅助手柄。操作失手会引起人身伤害。
- 进当在切削附件可能触及暗线或其自身软线之处进行操作时，要通过绝缘握持面来握持工具。切削附件碰到带电导线会使工具外露的金属零件带电从而使操作者受到电击。

凿破机的其他安全说明

- 使用夹具或其他切实可行的方法，将工件固定并支撑在稳定的平台上。用手扶住或身体顶住工件是不稳定的，可能导致失控。
- 戴上安全护目镜或其他护眼装置。锤击操作会导致碎片飞溅。飞溅的颗粒会对眼睛造成永久性伤害。在扬尘的应用中，要戴上防尘面具或呼吸器。在大多数应用中，可能需要保护耳朵。
- 任何时候都要牢牢抓住工具。请勿在没有用双手握住工具前操作工具。建议在任何时候都握住侧手柄。单手操作本工具将导致失控。破碎或遇到坚硬的材料时(如钢筋)，可能会引发危险。使用前，请紧固侧手柄。
- 请勿长时间操作本工具。由锤击操作引起的振动可能对您的手和胳膊造成伤害。佩戴手套来增加缓冲，并时不时休息，以减少遭受的振动量。
- 请勿自行修理配件。应由合格的专家来修理凿子。配件如果修理不当，可能会造成伤害。只有轻微磨损的凿子可以通过打磨进行修整。

- 打磨钻头时，请勿使刀头过热(变色)。磨损严重的凿子需要重新锻造。请勿对凿子进行重新硬化和回火。
- 操作工具或更换刀头时要戴上手套。操作过程中，工具和刀头上可触及的金属部件可能会变得非常热。小块的破碎材料可能会划伤手部皮肤。
- 在钻头完全停止之前，切勿放下电动工具。移动的钻头可能会造成伤害。
- 请勿用锤子敲打卡住的钻头，以使其移开。金属碎片或材料碎片可能脱落，并造成伤害。
- 确保工作区域内没有电源或燃气管道。损坏隐蔽的电源或燃气管道可能导致电击或爆炸，致人受伤。
- 在地板上方工作时，确保下方无人经过。坠落的部件可能会对旁人造成伤害。
- 如果天气寒冷，或者设备长久未用，重新使用前，要先让设备无负荷运行几分钟。寒冷环境下，高负荷可能会损坏机器。
- 使用工具前，确保凿子固定牢靠。弹出的零件可能会造成伤害。

减少粉尘暴露

开始工作之前，请检查工作时扬尘的危险情况。

-  **警告:**避免接触或吸入粉尘，以免损害身体健康。使用电动工具或进行其他建筑活动时，产生的粉尘可能含有已知会导致使用者或旁观者出现呼吸道感染、过敏反应、癌症、出生缺陷或受到其他生殖性伤害的化学品、矿物或颗粒。
- 例如，在硬木(如山毛榉或橡木)、含铅油漆、混凝土、砖石或含石英的石头上作业时，可能会产生这种粉尘。
- 含有石棉的材料必须由专家处理。
- 请遵守您所在国家对待处理材料的相关规定。
- 请使用符合当地粉尘保护法规，经过官方批准，保护等级达标，且适合于待处理材料的除尘器或抽吸系统。
- 直接在源头捕获产生的粉尘颗粒，避免在周围地区沉积。为此，要使用合适的抽吸附件。

其他措施:

- 确保工作场所的通风良好。
- 佩戴适用于阻隔现场粉尘的呼吸器。

剩余风险

-  **警告:**我们建议使用漏电保护额定电流为30毫安或以下的漏电保护装置。

尽管遵守了相关的安全法规并采用了安全装备，某些剩余风险仍然是无法避免的。这些风险包括:

- 听力损伤。
- 飞溅颗粒造成的人身伤害风险。
- 使用时附件发热导致的灼伤风险。
- 长时间使用引起的人身伤害风险。

请妥善保管好这些说明

电气安全

电机只适用一种工作电压。请务必检查电源电压是否是和铭牌上的电压一致。



DeWALT工具符合IEC62841双重绝缘要求,因此无需使用接地线。

如果电源线损坏,必须仅由DeWALT或授权的维修机构负责更换。

使用延长线

如需延长电缆,请使用经批准适合本工具电源输入的3芯延长电缆(参考**技术数据**)。最小的导线尺寸为1.5mm²;最大长度为30m。

使用电缆卷筒时,请务必拉出所有的电缆。

包装内的物品

包装中包含:

- 1x 凿破机
- 1x 侧手柄
- 1x 凿子
- 1x 工具箱
- 1x 使用手册
- 检查工具、部件或附件是否在运输过程中损坏。
- 操作前,请抽空仔细阅读并掌握本手册。

工具上的标记

工具上印有下列图形:



使用前请阅读使用手册。



请佩戴听力保护器。



请佩戴护目装备。

日期代码位置(图A)

生产日期代码⁹由4位数的年和2位数的周组成,后跟2位数的工厂代码。

描述(图A)



警告:不得改装本电动工具或其任何部件,否则可能会导致损坏或人身伤害。

- 1 通断开关
- 2 主手柄
- 3 凿子位置索引环
- 4 夹头/套筒
- 5 侧手柄
- 6 用于安装手柄的螺钉
- 7 速度控制盘
- 8 工具蓝牙模块安装孔
- 9 日期代码
- 10 黄色服务指示灯LED

设计用途

本重型凿破机专用于破碎或拆除混凝土、砖石、石头和沥青。

请勿在潮湿环境中,或在存在易燃液体或气体的环境中使用本工具。

本重型凿破机是一种专业的电动工具。

请勿让儿童接触本工具。缺乏经验的操作员需要在监督下使用本工具。

- **儿童和体弱者。**在没有他人监督的情况下,儿童或体弱者不适宜使用本产品。
- 本产品不适合体力、感官或智力不足以及缺乏经验、知识或技能的人员(包括儿童)使用,除非一旁有能为他们的安全负责的监督人员。不得在无人监管的情况下让儿童接触本产品。

组装与调整



警告:为降低严重的人身伤害风险,在进行任何调整或取出/安装附件或配件之前,请关闭工具并断开工具与电源的连接。意外启动工具可能会造成伤害。

侧手柄(图B)



警告:为降低人身伤害风险,操作工具时,一定要正确地安装和牢固地侧手柄。如果不这样做,可能会导致在工具操作过程中侧手柄打滑,从而导致失去控制。双手握住工具,以最大限度地稳定控制设备。

侧手柄⁵夹在齿轮箱的前面,可以360度旋转,支持右手或左手使用。

安装侧手柄(图B)

1. 逆时针旋转安装手柄¹¹的螺丝,扩大侧手柄⁵的环形开口⁶。
2. 通过环形开口¹¹将组件滑到工具的前端,并滑到凿子位置索引环³上,经过凿子座和套筒。
3. 将侧手柄旋转到所需位置。
4. 牢牢地拧紧安装手柄⁶的螺丝,将其锁定在适当的位置,顺时针旋转,使组件不会旋转。

凿子和夹头



警告:烧伤危险。更换凿子时一定要戴上手套。操作过程中,工具和凿子上可触及的金属部件可能会变得非常热。小块的破碎材料可能会划伤手部皮肤。

插入和取出SDS max®配件(图C)

本机使用SDS max®凿子(参考图C中的插图,了解SDS max®凿子柄的横截面)。

1. 清洁凿子柄。



警告:请勿在机器上涂抹润滑剂。

2. 拉回锁紧套⁴,插入凿子柄。
3. 松开锁紧套,稍稍转动凿子,直到锁紧套卡住位置。
4. 拉动凿子,检查是否正确锁定。敲击功能要求凿子在锁在凿子座中时,能够在轴向移动几厘米。

- 要想取出凿子，请将锁紧套**4**向后拉，并将凿子从夹头**4**中拉出。

凿子位置的索引(图D)

凿子可以被索引并锁定在12个不同的位置。

- 如上所述，插入凿子。
- 沿着箭头方向旋转凿子位置索引环**3**，直到凿子处于所需位置。

设置电子冲击能量控制盘(图A)



将控制盘**7**转到所需的水平。数字越大，冲击能量就越大。控制盘的可选数值范围为1(低)到7(全功率)，用途非常广泛，可以适应多种应用。

例如，所需的设置是一个经验问题：

- 开凿软、脆的材料，或只允许小幅度破损时，将控制盘设置为1或2(低)；
- 开凿较硬的材料时，将控制盘调到7(全功率)。

服务指示器LED(图A)

- 本工具有黄色的服务指示灯**10**，以提示何时需要服务。有关LED功能的更多信息，请参考下表。

LED功能	说明
 黄色(常亮)	需要服务 黄色服务指示灯 10 亮起，表示工具在接下来的10小时内需要维修(添加润滑油和密封锤子机构)。
 黄色(闪烁)	超出服务范围 在服务指示灯亮起的情况下，再使用10小时后，服务指示灯闪烁，表示工具已经超过了规定的服务间隔时间。

主动振动控制(AVC)系统

为最大限度地控制振动效果，请按照**正确的双手放置位**握住工具，并施加足够的压力，使主手柄上的阻尼装置大约处于中点位置。

主动振动控制能中和锤子机构的回弹振动。这样可降低手和手臂承受的振动，可以长时间舒适地使用设备，并延长设备的寿命。

只要给锤子施加足够的压力，就可以启动主动振动控制装置。压力过多不会使工具开凿或切割的速度更快，主动振动控制也不会启动。

软启动功能

软启动功能能让工具缓慢加速，从而防止钻头在启动时偏离预定孔位。

软启动功能还可以减少在钻头处于现有孔位的情况下，启动锤子时传递给齿轮装置和操作者的即时扭矩反应。

DeWALT工具蓝牙模块准备就绪(图F)

可选配件

本工具带有工具蓝牙模块安装孔**8**和紧固件**12**，可用于安装DeWALT工具蓝牙模块。安装标签时需要T15钻头。

 **警告：**只能使用原装紧固件。长螺丝会增加触电或损坏工具的风险。

DeWALT工具蓝牙模块用于使用DeWALT Tool Connect™应用程序跟踪和定位专业电动工具、设备和机器。DeWALT工具蓝牙模块的正确安装方式请参考DeWALT工具蓝牙模块手册。

吸尘系统(图G)

建议使用除尘系统(DWH051)，以减少潜在的有害粉尘，同时延长工具和配件的使用寿命。

关于适用吸尘系统的更多信息，请咨询您的经销商。

操作

使用说明

 **警告：**务必遵守安全指示和适用法规。

 **警告：**为降低严重的人身伤害风险，在进行任何调整或取出/安装附件或配件之前，请关闭工具并断开工具与电源的连接。意外启动工具可能会造成伤害。

 **警告：**务必遵守安全指示和适用法规。

 **警告：**请注意管道和电线的位置。

 **警告：**对工具施加大约44-66 LBS.(20-30 KG)的压力。压力过大不但不会加快开凿速度，反而会降低工具的性能，并可能缩短工具的使用寿命。

正确的双手放置位(图E1、E2)

 **警告：**为减少重伤的风险，请始终遵循正确的双手放置位，如图所示。

 **警告：**为了减低造成严重人身伤害的风险，预期有突然反作用力时务必握紧。

重要事项：使用工具时，必须始终用两只手握住工具。

水平应用(图E1)

正确的双手放置位要求一只手握住侧手柄**5**，另一只手握住主手柄**2**。

垂直应用(图E2)

正确的双手放置位是双手都放在主手柄**2**上。

开启和关闭(图A)

开启：将开/关**1**调到位置1。

关闭：将开/关**1**调到位置0。

拆除(图A)

 **警告：**确保切削刃不会因压力过大而变色。这可能会削弱配件的硬度。

可用的凿子类型很多。

- 请选择适用的凿子。清洁凿子柄。
- 插入凿子，并检查它是否被正确锁定。
- 设置所需的冲击能量水平。
- 装上并调整侧手柄**5**，并确保它已牢牢拧紧。
- 通过主手柄握住工具，打开开关。工具现在可以持续工作了。

重要事项:操作电锯时,始终用双手操作。请参考**正确的双手放置位**,了解工具在水平和垂直应用中的正确使用方法。

6. 工作结束后,在拔掉插头之前,一定要关闭工具的电源。

维护

您的电动工具设计精良,可以长期使用,仅需极少维护。若要持续令人满意的工作效果,则需对工具进行适当的保养和定期清洁。

警告:为降低严重的人身伤害风险,在进行任何调整或取出/安装附件或配件之前,请关闭工具并断开工具与电源的连接。意外启动工具可能会造成伤害。

润滑

本电动工具无需另行润滑

清洁

警告:电击和机械危险。清洁前,请将电器与电源断开。

警告:为确保操作安全、有效,请注意清洁电器和通风槽。

警告:不得使用溶剂或其它刺激性化学制品来清洁工具的非金属部件。这些化学物质可能会削弱这些部位使用的材料。请用布蘸温和的肥皂水擦拭。不得让任何液体渗入工具,不得让工具的任何部件浸在液体中

通风槽可以用干燥、柔软的非金属刷和/或合适的吸尘器进行清洁。请勿使用水或任何清洁剂。请戴上合格的护目镜和防尘面具。

运输

小心:运输过程中意外启动!

- 运输工具时,一定要卸下电池或断开电源线。
- 在运输后,使用前,请检查工具有无损坏。

存放

- 存放工具前,请从工具上取下电池,或将电源线从电源上断开。
- 存放工具前,请清洁工具。请参考**清洁**。
- 存放场所必须能承受工具的重量。
- 将工具存放在阴凉干燥的地方。
- 将工具存放在儿童或未经授权的人无法接触的地方。
- 使用长期存放的工具前,请检查工具有无损坏。

可选配件

警告:除了DEWALT提供的附件之外,其他附件都未经此产品兼容性测试,若将此类附件与本工具一起使用将存在安全隐患。为降低人身伤害风险,本产品只可使用DEWALT推荐的配件。

请向您的经销商咨询更多关于合适附件的信息。

保护环境

分类回收。由此符号标记的产品不得与普通家庭垃圾一起处理。产品含可恢复或回收的材料,有助于减少原材料的使用量。请根据当地规定回收电子产品。要获得更多信息,请参看www.2helpU.com。

SDS plus®和SDS max®是Robert Bosch GmbH的注册商标。

售后服务和维修

DEWALT维修中心拥有经过培训的人员,能够为顾客提供高效、可靠的产品服务。如果您通过未获授权的维修中心进行维修,我们不会承担任何责任。您可以参见产品包装中的“联系中心定位器”宣传单页,通过热线电话、网站或社交媒体联系我们,找到距离您最近的DEWALT服务中心。

故障排除指南

请务必遵守安全规则和指示

如需产品帮助,请访问我们的网站www.dewalt.com,获取服务中心的清单。

问题	可能的原因	解决方法
工具无法启动。	延长线和/或插头有缺陷。	请具备资质的电工检查延长线和/或插头,必要时予以更换。
	内部部件过热。	让工具冷却下来。
功率下降。	延长线过长和/或规格不合适。	使用长度和/或规格合适的延长线。
	电源的电压不足。	将锤子连接到电压足够的电源上。
凿子无法释放。	夹头没有完全拉回。	将夹头向后拉至最大限度,然后取出凿子。请参考 插入和取出SDS max®配件 。

制 造 商: 百得(苏州)科技有限公司

地 址: 江苏省苏州市工业园区苏虹中路200号出口加工区

产 地: 江苏苏州

产品中有害物质的名称及含量

部件名称 Parts name	有害物质					
	铅 (Pb)	汞 (Hg)	镉 (Cd)	六价铬 (Cr(VI))	多溴联苯 (PBB)	多溴二苯醚 (PBDE)
马达组件	O	O	O	O	O	O
机壳组件	O	O	O	O	O	O
控制部件 (开关, PCB等)	X	O	O	O	O	O
传动部件	X	O	O	O	O	O
电线组件	X	O	O	O	O	O
附件 (钻头/砂轮片等)	O	O	O	O	O	O

本表格依据SJ/T 11364的规定编制。

O: 标识该有害物质在该部位所有均质材料中的含量均在GB/T 26572规定的限量要求以下。

X: 标识该有害物质至少在该部位的某一均质材料中的含量超出GB/T 26572规定的限量要求

备注: 本产品不必包含以上所述的所有部件。由于生产工艺和技术的不可替代性, 本产品中含有某些有害物质, 在环保使用期限内可以放心使用, 超过环保使用期限之后则应进入回收循环系统。

环保使用期限为“电子电气产品中含有的有害物质不会发生外泄或突变, 电子电气产品用户正常使用该电子电气产品不会对环境造成严重污染或对其人身、财产造成严重损害的期限”。



环保使用期限为20年。此环保使用期限不代表产品的安全使用期限和质量保证年限。