

 **BLACK &  
DECKER®**



**GL420**

**GL423**

**GL425**

**GL430**



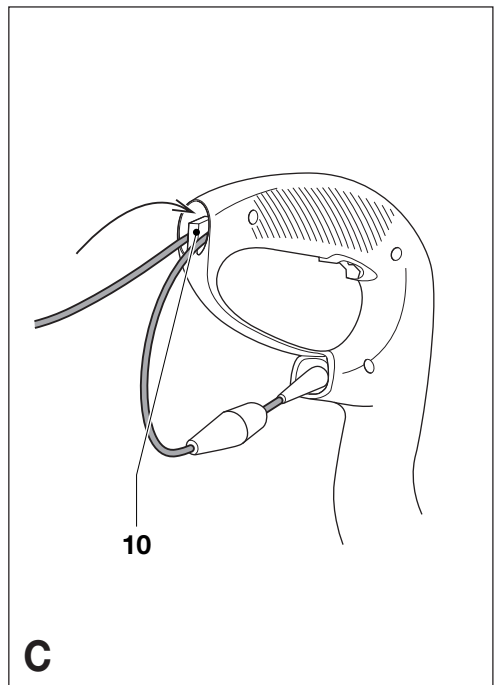
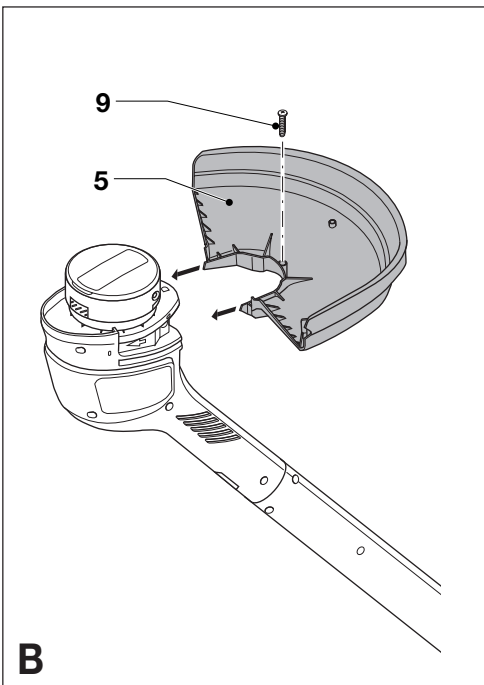
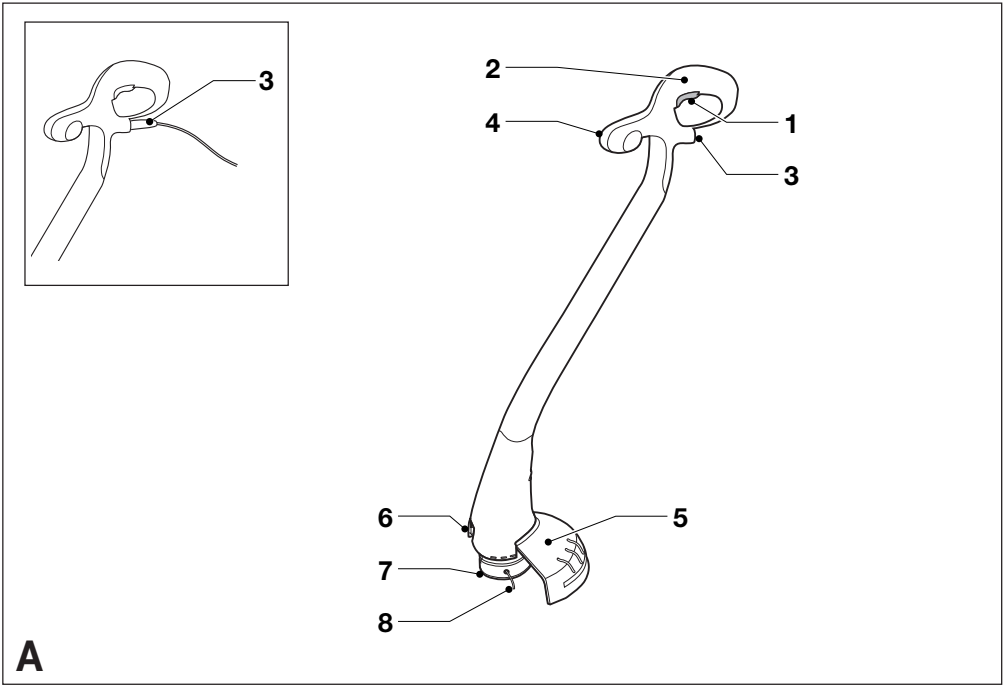

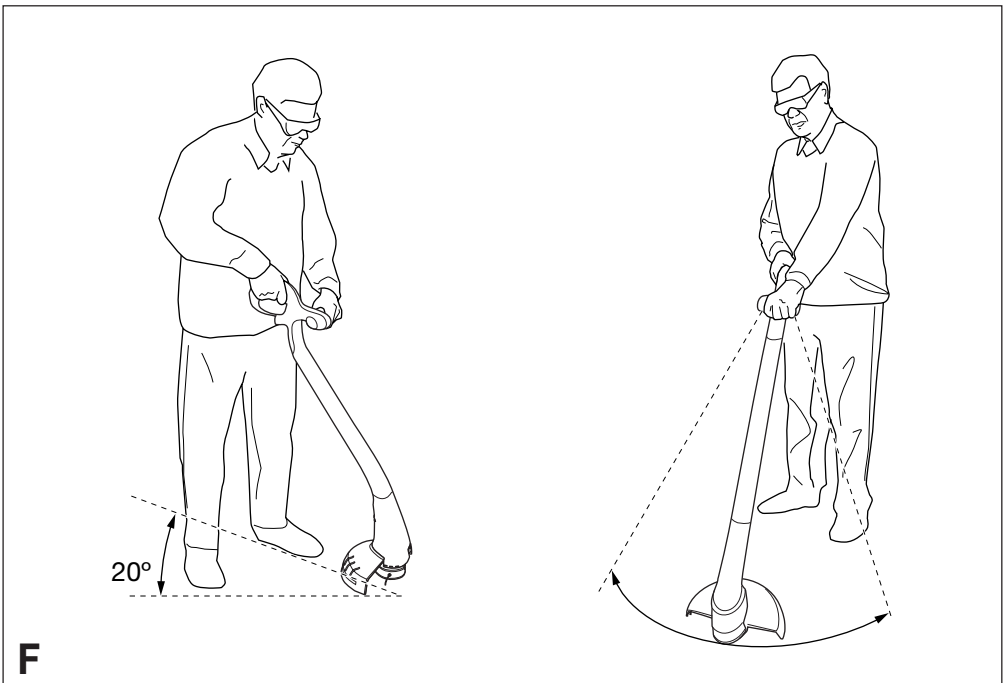
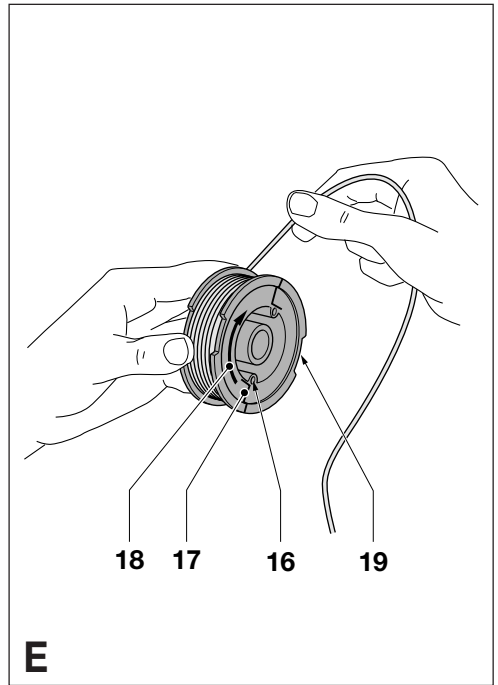
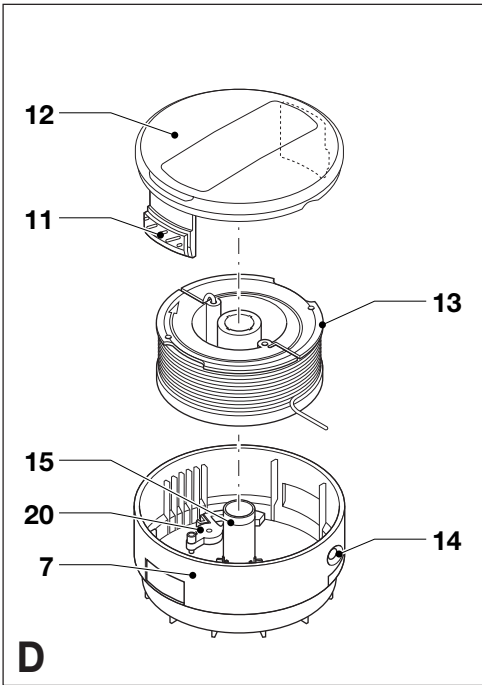

# STRIMMER GL420/GL423/GL425/GL430

## CONGRATULATIONS!

You have chosen a Black & Decker tool. Our aim is to provide quality tools at an affordable price. We hope that you will enjoy using this tool for many years

## EC DECLARATION OF CONFORMITY

**CE** GL420/GL423/GL425/GL430 families  
Black & Decker declares that these products conform to: 98/37/EC, 89/336/EEC, 73/23/EEC, EN 60335, EN 55014, EN 61000, 2000/14/EC, Lawn trimmer, L ≤ 50 cm

Annex VIII, No. 0086,  
B.S.I., HP2 4SQ, United Kingdom

Level of sound pressure, measured according to 2000/14/EC:

$L_{pA}$	(sound pressure)	dB(A)	81
$L_{WA}$	(acoustic power)	dB(A)	94
$L_{WA}$	(guaranteed)	dB(A)	96

 Always wear ear protection if the sound pressure exceeds 85 dB(A).

Hand/arm weighted vibration value according to 98/37/EC:

< 2.5 m/s<sup>2</sup>



Brian Cooke  
Director of Engineering  
Spennymoor, County Durham DL16 6JG,  
United Kingdom  
1-12-2001

## INTENDED USE

Your Black & Decker strimmer GL420/GL423/GL425/GL430 families has been designed for trimming lawn edges and to cut grass in confined spaces. This tool is intended for consumer use only.

## SAFETY INSTRUCTIONS

### Warning symbols

The following symbols are used in this manual:



Denotes risk of personal injury, loss of life or damage to the tool in case of non-observance of the instructions in this manual.



Denotes risk of electric shock.



Read the manual prior to operation.

### Know your appliance



- ◆ **Warning!** When using mains-powered appliances, basic safety precautions, including the following, should always be followed to reduce the risk of fire, electric shock and personal injury.
- ◆ Read all of this manual carefully before operating the appliance.
- ◆ Before operating the appliance, make sure that you know how to switch it off in an emergency.
- ◆ The intended use is described in this manual. The use of any accessory or attachment or performance of any operation with this appliance other than those recommended in this instruction manual may present a risk of personal injury.
- ◆ Retain this manual for future reference.

## Work area

- ◆ Do not expose the appliance to rain. Do not use the appliance in damp or wet conditions.
- ◆ Only use the appliance in daylight or good artificial light.

## Personal protection

- ◆ Wear stout shoes or boots to protect your feet. Do not operate the appliance wearing open-toed sandals or when barefoot.
- ◆ Wear long trousers to protect your legs.

## Using your appliance

- ◆ Be sure that the appliance is switched off when plugging in.
- ◆ Stay alert. Watch what you are doing. Use common sense.
- ◆ Do not operate the appliance when you are tired.
- ◆ If the appliance begins to vibrate abnormally, switch it off and remove the plug from the socket. Allow rotating parts to stop and inspect the appliance for damage and loose parts.
- ◆ Never pull the cord to disconnect the plug from the socket. Keep the cord away from heat, oil and sharp edges.
- ◆ If the mains cable is damaged during use, switch the appliance off and disconnect the plug from the mains immediately. **Do not touch the mains cable before disconnecting from the mains.**

## Safety of others

- ◆ Do not allow children or any person unfamiliar with these instructions to operate the appliance.
- ◆ Do not allow children, visitors or animals to come near the work area or to touch the appliance or mains cable.
- ◆ Remember that the operator may be held responsible for accidents or hazards occurring to other people or their property.

## After use

- ◆ Switch off, remove the plug from the socket and ensure that moving parts have stopped rotating before leaving the appliance unattended and before changing, cleaning or inspecting any parts of the appliance.

- ◆ When not in use, the appliance should be stored in a dry place. Children should not have access to stored appliances.

## Inspection and repairs

- ◆ Before use, check the appliance for damaged or defective parts. Check for misalignment and seizure of moving parts, breakage of parts, damage to guards and switches and any other conditions that may affect its operation.
- ◆ Do not use the appliance if any part is damaged or defective. Do not use the appliance if the switch does not turn it on and off.
- ◆ Never use the appliance when any guard or enclosure is damaged or not in place.
- ◆ Ensure that the appliance will operate properly and perform its intended function.
- ◆ Have any damaged or defective parts repaired or replaced by an authorised repair agent.
- ◆ Before use, check the mains cable for signs of damage, ageing and wear.
- ◆ Do not use the appliance if the mains cable is damaged or defective.
- ◆ If the mains cable is damaged or defective it must be repaired by an authorised repair agent to avoid a hazard.
- ◆ Never attempt to remove or replace any parts other than those specified in this manual.

## Additional safety instructions for grass trimmers

The following warning symbols are found on the appliance:

Wear safety glasses or goggles when operating this tool.



The cutting line will continue to run for a few seconds after switching the appliance off. Never attempt to force the line to come to a standstill.



Keep people and animals at least 6 m away from the cutting area.



Do not expose the appliance to rain or high humidity.



Switch off, remove the plug from the socket and ensure that moving parts have stopped rotating before leaving the appliance unattended and before changing, cleaning or inspecting any parts of the appliance.

- ◆ Before using the appliance, check that your cutting path is free from sticks, stones, wire and any other objects.
- ◆ Only use the appliance in the correct position, with the cutting line near the ground, as shown in the illustrations. Never switch the appliance on in any other position.
- ◆ Switch on the appliance only when hands and feet are away from the cutting line.
- ◆ Avoid body contact with the cutting line while the appliance is running.
- ◆ Do not work on steep slopes. Be sure of your footing. Be aware that freshly cut grass is damp and slippery.
- ◆ Take care when trimming near borders and gravel paths or roads, as stones and soil may be moved by the cutting line.
- ◆ Do not put the appliance down until the cutting line has come to a complete standstill.
- ◆ Use only the appropriate type of Black & Decker cutting line. Never use metal cutting line or fishing line.
- ◆ Take care to avoid injury from the line trimming blade. Do not touch the blade. After extending new cutting line, always return the appliance to its normal operating position before switching on.
- ◆ Take care to keep the mains cable away from the cutting line. Always be aware of the position of the cable.

### ELECTRICAL SAFETY

The appliance has been designed for one voltage only. Always check that the power supply corresponds to the voltage on the rating plate.



This appliance is designed for use on AC (mains) power supplies only. Do not attempt to use on any other supply.



This appliance is double insulated in accordance with EN 60335; therefore no earth wire is required.

- ◆ Prevent body contact with earthed or grounded surfaces (e.g. metal railings, lamp-posts etc.).
- ◆ Electric safety can be further improved by using a high-sensitivity (30 mA/30 mS) residual current device (RCD).

### Mains plug replacement (U.K. & Ireland only)

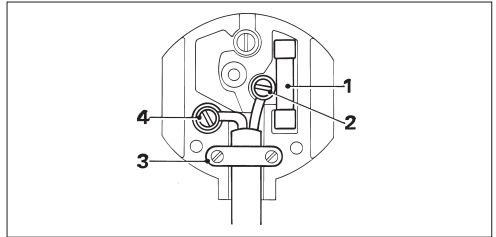

- ◆ Should your mains plug need replacing and you are competent to do this, proceed as instructed below. If you are in doubt, contact an authorised repair agent or a qualified electrician.
- ◆ Disconnect the plug from the supply and remove the fuse from the plug.
- ◆ Cut off the plug and dispose of it safely; a plug with bared copper conductors is dangerous if engaged in a live socket outlet.
- ◆ Only fit 13 Amperes BS1363A approved plugs fitted with the correctly rated fuse (1). Use 5 Amperes fuses.
- ◆ The cable wire colours, or a letter, will be marked at the connection points of most good quality plugs. Attach the wires to their respective points in the plug (see above). Brown is for Live (L) (2), blue is for Neutral (N) (4).
- ◆ Before replacing the top cover of the mains plug ensure that the cable restraint (3) is holding the outer sheath of the cable firmly and that the leads are correctly fixed at the terminal screws.
- ◆ If the plug has a fuse cover, make sure that the fuse cover is fitted. Do not use the plug if the fuse cover is missing or damaged.



Never use a light socket.



Never use the tool unless the guard is properly fitted.

## Using an extension cable

Always use an approved extension cable suitable for the power input of this appliance (see rating plate). The extension cable must be suitable for outdoor use.

- ◆ Before use, inspect the cable for signs of damage, wear and ageing. Replace the extension cable if damaged or defective.
- ◆ When using a cable reel, always unwind the cable completely.
- ◆ Take care to keep the cable away from the cutting line. Always be aware of the position of the cable.

## CARTON CONTENTS

The carton contains:

- 1 Grass trimmer
- 1 Guard with mounting screw
- 1 Instruction manual

- ◆ Carefully unpack all parts.

## OVERVIEW (fig. A)

1. On/off switch
2. Handle
3. Power inlet (not for UK)
3. Mains cable (UK)
4. Secondary handle (GL430)
5. Guard
6. Line trimming blade
7. Spool housing
8. Cutting line

## ASSEMBLY



Before assembly, make sure that the tool is switched off and unplugged.

## Fitting the guard (fig. B)

- ◆ Unplug the tool.
- ◆ Remove the screw (9) from the guard (5).
- ◆ Place the guard (5) onto the tool as shown.
- ◆ Firmly press the guard until it snaps into place.
- ◆ Secure the guard with the screw (9).

## Releasing the cutting line (fig. A)

In transit, the cutting line is taped to the spool housing.

- ◆ Remove the tape holding the cutting line (8) to the spool housing (7).

## Connecting the tool to the mains (fig. A & C)

Unless the tool is fitted with a mains cable, you will need to connect an extension cable to the power inlet (3).

- ◆ Connect the female socket of a suitable extension cable to the power inlet (3).
- ◆ Loop the cable through the cable restraint (10) as shown to prevent the extension cable from becoming detached during use.
- ◆ Insert the mains plug into a mains outlet.



The extension cable must be suitable for outdoor use.

## USE



Let the tool work at its own pace. Do not overload.

## Switching on and off (fig. A)

- ◆ To switch the tool on, push the on/off switch (1).
- ◆ To switch the tool off, release the the on/off switch.



Never attempt to lock a switch in the on position.

## Automatic line feed

The Reflex system will automatically feed out more cutting line when necessary.

## Hints for optimum use

- ◆ Hold the tool as shown in fig. F.
- ◆ Gently swing the trimmer from side to side as shown in fig. F.
- ◆ When cutting long grass, work in stages from the top.
- ◆ Keep the tool away from hard objects and delicate plants.



- ◆ If the tool starts running slowly, reduce the load.
- ◆ In order to achieve optimum cutting results, only cut dry grass.

## MAINTENANCE

Your Black & Decker tool has been designed to operate over a long period of time with a minimum of maintenance. Continuous satisfactory operation depends upon proper tool care and regular cleaning.



Before performing any maintenance, switch off and unplug the tool.

- ◆ Regularly clean the ventilation slots in your tool using a soft brush or dry cloth.
- ◆ Regularly clean the cutting line and spool using a soft brush or dry cloth.
- ◆ Regularly use a blunt scraper to remove grass and dirt from the underneath of the guard.



Do not use any abrasive or solvent-based cleaner.

### Fitting a new spool of cutting line (fig. D)

Replacement spools of cutting line are available from your Black & Decker dealer (cat. no. A6481).

- ◆ Unplug the tool.
- ◆ Keep the tabs (11) depressed and remove the spool cover (12) from the housing (7).
- ◆ Remove the empty spool (13) from the housing.
- ◆ Remove any dirt and grass from the housing.
- ◆ Take the new spool and unwind approx. 9 cm of cutting line.
- ◆ Feed the cutting line through the eyelet (14).
- ◆ Push the spool onto the drive shaft (15) and rotate it slightly until it is seated. Make sure that the cutting line is not trapped under the spool and that 9 cm of cutting line protrudes from the housing.
- ◆ Align the tabs on the spool cover with the holes in the housing.
- ◆ Push the cover onto the housing until it snaps securely into place.



If the cutting line protrudes beyond the trimming blade (6), cut it off so that it just reaches the blade.

### Winding new line onto an empty spool (fig. E)

You may wind new cutting line onto an empty spool. Replacement packs of cutting line are available from your Black & Decker dealer (cat. no. A6170 (25 m), A6171 (40 m)).

- ◆ Remove the empty spool from the tool as described above.
- ◆ Remove any old cutting line from the spool.
- ◆ Feed 2 cm of cutting line into one of the holes (16) in the spool as shown.
- ◆ Bend the cutting line and anchor it in the L-shaped slot (17).
- ◆ Wind the cutting line onto the spool in the direction of the arrow (18). Make sure to wind the line on neatly and in layers. Do not criss-cross.
- ◆ When the wound cutting line reaches the recesses (19), cut the line. Let the line protrude approx. 9 cm from the spool and hold a finger on the line to keep it in place.
- ◆ Proceed as described above to fit the spool on the tool.



Only use round 1.5 mm diameter Black & Decker cutting line. Do not use Reflex Plus twisted cutting line. The use of an incorrect type of cutting line can damage the auto feed mechanism and will void the warranty.

## TROUBLESHOOTING

If your tool seems not to operate properly, follow the instructions below. If this does not solve the problem, please contact your local Black & Decker repair agent.



Before proceeding, unplug the tool.

### Tool does not start

- ◆ Check that the power cables are properly connected.
- ◆ Check the mains fuses.

### Tool vibrates strongly

- ◆ Carefully clean the spool housing.
- ◆ If this does not solve the problem, unwind the line from the spool and rewind it more tightly.

## **Tool runs slowly**

- ◆ Check that the spool housing can rotate freely. Carefully clean it if necessary.
- ◆ Check that the cutting line does not protrude more than 9 cm from the spool housing. If it does, cut it off so that it just reaches the line trimming blade.

## **Automatic line feed does not work**

- ◆ Keep the tabs depressed and remove the spool cover from the housing.
- ◆ Lift the spool approx. 6 mm and pull the cutting line until it protrudes 9 cm from the housing. If insufficient cutting line is left on the spool, install a new spool of cutting line as instructed above.
- ◆ Push the spool back into place and rotate it slightly until it is seated.
- ◆ Align the tabs on the spool cover with the holes in the housing.
- ◆ Push the cover onto the housing until it snaps securely into place.
- ◆ If the cutting line protrudes beyond the trimming blade, cut it off so that it just reaches the blade.

If the automatic line feed still does not work or the spool is jammed, try the following suggestions:

- ◆ Carefully clean the spool cover and housing.
- ◆ Remove the spool and check if the lever (20) can move freely (fig. D).
- ◆ Remove the spool and unwind the cutting line, then wind it on neatly again as described above. Replace the spool as instructed.

## **PROTECTING THE ENVIRONMENT**



Black & Decker provides a facility for recycling Black & Decker products once they have reached the end of their working life. This service is provided free of charge. To take advantage of this service please return your product to any authorised repair agent who will collect them on our behalf.

You can check the location of your nearest authorised repair agent by contacting your local Black & Decker office at the address indicated in this manual. Alternatively, a list of authorised Black & Decker repair agents and full details of our after-sales service and contacts are available on the Internet at: **[www.2helpU.com](http://www.2helpU.com)**.

## **GUARANTEE**

Black & Decker is confident of the quality of its products and offers an outstanding guarantee. This guarantee statement is in addition to and in no way prejudices your statutory rights. The guarantee is valid within the territories of the Member States of the European Union and the European Free Trade Area.

If a Black & Decker product becomes defective due to faulty materials, workmanship or lack of conformity, within 24 months from the date of purchase, Black & Decker guarantees to replace defective parts, repair products subjected to fair wear and tear or replace such products to ensure minimum inconvenience to the customer unless:

- ◆ The product has been used for trade, professional or hire purposes;
- ◆ The product has been subjected to misuse or neglect;
- ◆ The product has sustained damage through foreign objects, substances or accidents;
- ◆ Repairs have been attempted by other persons than authorised repair agents or Black & Decker service staff.

To claim on the guarantee, you will need to submit proof of purchase to the seller or an authorised repair agent. You can check the location of your nearest authorised repair agent by contacting your local Black & Decker office at the address indicated in this manual. Alternatively, a list of authorised Black & Decker repair agents and full details of our after-sales service and contacts are available on the Internet at: **[www.2helpU.com](http://www.2helpU.com)**.

**OTHER OUTDOOR TOOLS**

Black & Decker has a full range of outdoor power tools that make life in the garden easy. If you would like further information on the following products, please contact our Service and Information Centre (see the address page towards the end of this manual) or your local Black & Decker retailer.

String trimmers	Chainsaws
Cordless shear	Hedgetrimmers
Lawnmowers	Lawnrakers
Leafbusters	Shredders

Not all products are available in all countries.

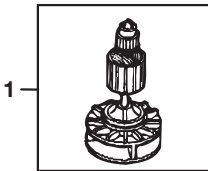
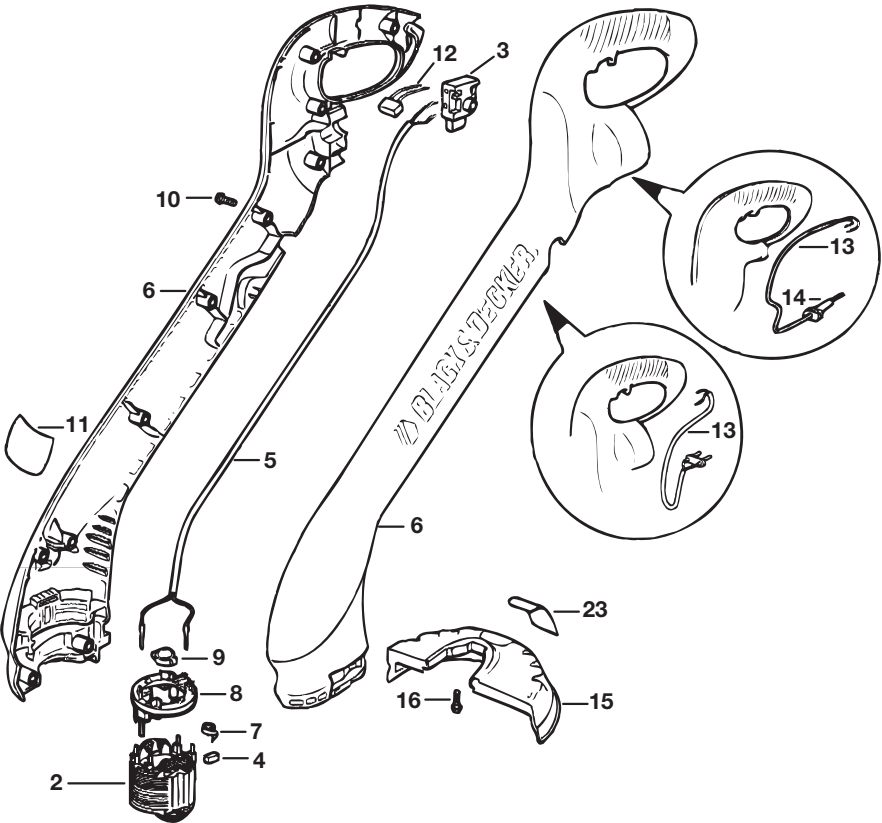

GL20S GL20SC

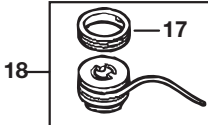
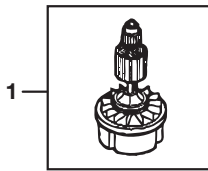

GL225/225S/225SC/225C

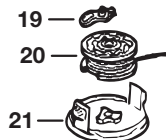
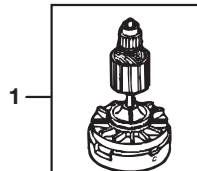

GL420/GL423/GL425/425S/425SC

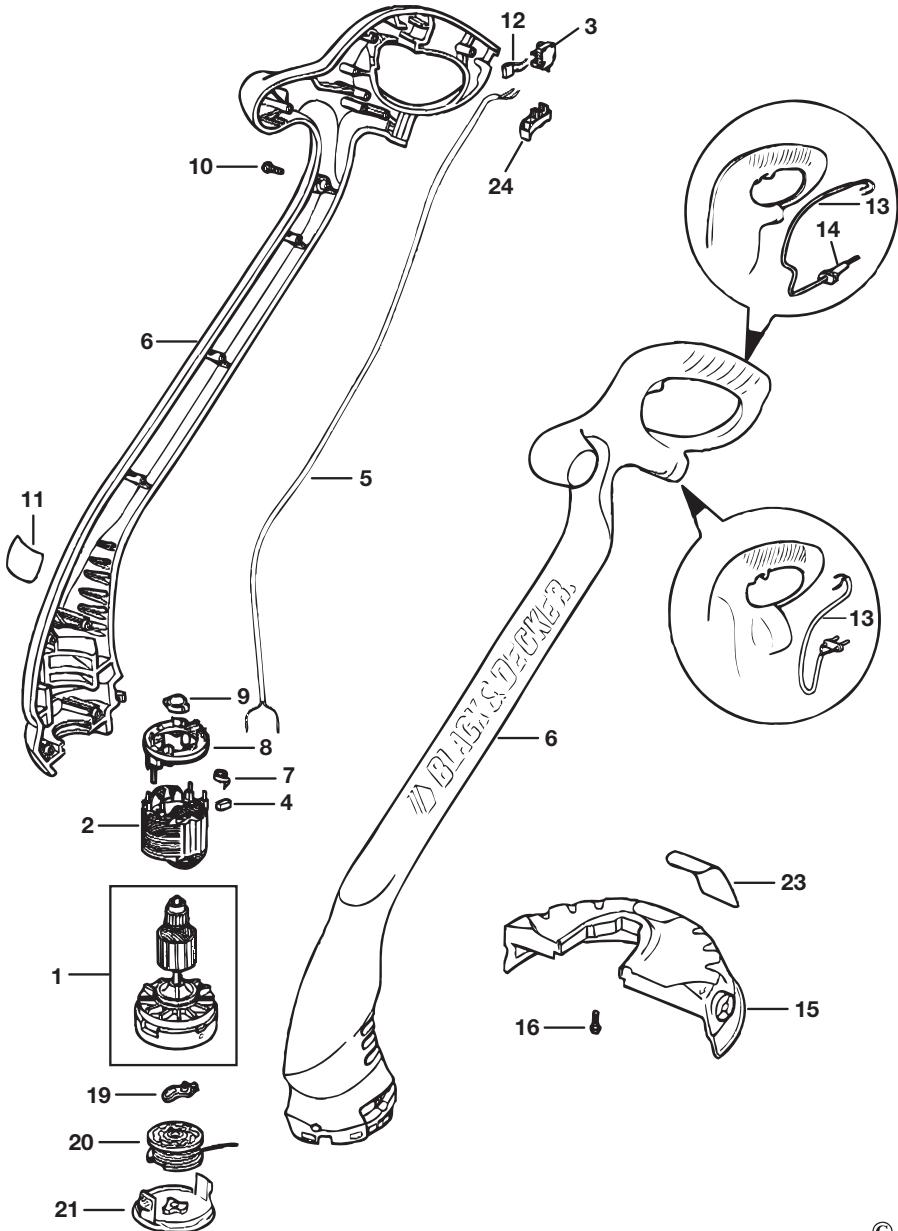





**Australia**

DeWALT Industrial Power Tool Company  
7 Clarice Road  
Box Hill, Victoria 3128

Tel. 03 9895 9200  
Fax 03 9899 7465

---

**New Zealand**

Black & Decker  
81 Hugo Johnston Drive  
Penrose, Auckland, New Zealand

Tel. 09 579 7600  
Fax 09 579 8200

---

**United Kingdom**

Black & Decker  
210 Bath Road  
Slough, Berkshire SL1 3YD

Tel. 01753 511234  
Fax 01753 551155  
Helpline 01753 574277

---