

# BLACK+ DECKER

[www.blackanddecker.com](http://www.blackanddecker.com)

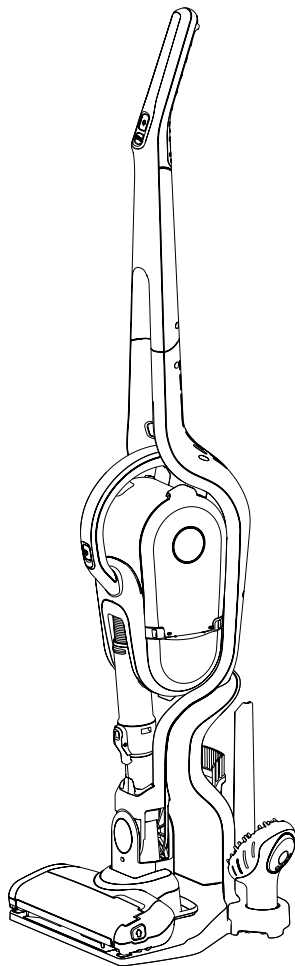

SVFV3250L  
SVFV3250LR

English  
简体中文

12  
18

# Assembly

## 组装

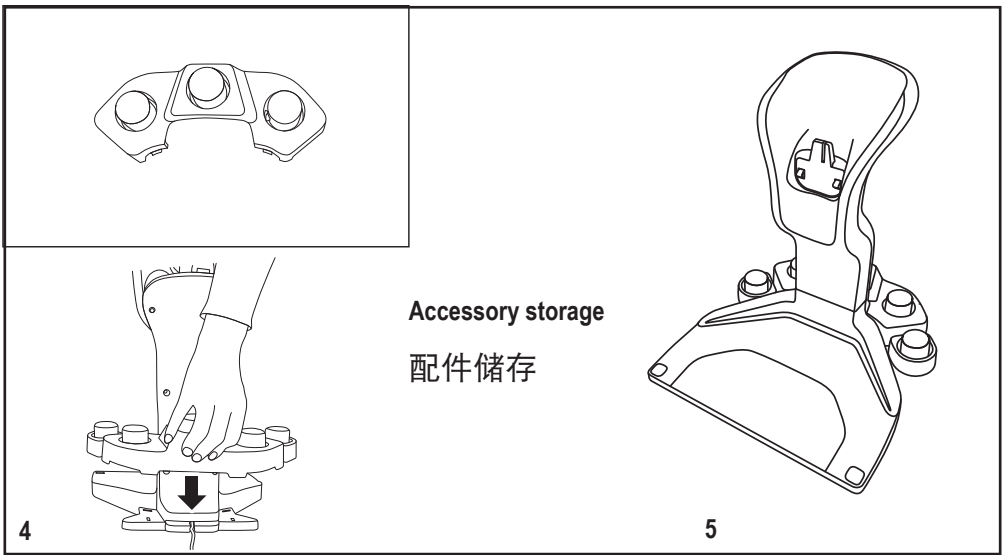
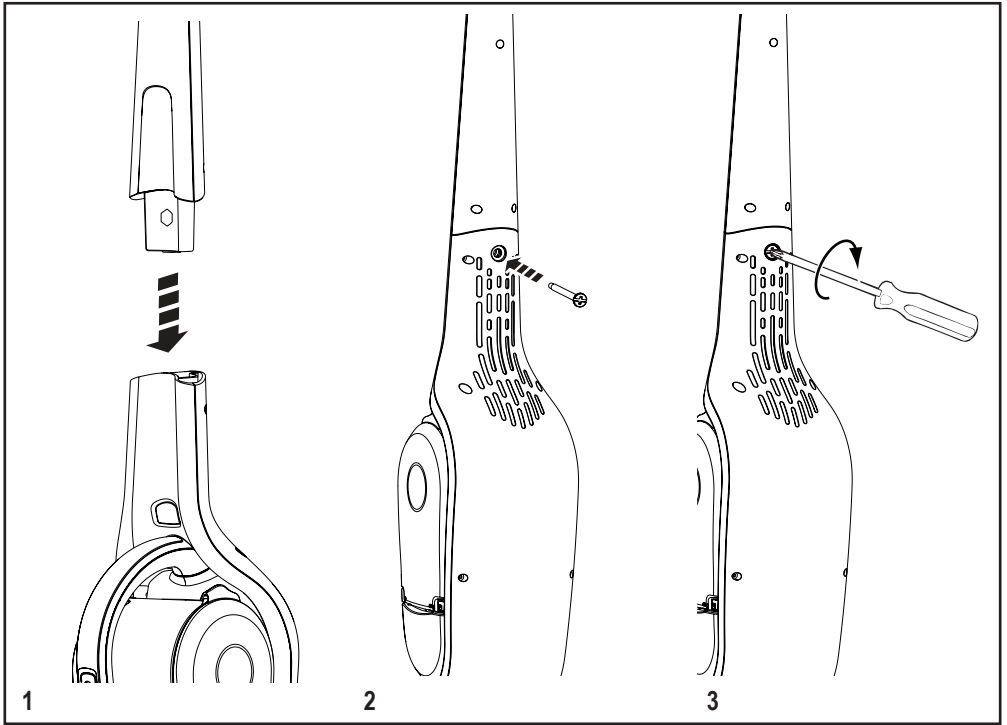

## Charging 充电

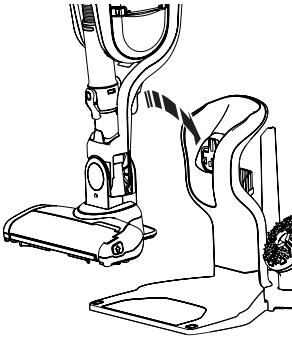

1

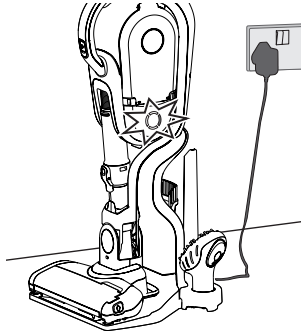

2

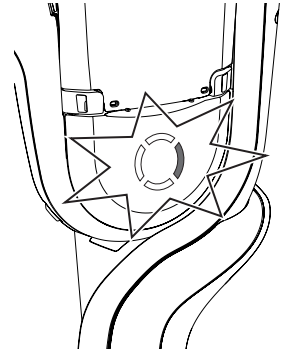

3

## LED patterns LED 模式

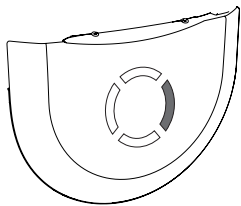

0 - 25%

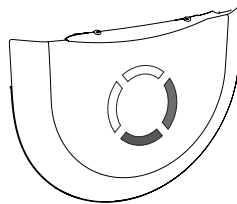

25 - 50%

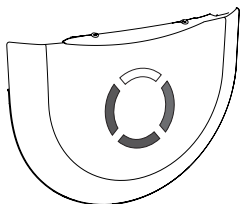

50 - 75%

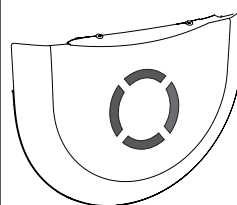

75 - 100%

## LED patterns

### LED 模式



The light will go out when charging is complete.

充电结束时指示灯将会熄灭。



The appliance can be left connected to the charger and may become warm during use.

设备可以一直与充电器保持连接，并可能在使用期间发热。

## Use 使用

Vacuum On / Off

真空吸尘器开/关

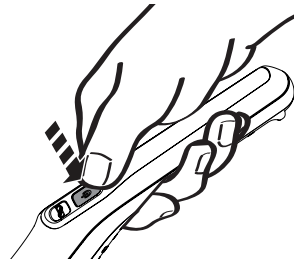

Powered brush On / Off

电动刷开/关

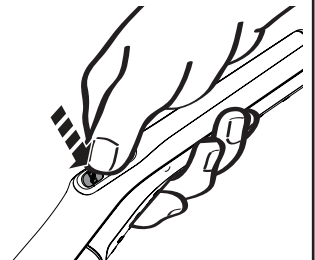

## LED patterns LED 模式



For battery charge, level, LED's illuminate the same as when charging

LED 指示灯模式将显示电池的充电电量，请参阅“充电时指示灯模式”图



Battery low  
电池电量低



Battery empty  
电池电量用尽

## Remove hand vaccum 拆卸手持式真空吸尘器

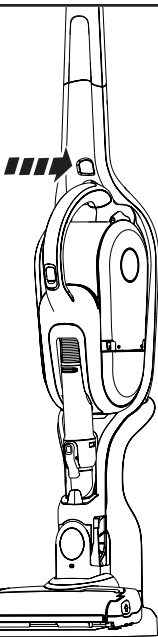

1

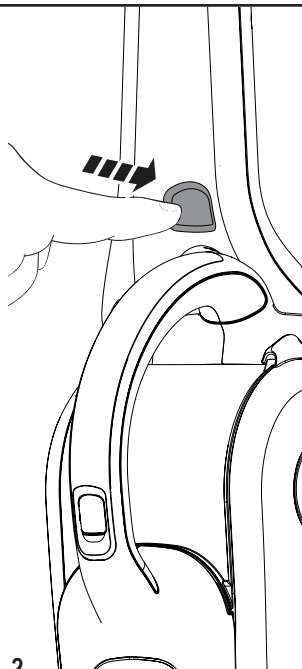

2

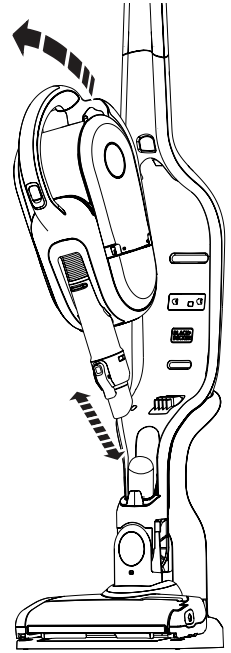

3

On / Off

开/关

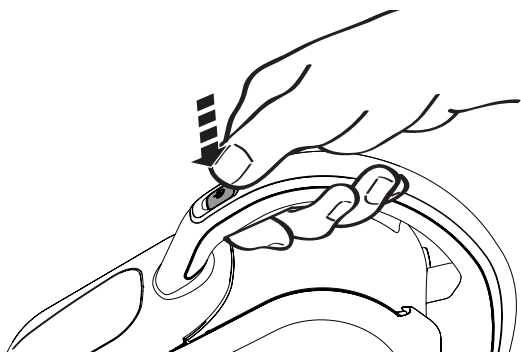

Flexible nozzle

活动吸嘴

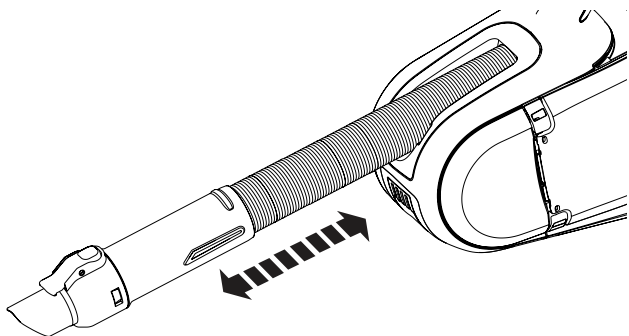

## Accessories

附件

Fitting accessories

安装配件

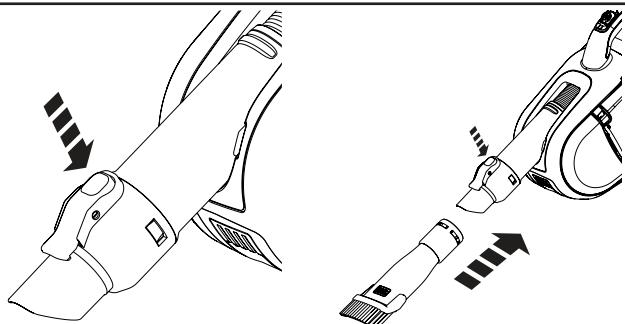

## Emptying 清空

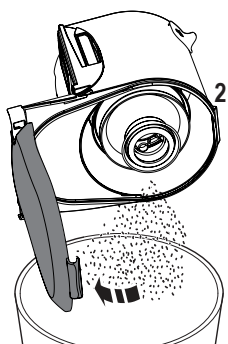
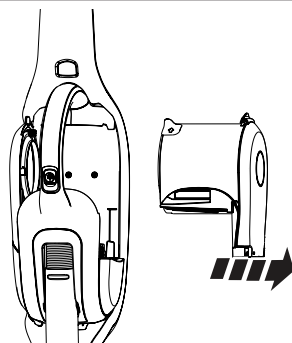
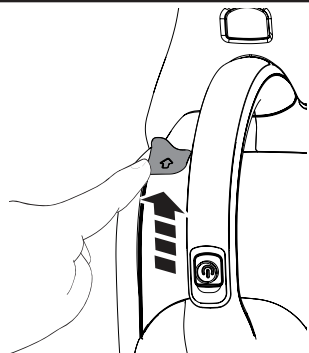
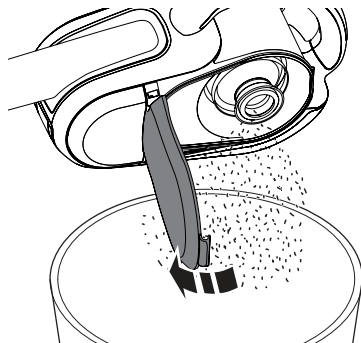
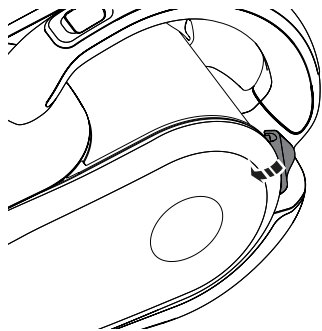

Tap to empty  
轻拍以清空

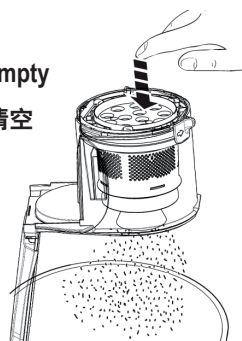

In order to keep the suction force optimised, the filters must be cleared regularly during use.

为了达到最佳吸尘力，使用过程中必须定期清洁过滤器。

Clean cyclonic filter

清洁气旋过滤器

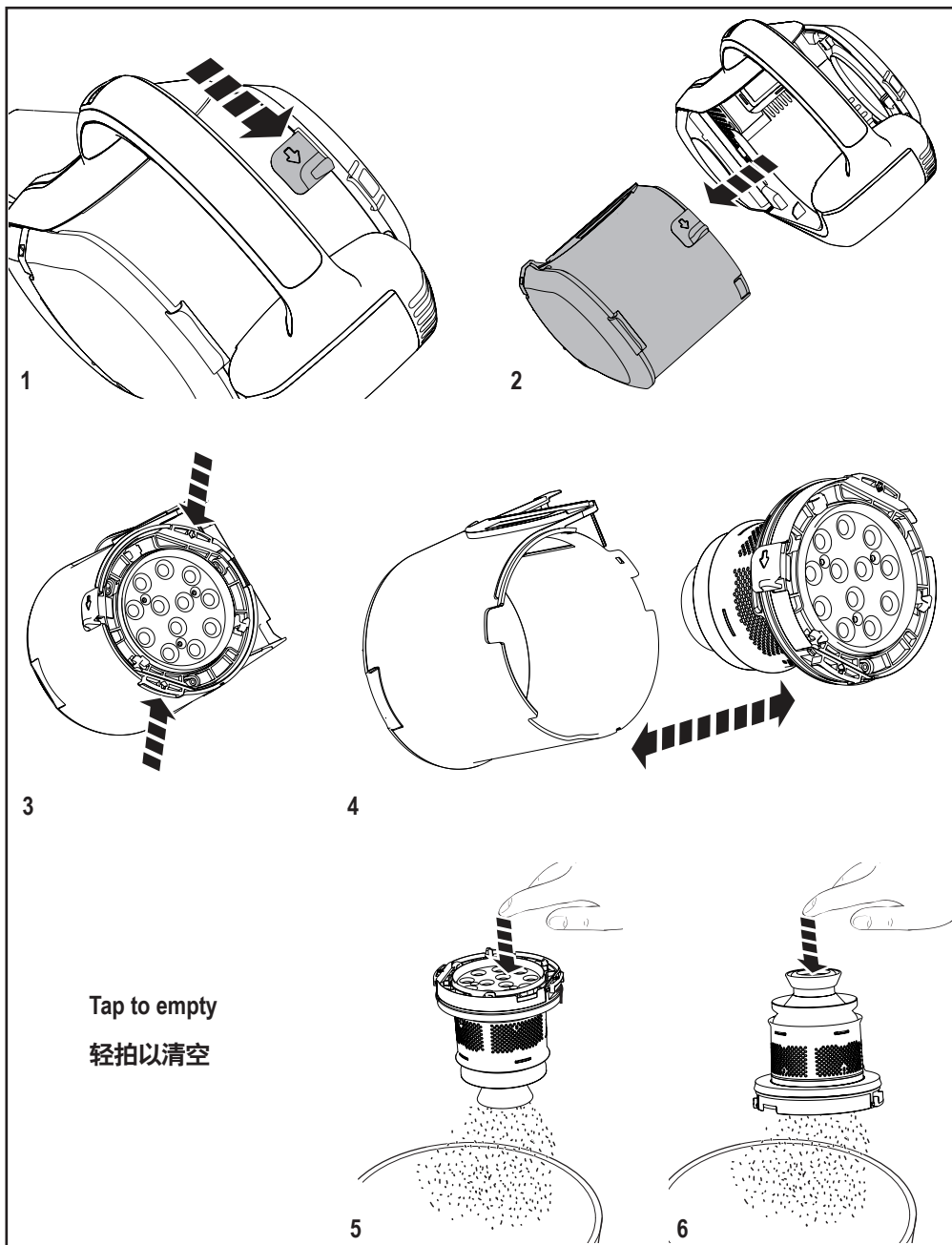



Re-assemble after cleaning the filter or continue to wash.

在清洗过滤器后重新装配或继续冲洗。

## Wash 冲洗

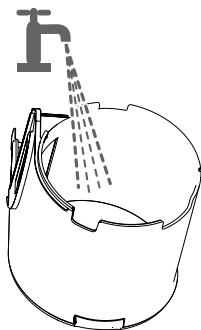
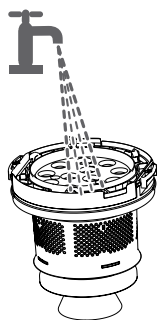

Dry thoroughly  
彻底干燥

## Clean floor head 清洁地板头

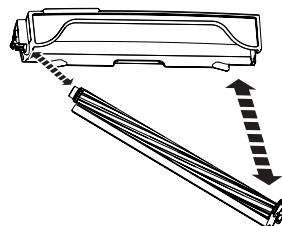
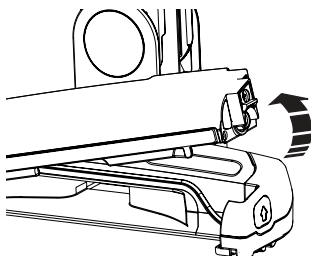
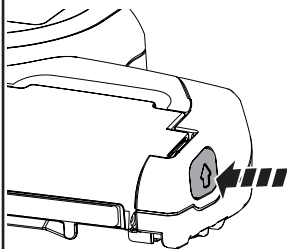

Clean exhaust filter  
清洁排尘过滤器

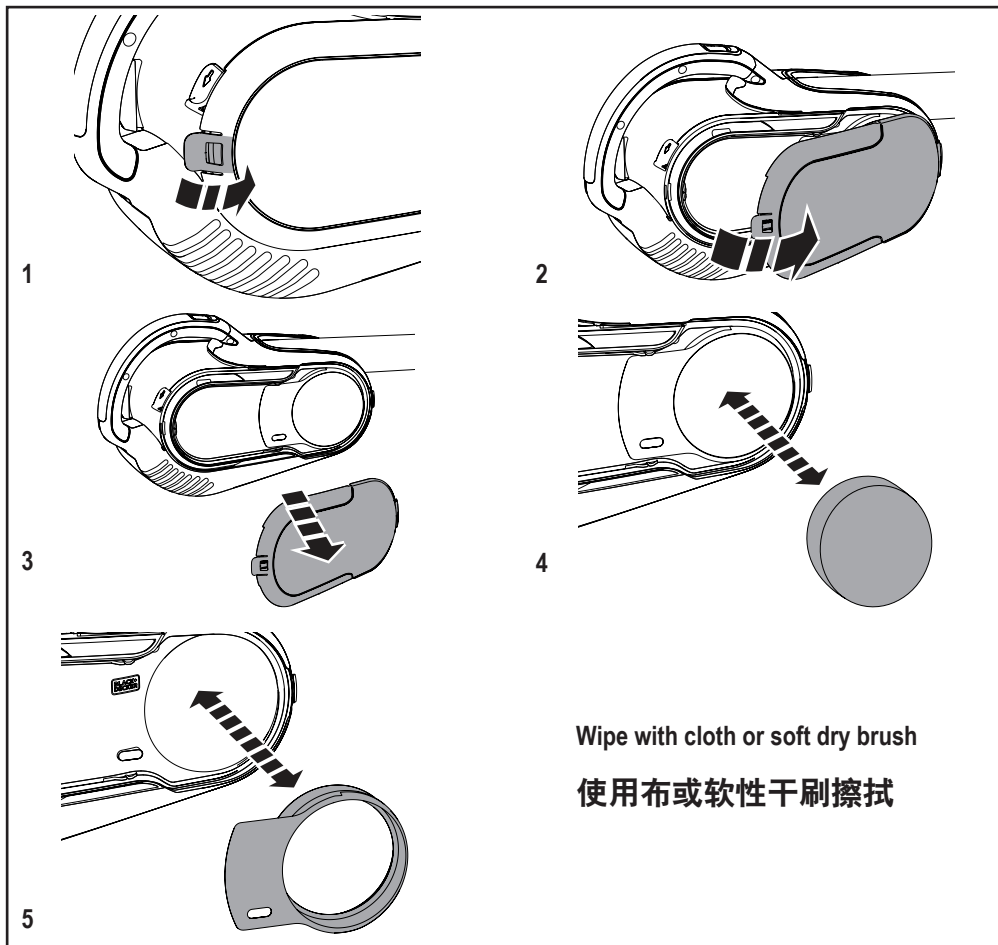

Wipe with cloth or soft dry brush  
使用布或软性干刷擦拭

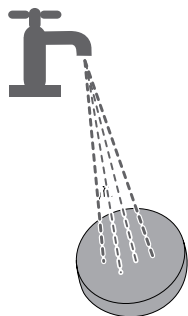

Dry thoroughly  
彻底擦干

# Features

## 功能部件

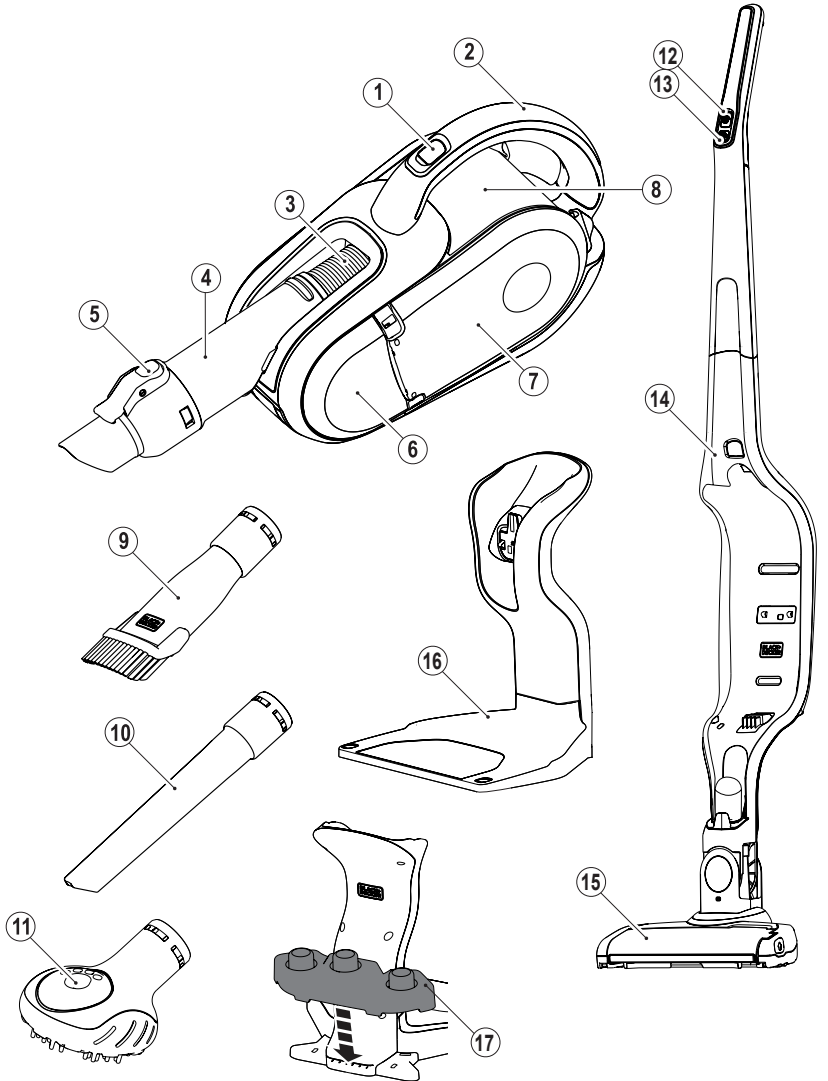

**Intended use**

Your Black & Decker Dustbuster® handheld vacuum cleaner has been designed for vacuum cleaning purposes. This appliance is intended for household use only.



Read all of this manual carefully before operating the appliance.

**Safety instructions**

**Warning! Read all safety warnings and all instructions.** Failure to follow the warnings and instructions listed below may result in electric shock, fire and/or serious injury.



**Warning!** When using battery-powered appliances, basic safety precautions, including the following, should always be followed to reduce the risk of fire, leaking batteries, personal injury and material damage.

- ◆ Read all of this manual carefully before using the appliance.
- ◆ The intended use is described in this manual. The use of any accessory or attachment or the performance of any operation with this appliance other than those recommended in this instruction manual may present a risk of personal injury.
- ◆ Retain this manual for future reference.

**Using your appliance**

- ◆ Do not use the appliance to pick up liquids or any materials that could catch fire.

- ◆ Do not use the appliance near water.
- ◆ Do not immerse the appliance in water.
- ◆ Never pull the charger lead to disconnect the charger from the socket. Keep the charger lead away from heat, oil and sharp edges.
- ◆ This appliance is not intended for use by persons (including children) with reduced physical, sensory or mental capabilities, or lack of experience and knowledge, unless they have been given supervision or instruction concerning use of the appliance by a person responsible for their safety. Children shall not play with the appliance. Cleaning and user maintenance shall not be made by children without supervision.

**Inspection and repairs**

- ◆ Before use, check the appliance for damaged or defective parts. Check for breakage of parts, damage to switches and any other conditions that may affect its operation.
- ◆ Do not use the appliance if any part is damaged or defective.
- ◆ Have any damaged or defective parts repaired or replaced by an authorized repair agent.
- ◆ Regularly check the charger lead for damage. Replace the charger if the lead is damaged or defective.
- ◆ Never attempt to remove or replace any parts other than those specified in this manual.

## Additional safety instructions

### After use

- ◆ Unplug the charger before cleaning the charger or charging base.
- ◆ When not in use, the appliance should be stored in a dry place.
- ◆ Children should not have access to stored appliances.

### Residual risks.

Additional residual risks may arise when using the tool which may not be included in the enclosed safety warnings. These risks can arise from misuse, prolonged use etc.

Even with the application of the relevant safety regulations and the implementation of safety devices, certain residual risks can not be avoided. These include:

- ◆ Injuries caused by touching any rotating/moving parts.
- ◆ Injuries caused when changing any parts, blades or accessories.
- ◆ Injuries caused by prolonged use of a tool. When using any tool for prolonged periods ensure you take regular breaks.
- ◆ Impairment of hearing.
- ◆ Health hazards caused by breathing dust developed when using your tool (example:- working with wood, especially oak, beech and MDF.)

## Batteries and chargers

### Batteries

- ◆ Never attempt to open for any reason.
- ◆ Do not expose the battery to water.
- ◆ Do not expose the battery to heat.
- ◆ Do not store in locations where the temperature may exceed 40°C.
- ◆ Charge only at ambient temperatures between 10°C and 40°C.
- ◆ Charge only using the charger provided with the appliance. Using the wrong charger could result in an electric shock or overheating of the battery.
- ◆ When disposing of batteries, follow the instructions given in the section "Protecting the environment".
- ◆ Do not damage/deform the battery pack either by puncture or impact, as this may create a risk of injury and fire.
- ◆ Do not charge damaged batteries.
- ◆ Under extreme conditions, battery leakage may occur. When you notice liquid on the batteries carefully wipe the liquid off using a cloth. Avoid skin contact.
- ◆ In case of skin or eye contact, follow the instructions below.

**Warning!** The battery fluid may cause personal injury or damage to property. In case of skin contact, immediately rinse with water. If redness, pain or irritation occurs seek medical attention. In case of eye contact, rinse immediately with clean water and seek medical attention.

## Chargers

Your charger has been designed for a specific voltage. Always check that the mains voltage corresponds to the voltage on the rating plate.

**Warning!** Never attempt to replace the charger unit with a regular mains plug.

- ◆ Use your Black & Decker charger only to charge the battery in the appliance with which it was supplied. Other batteries could burst, causing personal injury and damage.
- ◆ Never attempt to charge nonrechargeable batteries.
- ◆ If the supply cord is damaged, it must be replaced by the manufacturer or an authorised Black & Decker Service Centre in order to avoid a hazard.
- ◆ Do not expose the charger to water.
- ◆ Do not open the charger.
- ◆ Do not probe the charger.
- ◆ The appliance/battery must be placed in a well ventilated area when charging.

## Electrical safety

### Symbols on the charger

 Read all of this manual carefully before using the appliance.

 This tool is double insulated; therefore no earth wire is required. Always check that the power supply corresponds to the voltage on the rating plate.

 Short circuit proof safety isolating transformer. The mains supply is electrically separated from the transformer output.

 130°C

The charger automatically shuts off if the ambient temperature becomes too high. As a consequence the charger will be inoperable. The charging base must be disconnected from the mains supply and taken to an authorised service centre for repair.



The charging base is intended for indoor use only.

## Features

This tool includes some or all of the following features.

1. On/off power switch
2. Handle
3. Extending flexible tube
4. Nozzle
5. Accessory release clip
6. LED charging indicator
7. Dust bowl door
8. Dust bowl
9. 2-in-1 combi nozzle accessory
10. Crevice tool
11. Pet tool
12. On/off power switch
13. Rotary brush on/off switch
14. Stick vacuum chassis
15. Floor head
16. Charging base
17. Accessory Holder

**Note:** The pet tool (11) is for cleaning up pet hair and must not be used directly on the animal.

## Battery



There are no user servicable part inside. For safe recycling of the battery and internal components please return the unit to an authorised Black&Decker service centre.

## Maintenance

Your Black & Decker cordless appliance has been designed to operate over a long period of time with a minimum of maintenance. Continuous satisfactory operation depends upon proper tool care and regular cleaning.

**Warning!** Before performing any maintenance on cordless appliances:

- ◆ Run the battery down completely if it is integral and then switch off.
- ◆ Unplug the charger before cleaning it. Your charger does not require any maintenance apart from regular cleaning.
- ◆ Regularly clean the ventilation slots in your appliance/charger using a soft brush or dry cloth.
- ◆ Regularly clean the motor housing using a damp cloth. Do not use any abrasive or solvent-based cleaner.

## Protecting the environment



Separate collection. This product must not be disposed of with normal household waste.

Should you find one day that your Black & Decker product needs replacement, or if it is of no further use to you, do not dispose of it with household waste. Make this product available for separate collection.



Separate collection of used products and packaging allows materials to be recycled and used again. Re-use of recycled materials helps prevent environmental pollution and reduces the demand for raw materials.

Local regulations may provide for separate collection of electrical products from the household, at municipal waste sites or by the retailer when you purchase a new product.

## Service Information

Black & Decker offers a full network of company-owned and authorized service locations throughout Asia. All Black & Decker Service Centers are staffed with trained personnel to provide customers with efficient and reliable product service.

Whether you need technical advice, repair, or genuine factory replacement parts, contact the Black & Decker location nearest to you.

## NOTE

- ◆ Black & Decker's policy is one of continuous improvement to our products and, as such, we reserve the right to change product specifications without prior notice.
- ◆ Standard equipment and accessories may vary by country.

- ◆ Product specifications may differ by country.
- ◆ Complete product range may not be available in all countries. Contact your local Black & Decker dealers for range availability.

## Technical data

		SVFV3250L (H1)	SVFV3250LR (H1)
Voltage	$V_{dc}$	32.4	32.4
Battery	Typ.	Li-Ion	Li-Ion
Weight	kg	3.58	3.58

Charger		ETPCA-405050WC	
Input voltage	$V_{ac}$	220	
Output voltage	$V_{dc}$	40	
Current	mA	500	
Approximate charge time	h	4	
Weight	kg	0.68	



## Troubleshooting

LED patens		Solution
■ ■ ■ ■ ■ ■ ■ ■	Battery hot	Allow to cool before continuing.
LED Patern : charging		Solution
■ ■ ■ ■ ■ ■ ■ ■	Battery fault	- Ensure correct charger is being used. Retry charging procedure. If fault continues, return unit to an authorised Black & Decker service centre.
■ ■ ■ ■ ■ ■ ■ ■	Charger fault	

## 设计用途

Black & Decker Dustbuster® 手持式吸尘器设计用于真空吸尘用途。本吸尘器仅适用于家庭用途。



使用设备前，请仔细阅读本手册。

## 安全说明

### **警告！请仔细阅读所有安全警告和说明。**

如不遵守以下任何警告和说明，可能会导致触电、火灾和/或严重伤害。

 **警告！** 使用电池供电的设备时，请务必始终遵守下列基本安全预防措施，从而降低火灾、触电、人身伤害和材料损坏等风险。

- ◆ 使用设备前，请仔细阅读本手册。
- ◆ 本手册描述了设备的设计用途。如果配件或附件的使用、本设备的操作超出本手册建议的范围，则可能出现人身伤害的危险。
- ◆ 请保存好本手册，以备将来查阅。

## 使用设备时

- ◆ 请不要使用本吸尘器吸水或其他液体或任何可能会引起火灾的材料。
- ◆ 请不要在靠近水的地方使用本吸尘器。

- ◆ 请勿将设备浸入水中。
- ◆ 切勿猛力拉扯充电器以使充电器脱离电源。请确保充电器远离热源、油脂及尖锐的边缘。
- ◆ 本设备不适合体力、感官或智力不足以及缺乏经验、知识的人员（包括儿童），除非负责他们安全的人员已经为他们提供关于使用此设备的监督或指示。确保儿童没有耍玩本设备。在没有他人监督的情况下，禁止儿童使用本设备或对其进行维护保养。

此产品为手持式器具，不使用时需将产品放回原充电位置并且靠近墙壁。以减少因误操作引起的产品倾倒

## 检查与维修

- ◆ 使用前，请检查设备是否受损或存在缺陷部件。检查部件是否破裂、开关是否损坏，以及是否存在影响设备操作的其它情况。
- ◆ 如果部件损坏或存在缺陷，请勿使用设备。
- ◆ 损坏或缺陷部件必须交由授权维修代理处维修与更换。
- ◆ 定期检查充电器导线是否损坏。如导线损坏或有缺陷，请更换充电器。
- ◆ 禁止试图拆卸或更换本手册规定之外的任何部件。

## 附加安全说明

### 使用后

- ◆ 清洁充电器或充电底座前，请拔下充电器。
- ◆ 不使用设备时，应存放于干燥场所。
- ◆ 应将设备存放在儿童接触不到的地方。

### 其他风险

使用工具时，可能出现本安全警示之外的其他风险。这些风险可能来自使用不当、使用时间过长等。尽管遵守了相关的安全法规并采用了安全装备，某些其他风险仍然是无法避免的。这些风险包括：

- ◆ 接触旋转/移动部件时的伤害风险。
- ◆ 更换部件、锯片或配件时的伤害风险。
- ◆ 长期使用工具的伤害风险。长期使用任何工具时，均应定期休息。
- ◆ 听力损伤。
- ◆ 吸入工具使用过程中产生的粉尘导致的健康危害（例如，锯切木材，特别是橡木、山毛榉和中密度纤维板时）。

## 电池和充电器

### 电池

- ◆ 不论基于任何理由，都不要尝试打开电池。
- ◆ 不要将电池暴露在水中。
- ◆ 不要将电池暴露在热源中。
- ◆ 不要将电池存放在温度可能超过 40° C 的地方。
- ◆ 只在环境温度介于 10° C 和 40° C 之间的情况下充电。
- ◆ 只能使用本设备随附的充电器为电池充电。使用错误的充电器可能会导致触电或电池过热。
- ◆ 处理电池时，请遵循“保护环境”部分所提供的说明进行。
- ◆ 请勿通过刺破或摔打方式损坏电池组或改变其形状，因为这可能会造成人身伤害或火灾危险。
- ◆ 不要对损坏的电池充电。
- ◆ 在极端条件下，电池可能会发生泄漏。如果您发现电池上有液体，请用布仔细拭去液体。避免皮肤接触。
- ◆ 如果与皮肤或眼睛接触，请按照下面的说明操作。

### 警告！

电池液可能会导致人身伤害或财产损失。如果与皮肤接触，请立即用清水冲洗。如果出现红肿、疼痛或刺激，请就医。如果与眼睛接触，请立即用清水冲洗并就医。

## 充电器

您的充电器专门设计用于特定电压。请务必检查电源电压是否与铭牌一致。

**警告！** 切勿尝试使用一般的电源插头替换充电器。

- ◆ 只能使用随附的 Black & Decker 充电器为设备内的电池充电。其他非原厂电池可能会爆裂，导致人身伤害和损害。
- ◆ 切勿尝试为不可再充电的电池充电。
- ◆ 如果电源线已损坏，必须让制造商或 Black & Decker 授权维修中心更换以避免发生危险。
- ◆ 不要将充电器暴露在水中。
- ◆ 不要打开充电器。
- ◆ 不要刺破充电器。
- ◆ 充电时，设备/工具/电池必须放在通风良好的地方。



充电器会在温度环境变得太高时自动关闭。因此，充电器将无法使用。充电底座必须断开主电源，并送到授权的服务中心进行维修。



充电底座仅供室内使用。

## 功能部件

本工具包含如下部分或全部部件。

1. 电源开关
2. 手柄
3. 延长软管
4. 吸嘴
5. 配件释放夹
6. LED 充电指示灯
7. 集尘仓门
8. 集尘仓
9. 二合一组合吸嘴配件
10. 细缝吸嘴
11. 宠物吸嘴
12. 电源开关
13. 旋转刷头开/关
14. 棍式吸尘器底座
15. 地板头
16. 充电底座
17. 配件夹持器

**注：** 宠物吸嘴 (11) 用于清洁宠物毛发，切勿直接用于动物身上。

## 电池



这些组件内没有可供用户维修的零件。为了安全回收电池和内部组件，请将本设备送回 Black & Decker 授权服务中心。

## 电气安全

### 充电器上的符号



使用设备前，请仔细阅读本手册。



本工具采用双重绝缘，因此无需接地线。请务必检查电源电压是否与铭牌上的电压一致。



短路保护安全隔离变压器。主电源与变压器输出具有电气隔离。

## 维护

Black & Decker 无线设备设计精良，可以长期使用，而且只需最少的维护。要连续获得令人满意的工作效果，需要进行合适的工具维护和定期清洁。

**警告！** 对无线设备进行任何维护工作之前，必须：

- ◆ 如果设备配有一体式电池，请将电池电量耗尽，然后再关闭电源。
- ◆ 清洁之前将充电器拔下。除了定期清洁外，本充电器无需其他保养。
- ◆ 定期使用软刷或干布清洁设备/充电器内的通风槽。
- ◆ 定期使用湿布清洁电动机外壳。请不要使用任何研磨性或基于溶剂的清洁剂。

## 保护环境



分类回收。本产品不得与普通家庭垃圾一起处理。

如果您发现您的 Black & Decker 产品需要进行替换，或您已经不再需要使用这些产品，请勿将它们与家庭废物一起处理。请将它们单独分类回收。



分类回收使用过的产品和包装能够让材料得以再循环和再利用。  
再生材料的再利用有助于防止环境污染，并降低对原材料的需求。

当地法规可能要求由市政废物处理点或向您出售新产品的零售商提供从家庭中分类回收电气产品的服务。

## 服务信息

Black & Decker 提供覆盖整个亚洲的公司隶属和授权服务地点。所有的 Black & Decker 服务中心都具有训练有素的人员，为客户提供高效和可靠的产品服务。

不论您是需要技术建议、维修或原厂替换部件，请联系最靠近您的 Black & Decker 地点。

## 注

- ◆ Black & Decker 的政策是持续改进我们的产品，因此，我们保留随时更改产品规格的权利，恕不另行通知。
- ◆ 标准设备和配件可能会因为不同的国家而有所不同。
- ◆ 产品规格可能会因为不同的国家而有所不同。
- ◆ 并非所有的国家都有提供完整的产品系列。当地法规可能要求由市政废物处理点或向您出售新产品的零售商提供从家庭中分类回收电气产品的服务。

## 技术参数

		SVFV3250LR (H1)	SVFV3250L (H1)
电压	伏特 <sub>(直流)</sub>	32.4	32.4
电池	类型	锂电	锂电
重量	千克	3.58	3.58

充电器		ETPCA-405050WC	
输入电压	伏特 <sub>(交流)</sub>	220	
输出电压	伏特 <sub>(直流)</sub>	40	
电流	毫安	500	
大约充电时间	小时	4	
重量	千克	0.68	

## 故障排除

LED 模式		解决方案
■ ■ ■ ■ ■ ■ ■ ■	电池温度高	冷却后再继续。
LED 模式：充电中		解决方案
■ ■ ■ ■ ■ ■ ■ ■	电池故障	- 确保使用正确的充电器。重试充电程序。若故障继续存在，请将设备送回到授权的 Black & Decker 服务中心。
■ ■ ■ ■ ■ ■ ■ ■	充电器故障	

